

Hikaria™ Series Outdoor Architectural Lighting

Catalogue 2023





Our Products...



CONTENTS

INGROUND LIGHTS
SERIES

38-221

DECK LIGHTS/
WATERPROOF
DOWNLIGHT
SERIES

222-241

UNDERWATER LIGHTS
SERIES

242-265

GARDEN SPOT LIGHTS
SERIES

266-305

WALL LIGHTS
SERIES

306-353

LED PROJECTOR
LIGHTING
SERIES

354-375

LED WALL WASHER

376-389

XLINEAR LIGHTS
SERIES

390-399

LED HANDRAIL LIGHTS
SERIES

400-404

ACCESSORIES

376-389

INGROUND LIGHTS SERIES

1.1 GROUND DECORATION INGROUND LIGHTS SERIES				
	UL-1006-0300-B (1) 48	UL-1006-0300-B (2) 49	UL-1006-0300-B (3A) 50	UL-1006-0300-B (3B) 51
	UL-1006-0300-B (4) 54	56	UL-D001-0600-B 57	58
	UL-E001-0400-A / UL-E001-0400-B 62	UL-E003-0300-A 63	UL-E003-0300(RGB)-A 64	UL-1002-0300-A 65
	UL-1014-0200-C 68	69	70	71
	UL-1014-0200 (RGB)-B 73	UL-6005-0600-A (LOGO) 74	76	77
UL-1021-0300-A-C3 / UL-1021-0300-A-C4 81	UL-3W-FX-0300-I 84	UL-6W-FX-0600-I 85	UL-9W-FX-0900-I 86	
UL-12W-FX-1200-I 87				

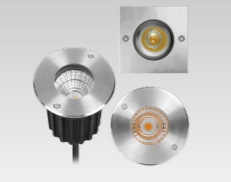
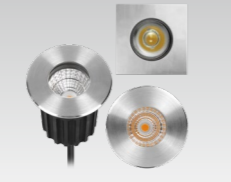


1.2 SMD LED GROUND SPOT SERIES				
	UL-1007-0100-B 92	UL-1007-0100-B-S 93	UL-1001-0300-B 94	UL-1001-0300-B-S 95
	UL-1003-0300-A 96	UL-1003-0300-A(B trim) 97	UL-1015-0300-A 98	UL-1008-0500-B 100
	102	UL-3005-0300-A 104	UL-6001-0900-I 105	UL-9001-1200-I 106
	UL-3001-0900-A 109	UL-3001-1000-B 110	UL-6002-1800-BH 112	UL-1202-2400-AH 113
	UL-2402-4000-AH 115	UL-1024-0300-A 116	UL-8W-COB-0800-D 118	UL-12W-COB-1200-D 119
1.3 ADJUSTABLE DIRECTION GROUND SPOT SERIES				
	UL-4001-0400-C 124	UL-6001-0600-C 125	UL-9001-0900-C 126	UL-1201-1200-C 127
	UL-9002-1800-A 128	UL-6W-COB-0600-G 129	UL-12W-COB-1200-C 130	UL-1205-1500-AH 134

**1.4
GU10 /MR16
GROUND SPOT
SERIES**

 UL-GU10-A 140	 UL-GU10-LC 141	 UL-GU10-C 142	 UL-MR16-A 143
---	--	--	---

 UL-MR16-LC 144	 UL-MR16-C 145	 UL-GU10-A-S 146	 UL-GU10-D 148
--	---	---	--

**1.5
COB LED
GROUND SPOT
SERIES**

 Round trim: UL-6W-COB-0600-B Square trim: UL-6W-COB-0600-B-S 152	 Round trim: UL-6W-COB-0600-F Square trim: UL-6W-COB-0600-F-S 153	 Round trim: UL-6W-COB-0600-CH Square trim: UL-6W-COB-0600-CH-S 155	 UL-9W-COB-0900-B 156
---	---	--	--

 Round trim: UL-12W-COB-1200-AH Square trim: UL-12W-COB-1200-AH-S 157	 Round trim: UL-15W-COB-1500-AH Square trim: UL-15W-COB-1500-AH-S 158	 UL-25W-COB-2500-AH 159	 UL-25W-COB-2500-EH 160	 UL-36W-COB-3600-AH 162
--	--	---	--	---

 UL-50W-COB-5000-AH 163	 UL-1020-0500-A 164	 UL-6W-COB-0600-I 165	 UL-9W-COB-0900-I 167	 UL-12W-COB-1200-I 168
--	--	--	---	---

 UL-15W-COB-1500-I 169

**1.6
ASYMMETRIC SMD
LED GROUND
SPOT SERIES**

 UL-1009-0300-C 175	 UL-1008-0500-B 178	 UL-6001-0900-I 179	 UL-9001-1200-I 180
--	--	---	--


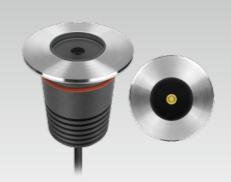


 UL-1201-1500-I 181	 UL-1801-3000-AH 182	 UL-2401-4000-BH 183
--	---	---

**1.7
ASYMMETRIC COB
LED GROUND
SPOT SERIES**

 UL-15W-COB-1500-DH 187	 UL-25W-COB-2500-CH 188	 UL-36W-COB-3600-BH 189	 UL-1013-0700-A 193
--	--	--	--

 UL-30W-COB-3000-BH 194	 UL-6W-COB-0600-CH (HOOD TRIM) 198	 UL-6W-COB-0600-F (Half glass black) 199	 UL-9W-COB-0900-B (Half glass black) 200	 UL-15W-COB-1500-AH (Half glass black) 201
--	---	---	---	---

**1.8
DEPTH ILLUMINANT
ANTI-GLARE
GROUND SPOT SERIES**

 UL-1026-0300-A 204	 UL-1026-0500-A 205	 UL-4001-0600-E 208	 UL-9001-1200-E 209
---	---	---	---

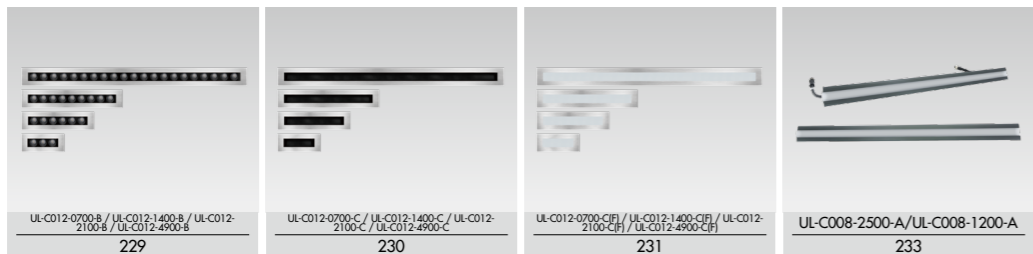
 UL-15W-COB-1500-GH 212	 UL-3003-1500-BH 213
--	---

**1.9
ZOOMABLE
COB LED GROUND
SPOT SERIES**

 UL-8W-COB-0800-J 216	 AC100-245V UL-15W-COB-1500-J DC24V/UL-15W-COB-1500-J 218
--	---

**1.10
LINEAR INGROUND
LIGHT SERIES**

 48W: UL-C010-4800-A / 96W: UL-C011-9600-A 225	 UL-C001-0700-AH 226	 UL-C001-0700-AH (frosted glass) 227	 UL-C012-0700-A / UL-C012-1400-A / UL-C012-2100-A / UL-C012-4900-A 228
---	---	---	---



1.11
RGB/RGBW
GROUND SPOT
SERIES



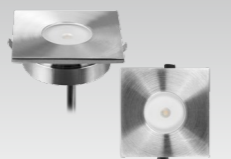








1.12
SOLAR POWERED
DECORATION
INGROUND LIGHT
SERIES



ILLUMINATING ASIA



DECK LIGHTS/WATERPROOF DOWNLIGHT SERIES

2.1 DECK LIGHTS/ WATERPROOF DOWNLIGHT SERIES				
				
				
				



UNDERWATER LIGHTS SERIES

3.1 GENERAL RECESSED UNDERWATER LIGHTS SERIES				
	UL-1011-0100-A-316 280	UL-1011-0100 (RGB)-A 281	UL-1009-0300-C-316 282	UL-3006-0500-A / UL-3006-0700-A 284
				
UL-3006-0900 (RGB)-A 285	UL-6003-1200-A / UL-6003-1800-A 288	UL-6003-1800 (RGB)-A / UL-6003-1800-RGBW-A 289		
3.2 SURFACE MOUNTED UNDERWATER LIGHTS SERIES				
	UL-6004-0600-A 291	UL-6004-0600-RGB-A 292	SL-3601-(RGB) 293	
3.3 MARINE SERIES (COPPER HOUSING)				
	SL-6005-1500-A 296	SL-1201-2400-C 298		
3.4 STANDING SURFACE MOUNTED UNDERWATER LIGHTS SERIES				
	SL-1004-0300-A 299	SL-1004-0300-RGBW-A 300	SL-1010-0800-A 301	SL-1010-0800-RGBW-A 302
				
SL-15W-COB-1500-A 303	SL-15W-COB-1500-RGBW-A 304	SL-6001-1200-B 305	SL-6001-1200 (RGBW)-B 306	



GARDEN SPOT LIGHTS SERIES

4.1 GENERAL GARDEN SPOT LIGHTS SERIES	 UL-1004-0300-A 312	 UL-4002-0400-A 313	 UL-1010-0500-BH 314	 UL-1010-0500-CH 315	
	 UL-1010-0500-CH 318	 UL-1010-0800-AH / UL-1010-0800-BH 319	 UL-1012-1200-AH 320	 UL-1012-1800-AH 321	 UL-15W-COB-1500-BH 322
	 UL-1019-1200-BH 323	 UL-1019-1200-AH 326	 UL-8W-COB-AH / UL-8W-COB-0800-AH 327	 UL-25W-COB-2500-BH 328	
	4.2 DEPTH ILLUMINANT GARDEN SPOT LIGHT SERIES				
	 DC12-24V UL-8W-COB-0800-K AC100-265V UL-8W-COB-0800-KH 329				
4.3 ZOOMABLE GARDEN SPOT LIGHTS SERIES	 UL-8W-COB-0800-FH(PULL) 330	 UL-12W-COB-1200-BH 331	 UL-18W-COB-1800-FH(PULL) 332	 UL-25W-COB-2500-FH(PULL) 333	
	 UL-8W-COB-0800-FH (ROTATE) 334	 UL-18W-COB-1800-FH (ROTATE) 335	 UL-25W-COB-2500-FH (ROTATE) 336		

4.4 MULTIPLE HEAD GARDEN SPOT LIGHTS SERIES	 UL-1018-1500-A 337	 UL-1010-0500-EH 340	 UL-1010-0500-EH(LT-08) 341	 UL-15W-COB-1200-EH 343
	 UL-1010-0600-RGB-A 345	 UL-1010-0500 (RGBW)-A 346	 UL-1012-1200 (RGBW)-A 347	 UL-1010-0500(RGBW)-B(WIFI) 348
4.5 RGB,RGBW GARDEN SPOT LIGHTS SERIES	 UL-1012-GU10-A-70 350	 UL-1012-GU10-A 351	 UL-1012-MR16-A-54 352	
	4.6 GU10, MR16 GARDEN SPOT LIGHTS SERIES			
4.7 LED LAWN LIGHT	 LL-4801-0900-A 354	 LL-4801-0700-AH 356	 LL-4801-0200-A (SOLAR) 357	
	4.8 POLE FOR GARDEN SPOT LIGHTS SERIES			
 POLE FOR GARDEN SPOT LIGHTS SERIES 360		 UL-1010-0800-AH with Pole / UL-15W-COB-1500-BH with Pole / UL-12W-COB-1200-BH with Pole 361		
Optional Accessories for Garden Spot Lights Series Spike				
366 - 367				
4.9 REED LIGHTING SERIES	 LL-1001-0100-B 368	 AC100-265V LL-1001-0300-CH DC12V-24V LL-1001-0300-C 370		

4.10
LANDSUN
SERIES







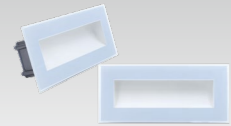


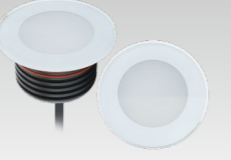

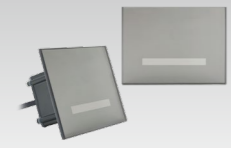
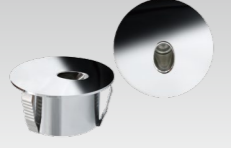
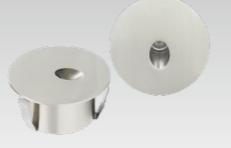












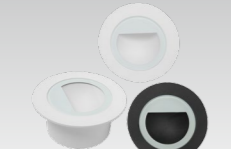
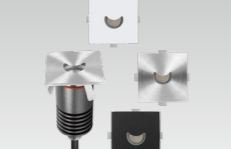


4.11
PLAYBALL
SERIES



ILLUMINATING ASIA



WALL LIGHTS SERIES

5.1 GENERAL WALL LIGHTS SERIES	 SP-001-0400-AH 384	 SP-005-0800-AH 385	 SP-003-0400-AH 386	 SP-001-0300-BH 387
 SP-005-0500-BH 388	 SP-004-0500-B 389	 SP-004-1000-A 390	 SP-004-1000-RGB-A 391	 SP-011-1000-A 394
 SP-009-0500-BH 396	 DC: SP-006-0300-A PC / AC: SP-006-0300-AH PC 400	 DC: SP-006-0300-A SN / AC: SP-006-0300-AH SN 401	 DC: SP-006-0300-A PW / AC: SP-006-0300-AH PW 402	 DC: SP-006-0300-A (Black) / AC: SP-006-0300-AH (Black) 403
 DC: SP-006-S-0300-A (White) / AC: SP-006-S-0300-AH (White) 404	 DC: SP-006-S-0300-AH (Black) / AC: SP-006-S-0300-AH (Black) 405	 DC: SP-007-0300-A PC / AC: SP-007-0300-AH PC 407	 DC: SP-007-0300-A SN / AC: SP-007-0300-AH SN 408	 DC: SP-007-0300-A PW / AC: SP-007-0300-AH PW 409
 SP-015-0100-AH PC 412	 SP-015-0100-AH PW 413	 SP-015-0100-AH SN 414	 SP-016-0300-A 415	 UL-C001-0700-AH 420
 SP-014-0300-A 421	 UL-1003-0300-A(C trim)3 Watts 422	 UL-1003-0300-A(D trim) 423	 UL-6W-COB-0600-CH (HOOD TRIM) 424	

5.2 TOUCHED CONTROLLED WALL LIGHTS SERIES	 SP-008-0400-AH-TOUCH 426			
5.3 EMERGENCY WALL LIGHTS SERIES	 SP-001-0400-E 428	 SP-005-0800-E 429		
5.4 BOLLARD LIGHTS WITH REPLACEABLE WALL LIGHTS SERIES	 BL-003 430			
5.5 WINDOW LIGHTS SERIES	 UL-3001-0500-CH 431	 UL-3001-0500-RGBW-C 433	 AC100-265V:UL-3001-0700-EH DC24V: UL-3001-0700-E 435	
5.6 PLAYWALL SERIES	 DC12-24V: WL-3001-0300-B / AC100-265V: WL-3001-0300-BH 438	 DC12-24V: WL-6001-0700-B / AC100-265V: WL-6001-0700-BH 439	 WL-9W-COB-0900-AH 440	 WL-18W-COB-1800-AH 441
 DC24V: UL-E001-0400-A (Ø8mm) / AC100-265V: UL-E001-0400-AH (Ø8mm) 443				

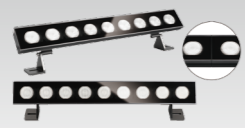
LED PROJECTOR LIGHTING SERIES

6.1 LED PROJECTOR LIGHTING SERIES				
	FL-7001-0700-AH / FL-7001-1400-AH 448	FL-1701-1700-AH / FL-1701-3400-AH 449	FL-3601-3600-AH / FL-3601-3600-RGB-A / FL-3601-5000-AH 450	FL-1201-1200-AH / FL-1201-2400-AH 451
				
FL-1201-1200-BH / FL-1201-2400-BH 452	FL-1201-1200-CH / FL-1201-2400-CH 453	FL-3001-0900-A 454	TGD-100150-9D 455	TGD-130130-24D 456
				
TGD-160160-36D 457	TGD-190170-48D 458	TGD-230200-72D 459	TGD-300250-100D 460	TGD-300250-130D 461

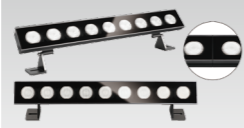


LED WALL WASHER AND LED LINEAR LIGHTS SERIES

7.1
LED WALL WASHER
SERIES



LWW-9001-4800-A / LWW-1801-9600-A
470



LWW-9001-RGBW-A / LWW-1801-RGBW-A
471



LWW-2401-1800-B
474



LWW-2401-2400-B
475

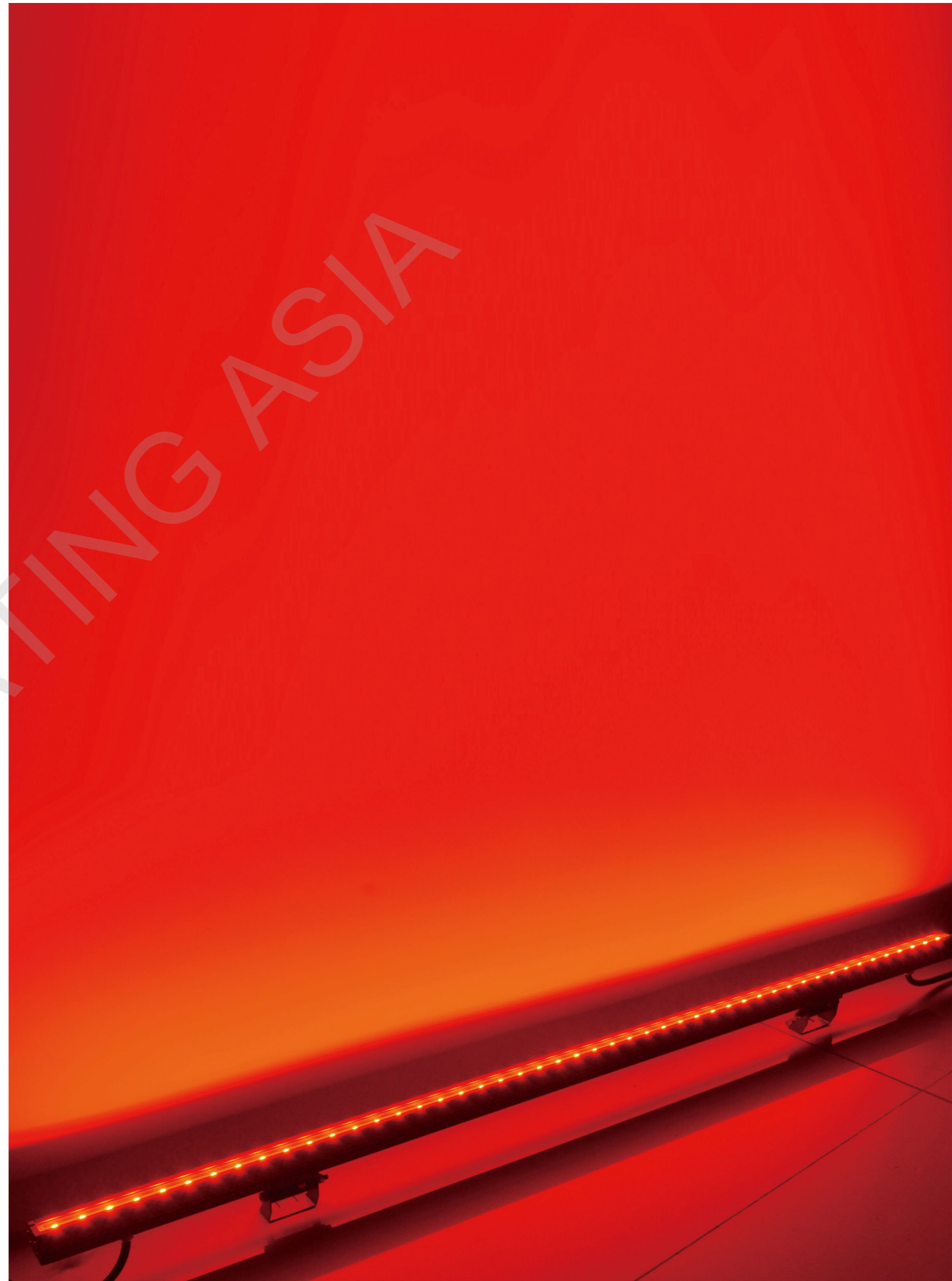


LWW-3601-3600-B
478



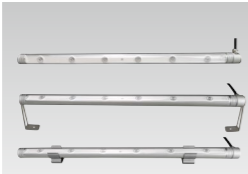
LWW-3601-4800-B
479

ILLUMINATING ASIA



XLINEAR SERIES

8.1
XLINEAR SERIES



SL-T8-0600-A
484



SL-T8-1200-B
485



SL-T8-1200-C
488



LED HANDRAIL LIGHTS SERIES

9.1
LED HANDRAIL
LIGHTS
SERIES



SSS304: DL-1014-0100-A-304 / AL: DL-1014-0100-A-3063
498



80°: DL-1016-0100-A / 10x60°: DL-1016-0100-B
500

ILLUMINATING ASIA



ACCESSORIES

10.1
ACCESSORIES



WRC-A-I
507



WRC-A-I (L)
508



WRC-A-T
509



WRC-C-Box
510





INGROUND LIGHTS SERIES

Products Features

These products are designed with stainless steel 316 trim, Solid 6063 Aluminum housing CNC machined, with passivated (anodizing) anti-corrosion finishing for housing, optics PMMA lens with wonderful light output, tempered glass for high loading capacity, silicone gasket and cable gland for waterproof IP67 and high quality CREE LED, OSRAM LED, EPISTAR LED.

We make wide range of inground lights to meet different application with different size, power, color, beam angle, and even the inground lights beam direction or beam angle adjustable series are available.

These products are with CE, RoHS certifications, and the SAA, PSE, UL or ETL certifications will be available in the coming future.

Application

These lights are widely used in the exterior or interior application, such as lighting columns, walls, architectural features, landscape features for the hotel, the garden, the park, the square, the stair step, the landscape road etc.

SSS 316

Adjustable

Passivated

1 Year Warranty



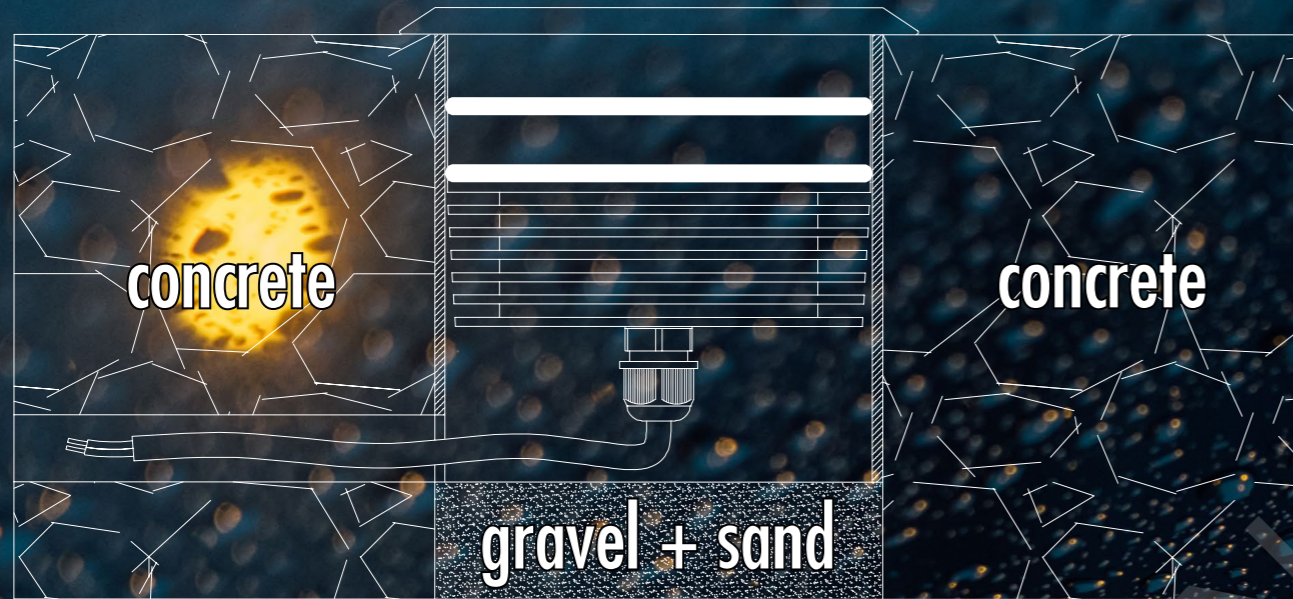
**IP67 IK06 IK07 IK08
IK09 IK10**



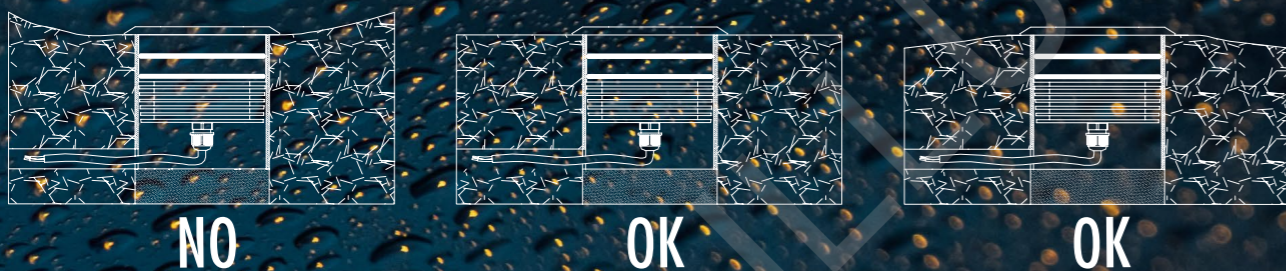
ILLUMINATING ASIA

Inground Lights Installation Warning !

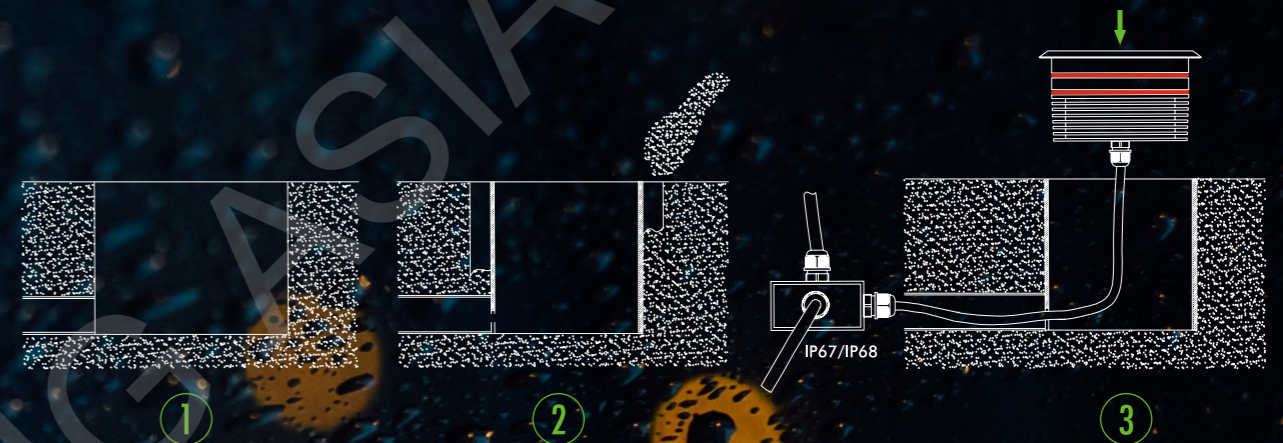
Please don't seal the bottom of the fixture by concrete so that the water is able to follow away from the earth when raining !
Please also provide proper drainage (sand, gravel) for sleeve so that fixtures will not be immersed in water.



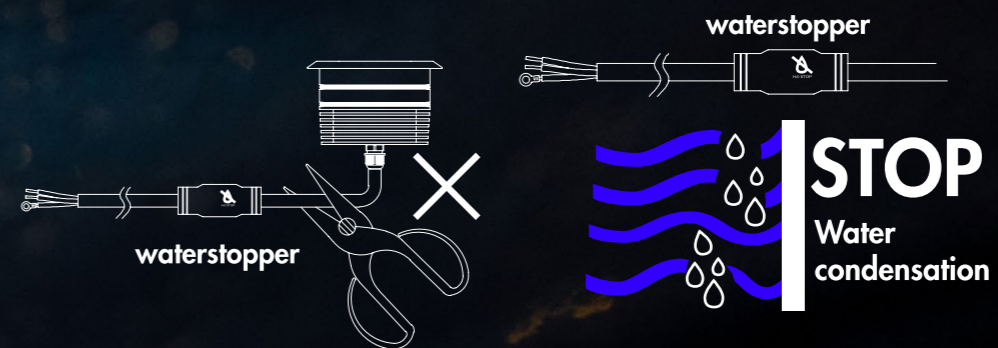
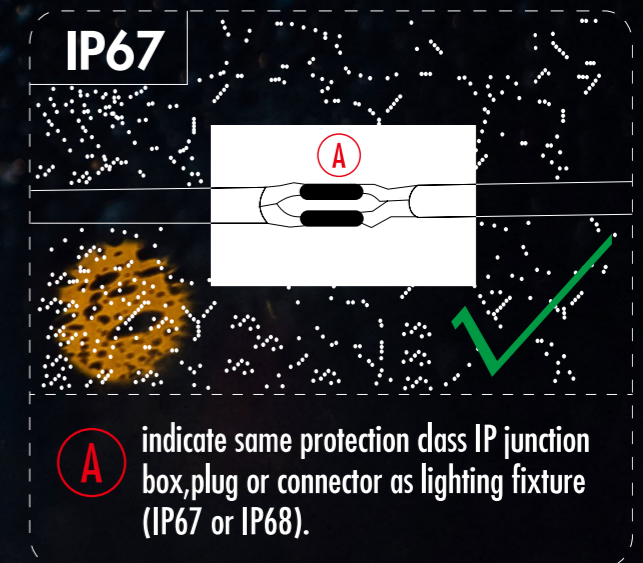
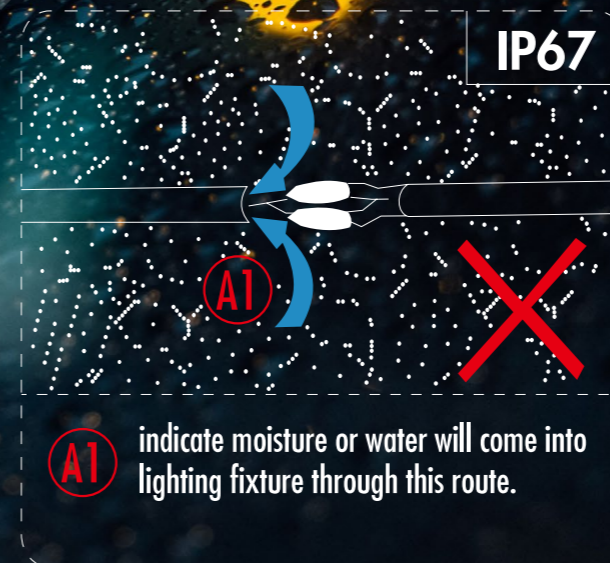
Do not locate fixtures in low areas where water will collect.



Inground Lights Installation Drawing



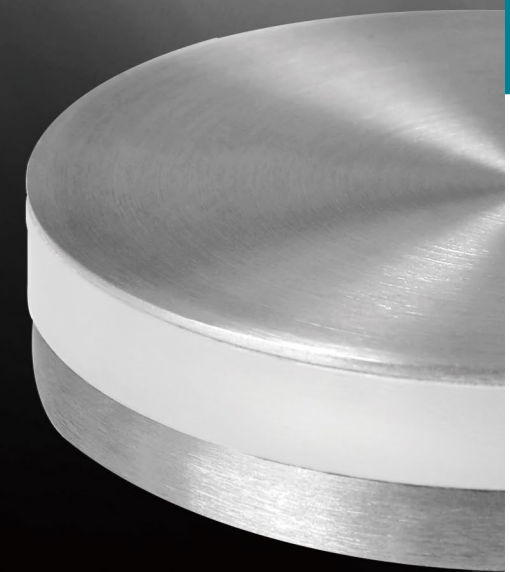
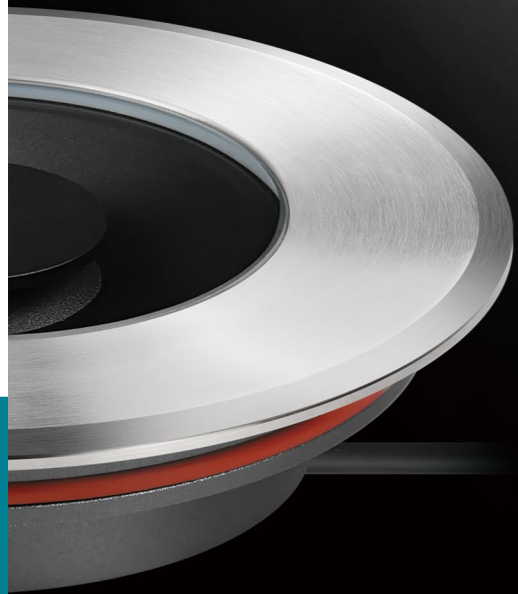
Please use the IP67 or IP68 waterproof connector or junction box for the connecting !



Don't cut the cable between the waterstopper and the lamp !

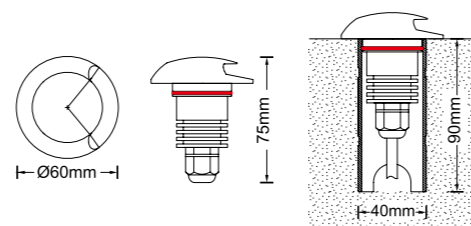
INGROUND LIGHTS SERIES

1.1 GROUND DECORATION INGROUND LIGHTS SERIES

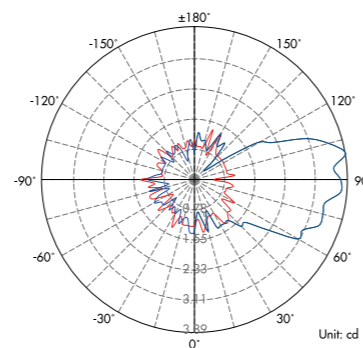




Dimension



Light Distribution Curve (3000K, 1x100°)



Lux distance Curve (3000K, 1x100°)

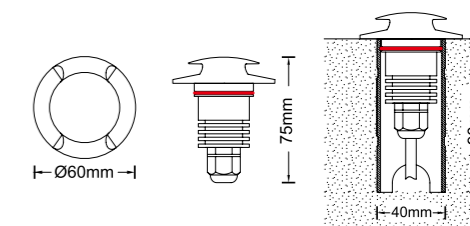
Distance (m)	Illuminance at a Distance	
	Center Beam LUX	Beam Width V x H
2m	0.30 LUX	9.6m x 1.4m
4m	0.07 LUX	19.3m x 2.8m
6m	0.03 LUX	28.9m x 4.2m
8m	0.02 LUX	38.6m x 5.6m
10m	0.01 LUX	48.2m x 6.9m
12m	0.01 LUX	57.8m x 8.3m

Vert.Spread:135.0H Horiz.Spread:38.3

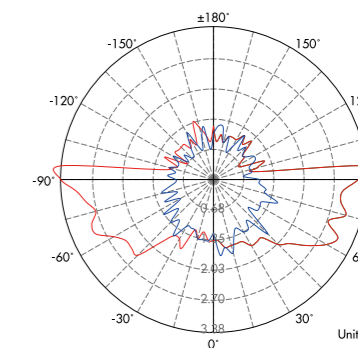
Illumination Picture (1x100°)



Dimension



Light Distribution Curve (3000K, 2x100°)

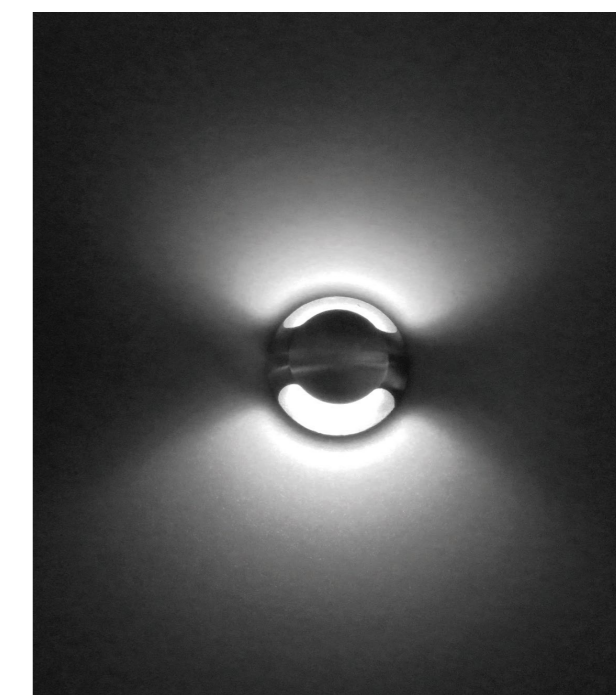


Lux distance Curve (3000K, 2x100°)

Distance (m)	Illuminance at a Distance	
	Center Beam LUX	Beam Width V x H
2m	0.34 LUX	2.8m x 0.0m
4m	0.08 LUX	5.6m x 0.0m
6m	0.04 LUX	8.4m x 0.0m
8m	0.02 LUX	11.2m x 0.0m
10m	0.01 LUX	14.0m x 0.0m
12m	0.01 LUX	16.8m x 0.0m

Vert.Spread:70.0H Horiz.Spread:0.0

Illumination Picture (2x100°)



CE RoHS COMPLIANT IP67 IK10

SSS 316 Passivated 1 Year Warranty

Parameter

General Data	
Item No.	UL-1006-0300-B (1)
Power	3 Watts
LED type	1 PC 3W CREE XPE LED
Luminous flux	95~100 lm
CCT	2700K, 3000K, 4000K, 6000K, R/G/Y/B
CRI	80+
Beam angle	1x100°
Dimension	60x75 (mm) Diameter x Height
Cut out	40 mm
Net weight	0.370 kgs
Warranty	1 year
Certifications	CE, RoHS
Electrical Data	
Input voltage	DC 12V~DC24V
Insulation class	Class III
Cable	1PC rubber cable 1M H05RN-F 2x1mm square
Driver	Low voltage constant current output, excluding the transformer
Construction Data	
IP rating	IP67 Waterproof
IK rating	IK10
Housing	Solid Passivated (Anodizing) Aluminum CNC machined
Protection finishing	20~25µm thickness anodized film for housing. Dark grey
Trim	Stainless steel 316
Glass	Step tempered Glass. T=4mm.
Loading capacity	≤2000kgs
Cable Gland	PG7 IP67
Gasket	O-ring PMQ silicone seal
Accessories	
Mounting Sleeve	Passivated (Anodizing) Aluminum CNC machined.Dark grey
Packaging	
Inner box size	117*83*65 mm
Carton size	43*25*28 cm (40PCS / carton)

CE RoHS COMPLIANT IP67 IK10

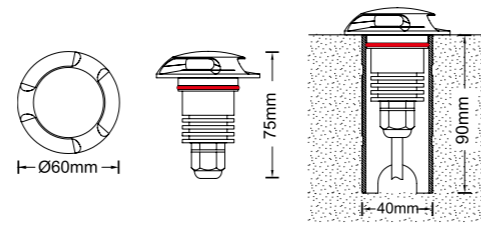
SSS 316 Passivated 1 Year Warranty

Parameter

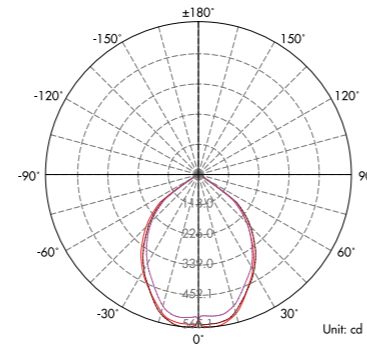
General Data	
Item No.	UL-1006-0300-B (2)
Power	3 Watts
LED type	1 PC 3W CREE XPE LED
Luminous flux	95~100 lm
CCT	2700K, 3000K, 4000K, 6000K, R/G/Y/B
CRI	80+
Beam angle	2x100°
Dimension	60x75 (mm) Diameter x Height
Cut out	40 mm
Net weight	0.341 kgs
Warranty	1 year
Certifications	CE, RoHS
Electrical Data	
Input voltage	DC 12V~DC24V
Insulation class	Class III
Cable	1PC rubber cable 1M H05RN-F 2x1mm square
Driver	Low voltage constant current output, excluding the transformer
Construction Data	
IP rating	IP67 Waterproof
IK rating	IK10
Housing	Solid Passivated (Anodizing) Aluminum CNC machined
Protection finishing	20~25µm thickness anodized film for housing. Dark grey
Trim	Stainless steel 316
Glass	Step tempered Glass. T=4mm.
Loading capacity	≤2000kgs
Cable Gland	PG7 IP67
Gasket	O-ring PMQ silicone seal
Accessories	
Mounting Sleeve	Passivated (Anodizing) Aluminum CNC machined.Dark grey
Packaging	
Inner box size	117*83*65 mm
Carton size	43*25*28 cm (40PCS / carton)



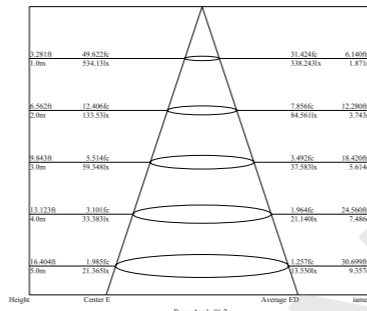
Dimension



Light Distribution Curve (3000K, 3x100°)



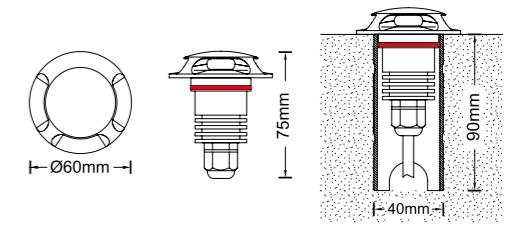
Lux distance Curve (3x100°)



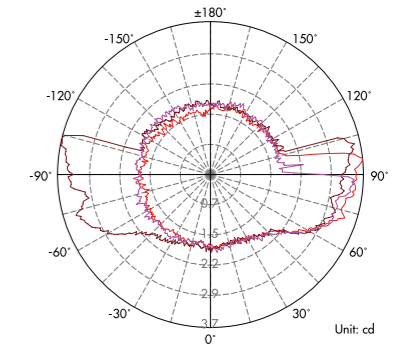
Illumination Picture (3x100°)



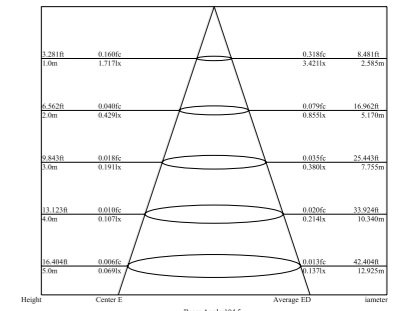
Dimension



Light Distribution Curve (3000K, 3x80°)



Lux distance Curve (3x80°)



Illumination Picture (3x80°)



CE RoHS COMPLIANT IP67 IK10

SSS 316 Passivated 1 Year Warranty

Parameter

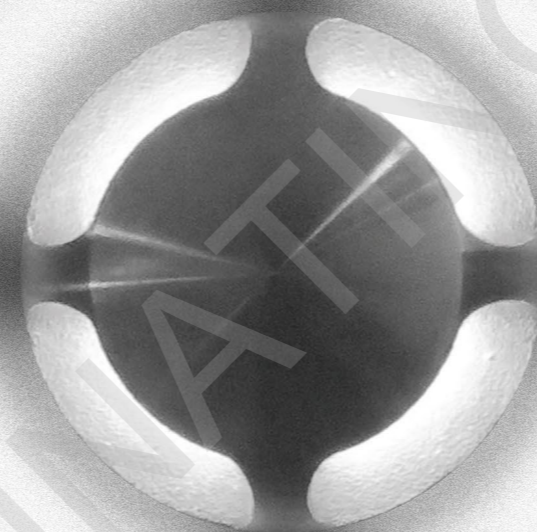
General Data	
Item No.	UL-1006-0300B (3A)
Power	3 Watts
LED type	1 PC 3W CREE XPE LED
Luminous flux	95~100 lm
CCT	2700K, 3000K, 4000K, 6000K, R/G/Y/B
CRI	80+
Beam angle	3x100°
Dimension	60x75 (mm) Diameter x Height
Cut out	40 mm
Net weight	0.327 kgs
Warranty	1 year
Certifications	CE, RoHS
Electrical Data	
Input voltage	DC 12V~DC24V
Insulation class	Class III
Cable	1PC rubber cable 1M H05RN-F 2x1mm square
Driver	Low voltage constant current output, excluding the transformer
Construction Data	
IP rating	IP67 Waterproof
IK rating	IK10
Housing	Solid Passivated (Anodizing) Aluminum CNC machined
Protection finishing	20~25µm thickness anodized film for housing. Dark grey
Trim	Stainless steel 316
Glass	Step tempered Glass. T=4mm.
Loading capacity	≤2000kgs
Cable Gland	PG7 IP67
Gasket	O-ring PMQ silicone seal
Accessories	
Mounting Sleeve	Passivated (Anodizing) Aluminum CNC machined. Dark grey
Packaging	
Inner box size	117*83*65 mm
Carton size	43*25*28 cm (40PCS / carton)

CE RoHS COMPLIANT IP67 IK10

SSS 316 Passivated 1 Year Warranty

Parameter

General Data	
Item No.	UL-1006-0300B (3B)
Power	3 Watts
LED type	1 PC 3W CREE XPE LED
Luminous flux	95~100 lm
CCT	2700K, 3000K, 4000K, 6000K, R/G/Y/B
CRI	80+
Beam angle	3x80°
Dimension	60x75 (mm) Diameter x Height
Cut out	40 mm
Net weight	0.352 kgs
Warranty	1 year
Certifications	CE, RoHS
Electrical Data	
Input voltage	DC 12V~DC24V
Insulation class	Class III
Cable	1PC rubber cable 1M H05RN-F 2x1mm square
Driver	Low voltage constant current output, excluding the transformer
Construction Data	
IP rating	IP67 Waterproof
IK rating	IK10
Housing	Solid Passivated (Anodizing) Aluminum CNC machined
Protection finishing	20~25µm thickness anodized film for housing. Dark grey
Trim	Stainless steel 316
Glass	Step tempered Glass. T=4mm.
Loading capacity	≤2000kgs
Cable Gland	PG7 IP67
Gasket	O-ring PMQ silicone seal
Accessories	
Mounting Sleeve	Passivated (Anodizing) Aluminum CNC machined. Dark grey
Packaging	
Inner box size	117*83*65 mm
Carton size	43*25*28 cm (40PCS / carton)

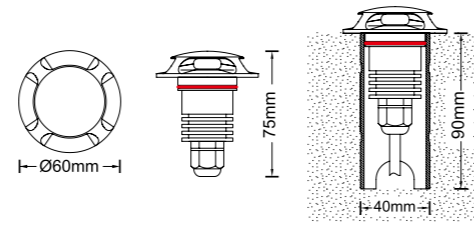


ILLUMINATION G (SIA)

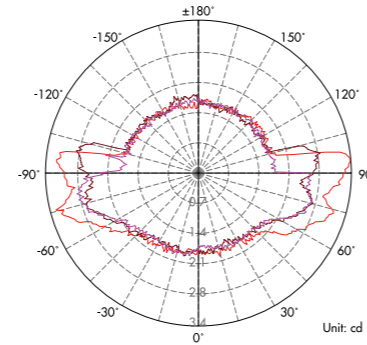




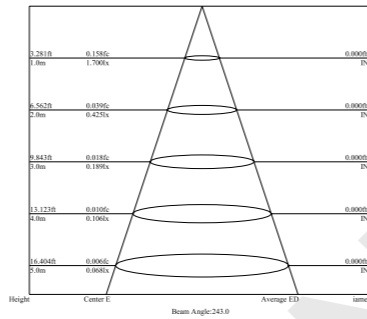
Dimension



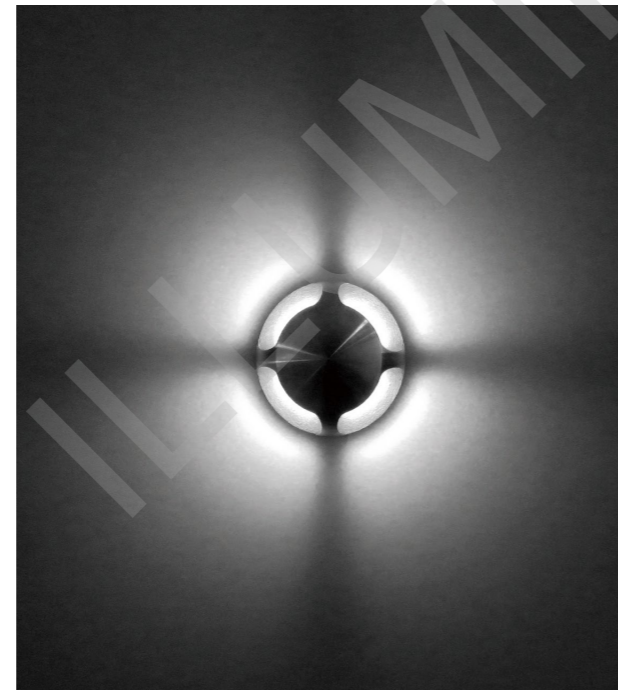
Light Distribution Curve (3000K, 4x80°)



Lux distance Curve (3000K, 4x80°)



Illumination Picture (4x80°)



CE RoHS COMPLIANT IP67 IK10

SSS 316 Passivated 1 Year Warranty

Parameter

General Data	
Item No.	UL-1006-0300-B (4)
Power	3 Watts
LED type	1 PC 3V CREE XPE LED
Luminous flux	95-100 lm
CCT	2700K, 3000K, 4000K, 6000K, R/G/Y/B
CRI	80+
Beam angle	4x80°
Dimension	60x75 (mm) Diameter x Height
Cut out	40 mm
Net weight	0.322 kgs
Warranty	1 year
Certifications	CE, RoHS
Electrical Data	
Input voltage	DC 12V-DC24V
Insulation class	Class III
Cable	1PC rubber cable 1M H05RN-F 2x1mm square
Driver	Low voltage constant current output, excluding the transformer
Construction Data	
IP rating	IP67 Waterproof
IK rating	IK10
Housing	Solid Passivated (Anodizing) Aluminum CNC machined
Protection finishing	20-25µm thickness anodized film for housing. Dark grey
Trim	Stainless steel 316
Glass	Step tempered Glass, T=4mm.
Loading capacity	≤2000kgs
Cable Gland	PG7 IP67
Gasket	O-ring PMQ silicone seal
Accessories	
Mounting Sleeve	Passivated (Anodizing) Aluminum CNC machined. Dark grey
Packaging	
Inner box size	117*83*65 mm
Carton size	43*25*28 cm (40PCS / carton)



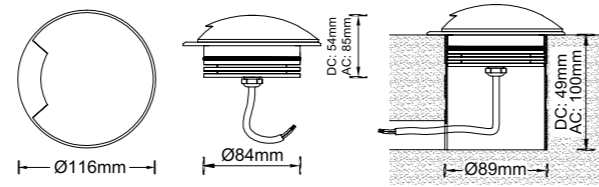


CE RoHS COMPLIANT IP67 IK10

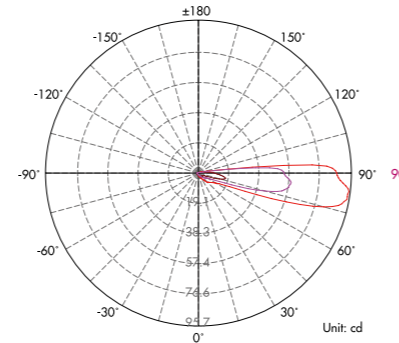
SSS 316 1 Year Warranty

Parameter	
General Data	
Item No.	DC24V version: UL-D001-0200B AC100-265V version: UL-D001-0200BH
Power	2 Watts +10%
LED type	1 PC 2W OSAM 3030 SMD LED
Luminous flux	43lm +10%
CCT	2700K, 3000K, 4000K, 6000K, R/G/Y/B
CRI	80+
Beam angle	1x 60°*90°
Dimension	
DC version:	Ø116x54 mm Diameter x Height
AC version:	Ø116 x 85 mm Diameter x Height
Cut out	89 mm
Net weight	1.2 kgs
Warranty	1 year
Certifications	CE, RoHS
Electrical Data	
Input voltage	DC24V (optional: AC100-265V)
Insulation class	Class III / Class I
Cable	1PC rubber cable 1M H05RN-F 2 or 3x1mm square
Driver	Low voltage input constant current output for LED (High voltage item optional)
Construction Data	
IP rating	IP67 Waterproof
IK rating	IK10
Housing	Solid Passivated (Anodizing) Aluminum CNC machined
Protection finishing	20~25µm thickness anodized film for housing. Dark grey
Trim	Stainless steel 316
Glass	/
Loading capacity	2000 kgs
Cable Gland	PG gland
Gasket	O-ring PMQ silicone seal
Accessories	
Mounting Sleeve	Passivated (Anodizing) Aluminum CNC machined. Dark grey
Packaging	
Inner box size	105*105*140 mm
Carton size	55*23*30.5 cm (20 PCS / carton)

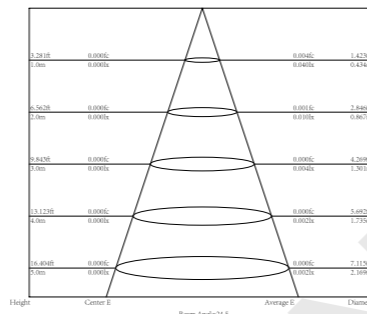
Dimension



Light Distribution Curve (3000K, 1x 60°*90°)



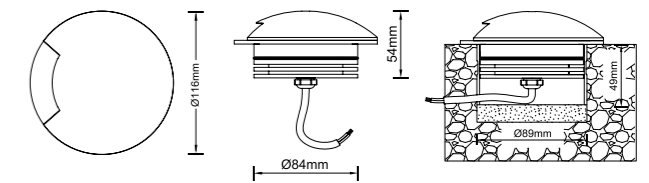
Lux distance Curve (3000K, 1x 60°*90°)



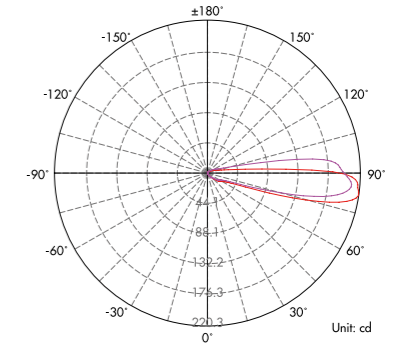
Illumination Picture (1x 60°*90°)



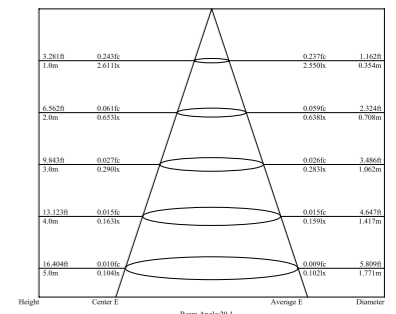
Dimension



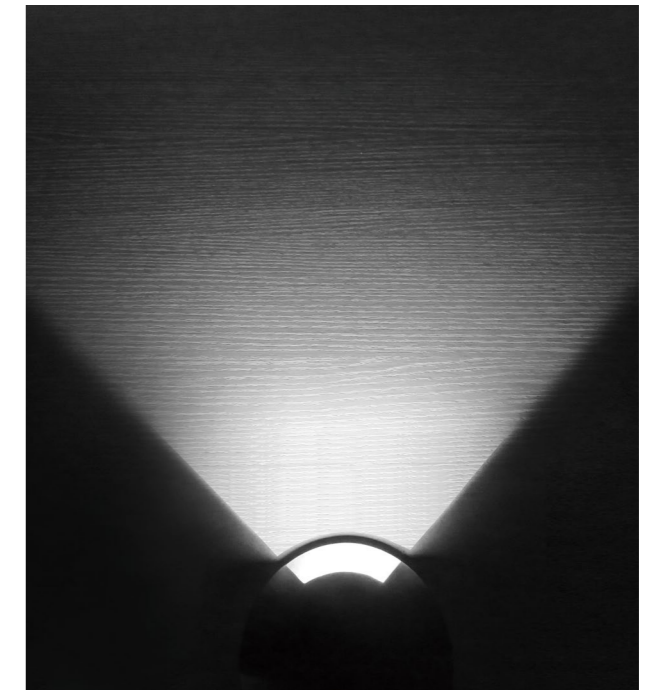
Light Distribution Curve (3000K, 1x 60°*90°)



Lux distance Curve (3000K, 1x 60°*90°)



Illumination Picture (1x 60°*90°)



CE RoHS COMPLIANT IP67 IK10

SSS 316 1 Year Warranty

Parameter	
General Data	
Item No.	UL-D001-0600B
Power	6 watts ± 10%
LED type	1 PC 6W CREE XHP35 LED
Luminous flux	140lm ± 10%
CCT	2700K, 3000K, 4000K, 6000K
CRI	80+
Beam angle	1x 60°*90°
Dimension	Ø116x54 (mm) Diameter x Height
Cut out	Ø89mm
Net weight	1.1 kgs
Warranty	1 year
Certifications	CE, RoHS
Electrical Data	
Input voltage	DC24V
Insulation class	Class III
Cable	1PC rubber cable 1M H05RN-F 2x1mm square
Driver	Low constant voltage input, constant current output driver for LED
Construction Data	
IP rating	IP67 Waterproof
IK rating	IK10
Housing	Solid Passivated (Anodizing) Aluminum CNC machined
Protection finishing	20~25µm thickness anodized film for housing. Dark grey
Trim	Stainless steel 316
Glass	/
Loading capacity	2000 kgs
Cable Gland	PG gland
Gasket	O-ring PMQ silicone seal
Accessories	
Mounting Sleeve	Passivated (Anodizing) Aluminum CNC machined. Dark grey
Packaging	
Inner box size	105*105*140 mm
Carton size	55*23*30.5 cm (20 PCS/carton)



CE RoHS COMPLIANT IP67 IK10

SSS 316 1 Year Warranty

Parameter

General Data

Item No.	DC24V version: UL-D002-0400-B AC100-264V version: UL-D002-0400-BH
Power	4 Watts +10%
LED type	2 PCS 2W OSAM 3030 SMD LED
Luminous flux	85lm +10%
CCT	2700K, 3000K, 4000K, 6000K, R/G/Y/B
CRI	80+
Beam angle	2x 60°*90°

Dimension DC version: Ø116x54 mm Diameter x Height
AC version: Ø116 x 85 mm Diameter x Height

Cut out	89 mm
Net weight	1.1 kgs
Warranty	1 year
Certifications	CE, RoHS

Electrical Data

Input voltage	DC24V (optional: AC100-265V)
Insulation class	Class III / Class I
Cable	1PC rubber cable 1M H05RN-F 2 or 3x1mm square
Driver	Low voltage input constant current output for LED (High voltage item optional)

Construction Data

IP rating	IP67 Waterproof
IK rating	IK10
Housing	Solid Passivated (Anodizing) Aluminum CNC machined
Protection finishing	20~25µm thickness anodized film for housing. Dark grey
Trim	Stainless steel 316
Glass	/
Loading capacity	2000 kgs
Cable Gland	PG gland
Gasket	O-ring PMQ silicone seal

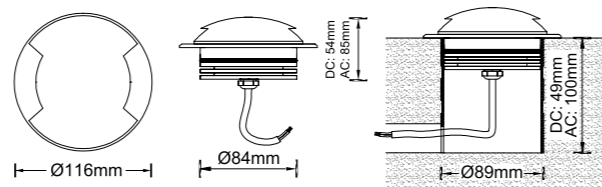
Accessories

Mounting Sleeve	Passivated (Anodizing) Aluminum CNC machined. Dark grey
-----------------	---

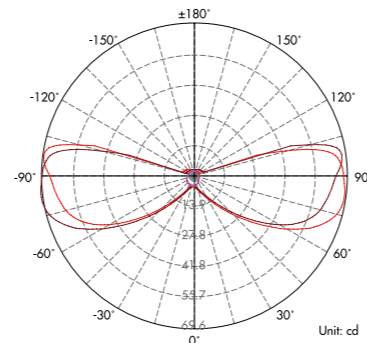
Packaging

Inner box size	105*105*140 mm
Carton size	55*23*30.5 cm (20 PCS / carton)

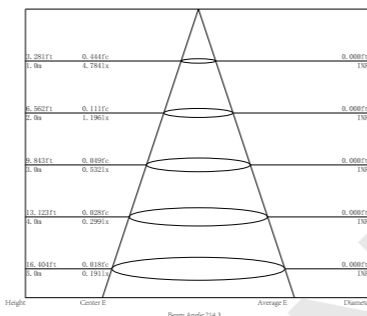
Dimension



Light Distribution Curve (3000K, 2x 60°*90°)



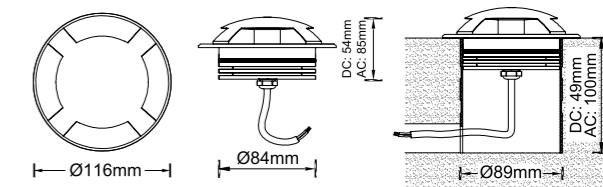
Lux distance Curve (3000K, 2x 60°*90°)



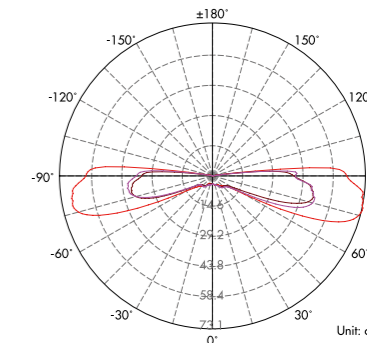
Illumination Picture (2x 60°*90°)



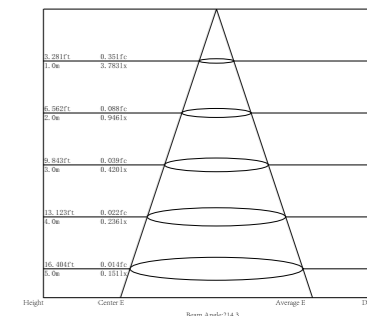
Dimension



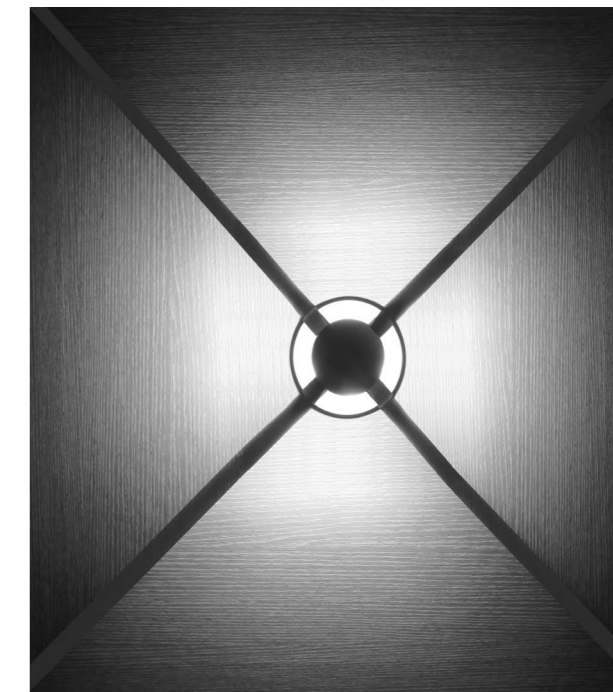
Light Distribution Curve (3000K, 4x 60°*90°)



Lux distance Curve (3000K, 4x 60°*90°)



Illumination Picture (4x 60°*90°)



CE RoHS COMPLIANT IP67 IK10

SSS 316 1 Year Warranty

Parameter

General Data

Item No.	DC24V version: UL-D004-0800-B AC100-264V version: UL-D004-0800-BH
Power	8 Watts +10%
LED type	4 PCS 2W OSAM 3030 SMD LED
Luminous flux	213lm +10%
CCT	2700K, 3000K, 4000K, 6000K, R/G/Y/B
CRI	80+
Beam angle	4x 60°*90°

Dimension DC version: Ø116x54 mm Diameter x Height
AC version: Ø116 x 85 mm Diameter x Height

Cut out	89 mm
Net weight	1 kgs
Warranty	1 year
Certifications	CE, RoHS

Electrical Data

Input voltage	DC24V (optional: AC100-265V)
Insulation class	Class III / Class I
Cable	1PC rubber cable 1M H05RN-F 2 or 3x1mm square
Driver	Low voltage input constant current output for LED (High voltage item optional)

Construction Data

IP rating	IP67 Waterproof
IK rating	IK10
Housing	Solid Passivated (Anodizing) Aluminum CNC machined
Protection finishing	20~25µm thickness anodized film for housing. Dark grey
Trim	Stainless steel 316
Glass	/
Loading capacity	2000 kgs
Cable Gland	PG gland
Gasket	O-ring PMQ silicone seal

Accessories

Mounting Sleeve	Passivated (Anodizing) Aluminum CNC machined. Dark grey
-----------------	---

Packaging

Inner box size	105*105*140 mm
Carton size	55*23*30.5 cm (20 PCS / carton)

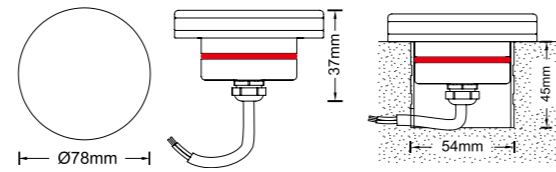


ILLUMINATING ASIA

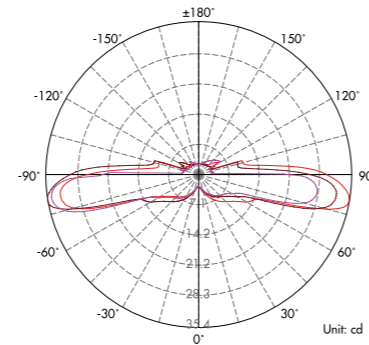




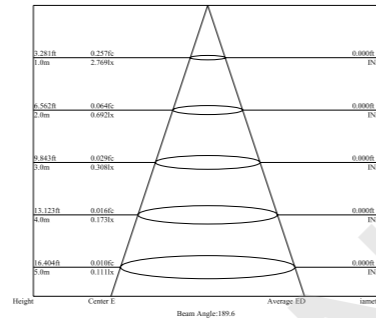
Dimension



Light Distribution Curve (3000K, 360°)



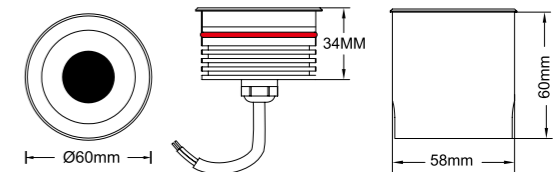
Lux distance Curve (3000K, 360°)



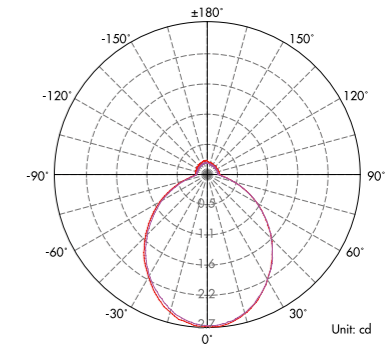
Illumination Picture (360°)



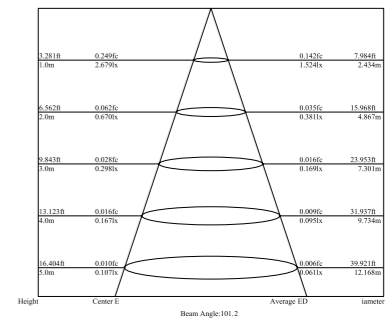
Dimension



Light Distribution Curve (Blue, 120°)



Lux distance Curve (Blue, 120°)



Illumination Picture (120°)



CE RoHS COMPLIANT IP67 IK10

SSS 316 Passivated 1 Year Warranty

Parameter

General Data	
Item No.	ULE001-0400-A /ULE001-0400-B
Power	4 Watts
LED type	18 PCS 2835 SMD LED
Luminous flux	140~150 lm
CCT	2700K, 3000K, 4000K, 6000K, R/G/Y/B
CRI	80+
Beam angle	360°
Dimension	78x37 (mm) Diameter x Height
Cut out	54 mm
Net weight	0.42 kgs
Warranty	1 year
Certifications	CE, RoHS
Electrical Data	
Input voltage	DC24V
Insulation class	Class III
Cable	1PC rubber cable 1M H05RN-F 2x1mm square
Driver	Low voltage constant current output, excluding the transformer
Construction Data	
IP rating	IP67 Waterproof
IK rating	IK10
Housing	Solid Passivated (Anodizing) Aluminum CNC machined
Protection finishing	20~25µm thickness anodized film for housing. Dark grey
Trim	Stainless steel 316
Glass	Without glass, but with PMMA diffuser
Loading capacity	>A: 100KGS; B: 500KGS for car driving over
Cable Gland	PG7 IP67
Gasket	O-ring PMQ silicone seal
Accessories	
Mounting Sleeve	Passivated (Anodizing) Aluminum CNC machined. Dark grey
Packaging	
Inner box size	85*85*85 mm
Carton size	45*19*19.5 cm (20PCS / carton)

CE RoHS COMPLIANT IP67 IK06

Passivated 1 Year Warranty

Parameter

General Data	
Item No.	ULE003-0300-A
Power	3 Watts
LED type	21 PCS 2835 SMD LED
Luminous flux	15~30 lm
CCT	2700K, 3000K, 4000K, 6000K, R/G/Y/B
CRI	80+
Beam angle	120°
Dimension	60x34 (mm) Diameter x Height
Cut out	58 mm
Net weight	0.24 kgs
Warranty	1 year
Certifications	CE, RoHS
Electrical Data	
Input voltage	DC12V /DC24V
Insulation class	Class III
Cable	1PC rubber cable 1M H05RN-F 2x1mm square
Driver	Low voltage constant current output, excluding the transformer
Construction Data	
IP rating	IP67 Waterproof
IK rating	IK06
Housing	Solid Passivated (Anodizing) Aluminum CNC machined
Protection finishing	20~25µm thickness anodized film for housing. Dark grey
Trim	Solid Passivated (Anodizing) Aluminum CNC machined. Black
Glass	Step tempered Glass. T=5.5mm.
Loading capacity	320 kgs
Cable Gland	PG7 IP67
Gasket	O-ring PMQ silicone seal
Accessories	
Mounting Sleeve	Anti-corrosion PVC. Grey
Packaging	
Inner box size	85*85*85 mm
Carton size	45*19*19.5 cm (20PCS / carton)

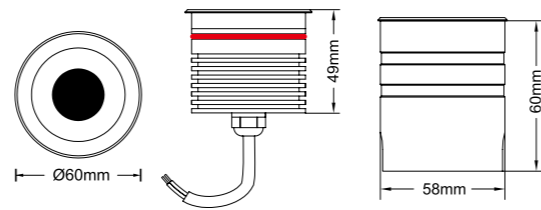


CE RoHS COMPLIANT IP67 IK06

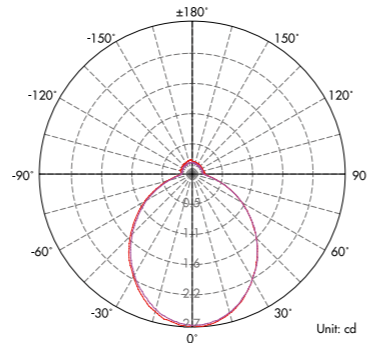
Passivated 1 Year Warranty

Parameter	
General Data	
Item No.	UL-E003-0300(RGB)-A
Power	3 Watts
LED type	6PCS 5050 3in1 RGB SMD LED
Luminous flux	90 lm (All LEDs on)
CCT	RGB
CRI	70+
Beam angle	120°
Dimension	60x49 (mm) Diameter x Height
Cut out	58 mm
Net weight	0.39 kgs
Warranty	1 year
Certifications	CE, RoHS
Electrical Data	
Input voltage	DC 12V /DC24V
Insulation class	Class III
Cable	1PC rubber cable 0.3M H05RN-F 4x0.5mm square
Driver	Low voltage constant current output, excluding the transformer
Construction Data	
IP rating	IP67 Waterproof
IK rating	IK06
Housing	Solid Passivated (Anodizing) Aluminum CNC machined
Protection finishing	20~25µm thickness anodized film for housing. Dark grey
Trim	Solid Passivated (Anodizing) Aluminum CNC machined
Glass	Step tempered Glass. T=5.5mm.
Loading capacity	320 kgs
Cable Gland	PG7 IP67
Gasket	O-ring PMQ silicone seal
Accessories	
Mounting Sleeve	Anti-corrosion PVC. Grey
Packaging	
Inner box size	100*70*80 mm
Carton size	37.5*22.5*26.5 cm (30PCS / carton)

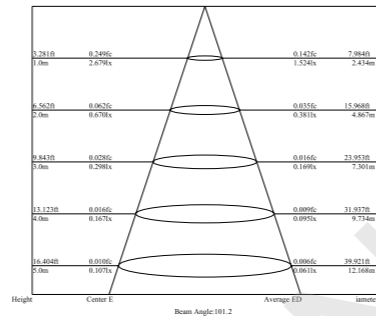
Dimension



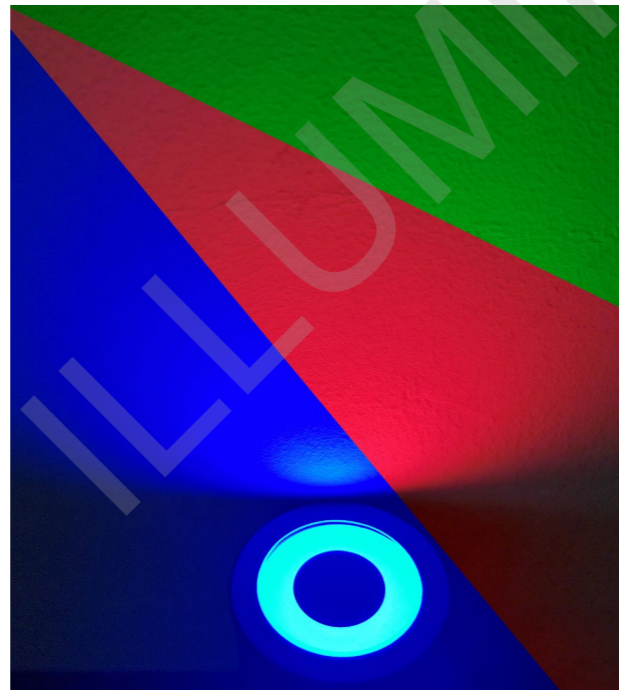
Light Distribution Curve (3000K, 360°)



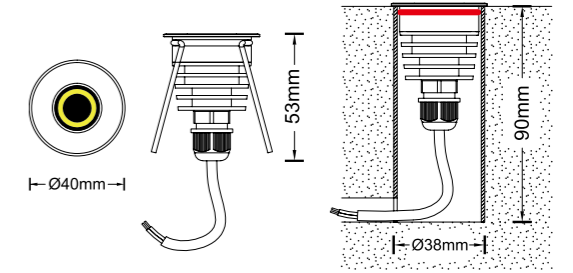
Lux distance Curve (3000K, 360°)



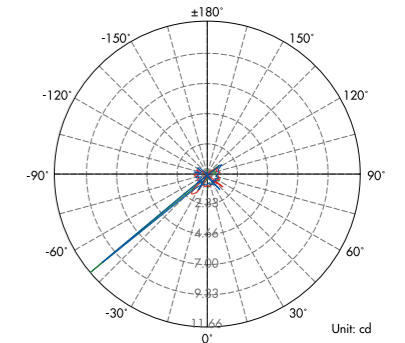
Illumination Picture (360°)



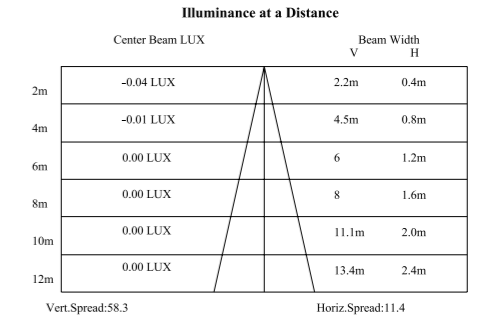
Dimension



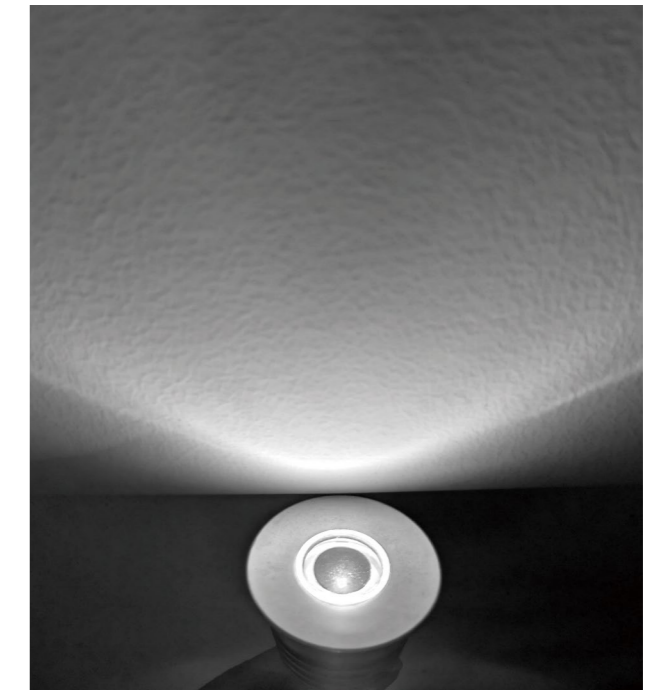
Light Distribution Curve (3000K, 120°)



Lux distance Curve (3000K, 120°)



Illumination Picture (120°)



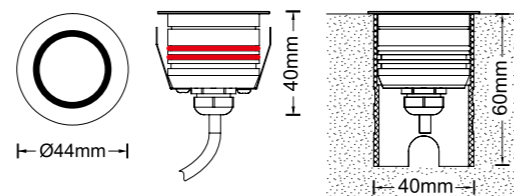
CE RoHS COMPLIANT IP67 IK06

SSS 316 Passivated 1 Year Warranty

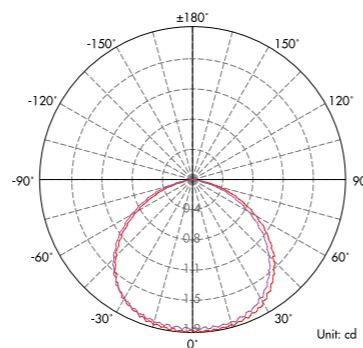
Parameter	
General Data	
Item No.	UL-1002-0300-A
Power	3 Watts
LED type	1 PC 3W CREE XPE LED
Luminous flux	95~100 lm
CCT	2700K, 3000K, 4000K, 6000K, R/G/Y/B
CRI	80+
Beam angle	120°
Dimension	40x53 (mm) Diameter x Height
Cut out	38 mm
Net weight	0.209 kgs
Warranty	1 year
Certifications	CE, RoHS
Electrical Data	
Input voltage	DC 12V~DC24V
Insulation class	Class III
Cable	1PC rubber cable 1M H05RN-F 2x1mm square
Driver	Low voltage constant current output, excluding the transformer
Construction Data	
IP rating	IP67 Waterproof
IK rating	IK06
Housing	Solid Passivated (Anodizing) Aluminum CNC machined
Protection finishing	20~25µm thickness anodized film for housing. Dark grey
Trim	Stainless steel 316
Glass	Step tempered Glass. T=4mm.
Loading capacity	320kgs
Cable Gland	PG7 IP67
Gasket	O-ring PMQ silicone seal
Accessories	
Mounting Sleeve	Passivated (Anodizing) Aluminum CNC machined. Dark grey
Clip	With Aluminium spring that's for deck lights or ceiling lights application
Packaging	
Inner box size	110*85*60 mm
Carton size	44*24*32 cm (50PCS / carton)



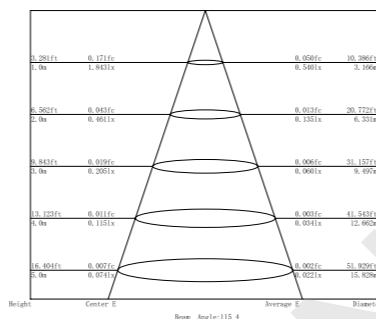
Dimension



Light Distribution Curve (3000K, 120°)



Lux distance Curve (3000K, 120°)



Illumination Picture (120°)



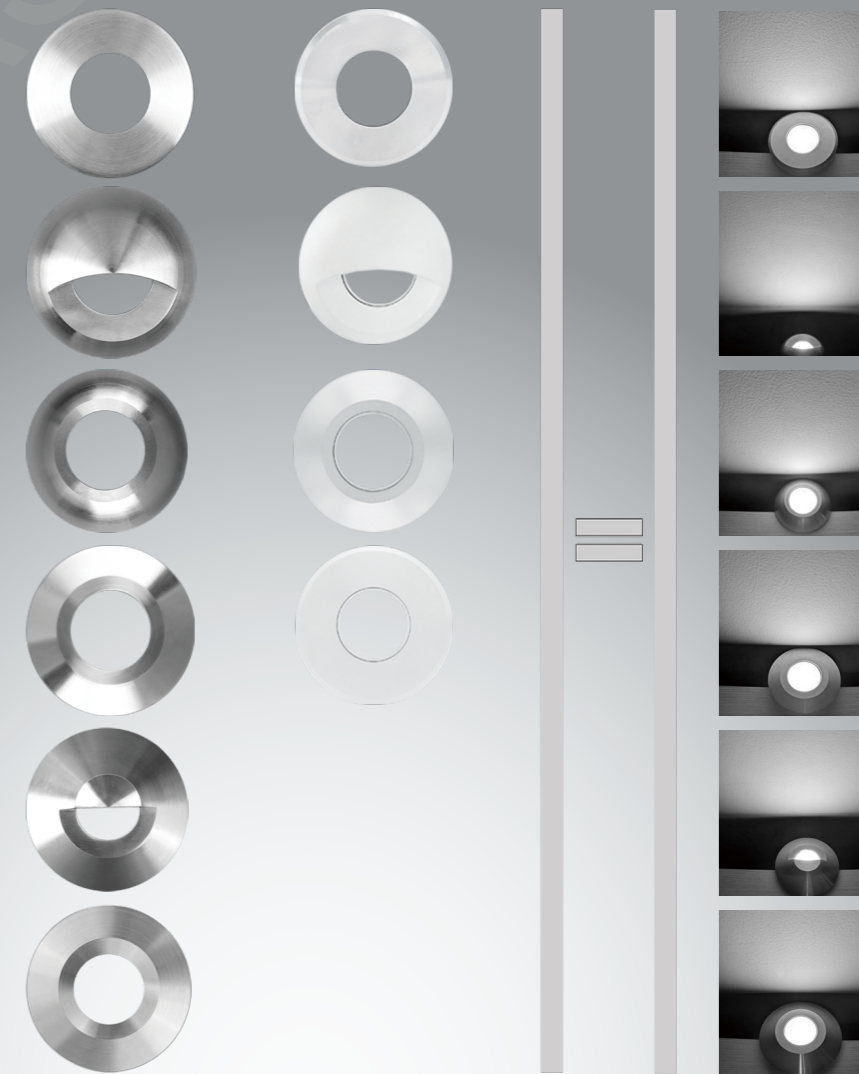
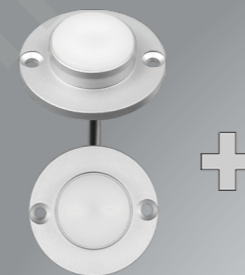
Surface mounted inground lights / deck lights / wall lights series

Personally customized!



Totally 10 kinds of covers compatible with one lamp body!
SS316 cover series Aluminium cover series

Lamp body



CE RoHS COMPLIANT IP67 IK07

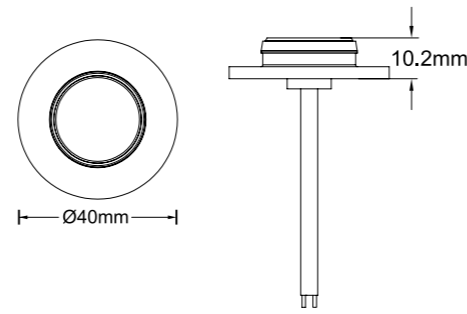
SSS 316 Passivated 1 Year Warranty

The icon / logo of the trim can be customized!

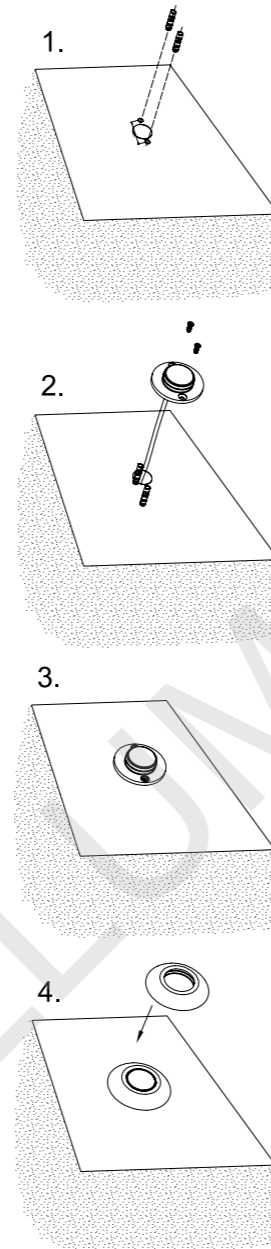
Parameter	
General Data	
Item No.	UL-E004-0200-A
Power	2 Watts +10%
LED type	1PC 2W OSRAM LED
Luminous flux	12lm +10%
CCT	2700K, 3000K, 4000K, 6000K, R/G/Y/B
CRI	80+
Beam angle	120°
Dimension	Ø44 x 40 (mm) Diameter x length
Cut out	40 mm
Net weight	0.23 kgs
Warranty	1 year
Certifications	CE, RoHS
Electrical Data	
Input voltage	DC24V
Insulation class	Class III
Cable	1PC rubber cable 0.3M H05RN-F 2 x 0.5mm square
Driver	Low voltage input constant current output
Construction Data	
IP rating	IP67 Waterproof
IK rating	IK07
Housing	Solid Passivated (Anodizing) Aluminum CNC machined
Protection finishing	20~25µm thickness anodized film for housing. silver color
Trim	Stainless steel 316 in white color or original 316 color The icon / logo of the trim can be customized
Glass	/
Loading capacity	500 kgs
Cable Gland	PG gland
Gasket	O-ring PMQ silicone seal
Accessories	
Mounting Sleeve	With mounting sleeve PVC as options used as inground light
Clip	With 2 clips as deck light or ceiling light
Packaging	
Inner box size	95*60*55mm
Carton size	40.5*32*30cm (100PCS / carton)



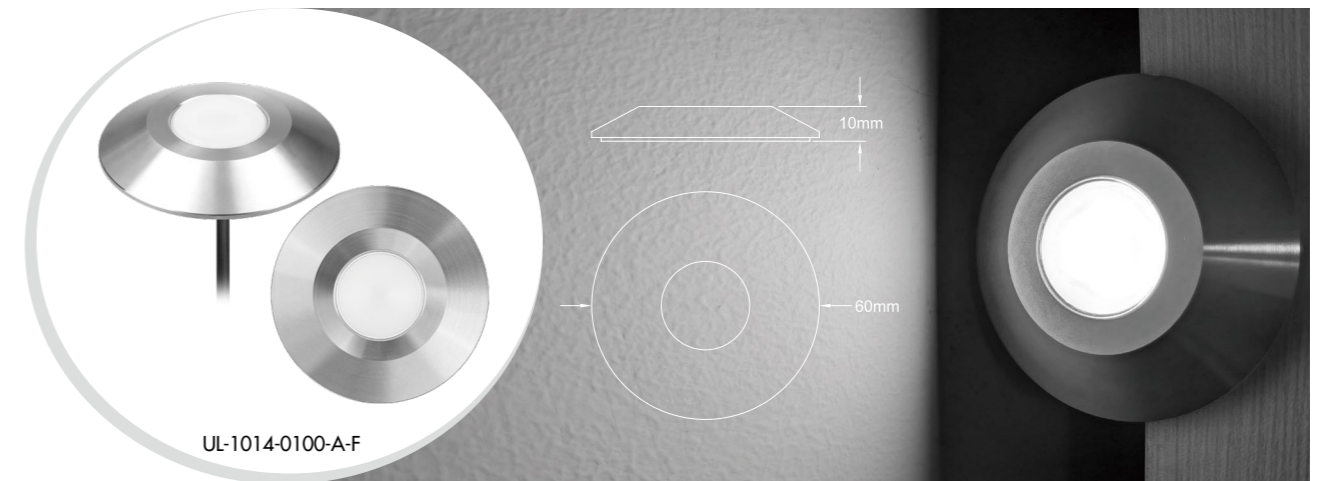
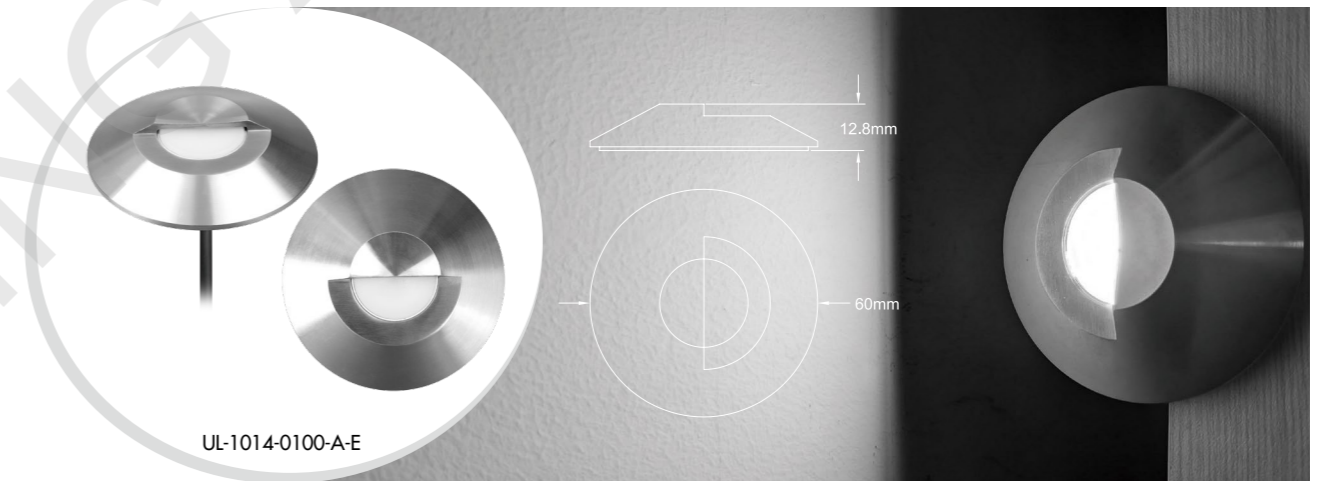
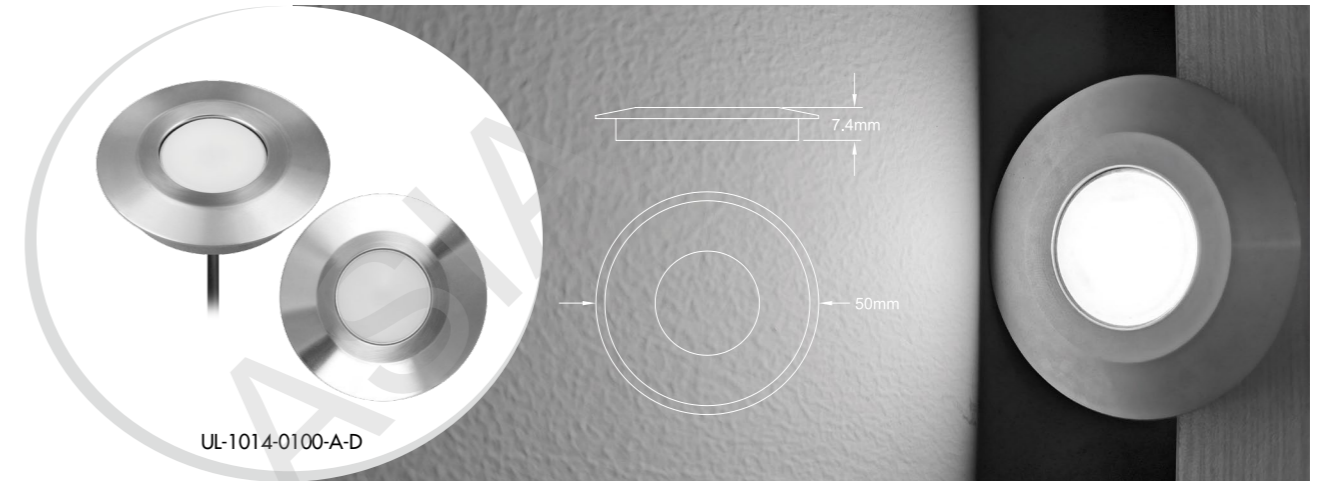
Dimension



Installation drawing for the lamp body item UL-1014 and the ten kinds cover in the next four pictures.



Stainless Steel 316 Covers Parts for UL-1014



General Data	UL-10140100-A-D	UL-10140100-A-E	UL-10140100-A-F
Item No.	UL-10140100-A-D	UL-10140100-A-E	UL-10140100-A-F
Material	Flat stainless steel 316	Step stainless steel 316	Cone stainless steel 316
Dimension	50x7.4 (mm) Diameter x Height	60x12.8 (mm) Diameter x Height	60x10 (mm) Diameter x Height
Net weight	52 g	99 g	96 g
Packing			
Inner box size	55*55*12 mm	65*65*17 mm	65*65*17 mm
Carton size	30*30*12 cm (200PCS / carton)	28.5*28.5*16 cm (90PCS / carton)	28.5*28.5*16 cm (90PCS / carton)

CE RoHS COMPLIANT IP67 IK06

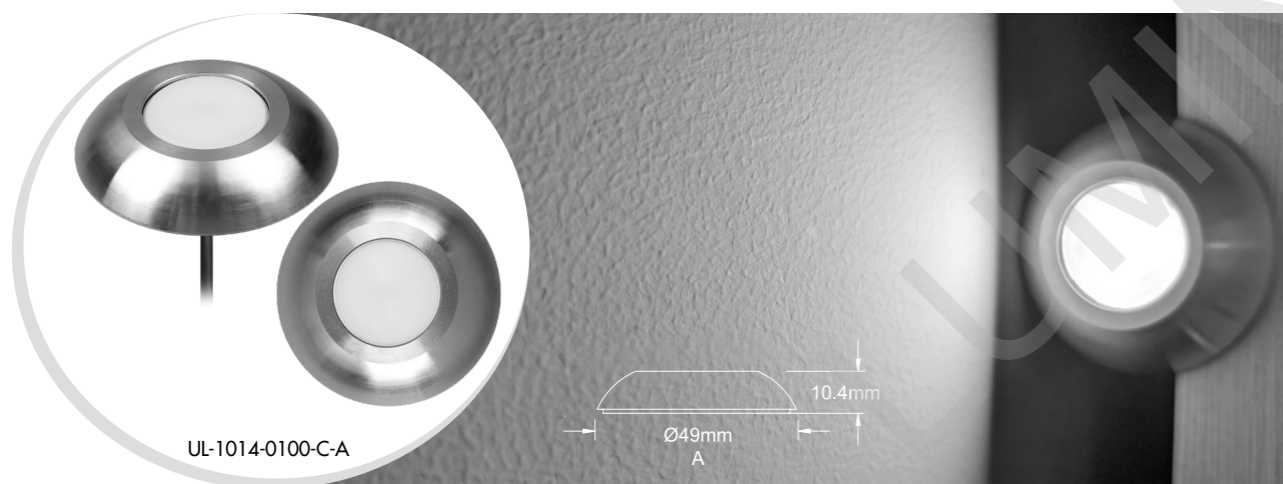
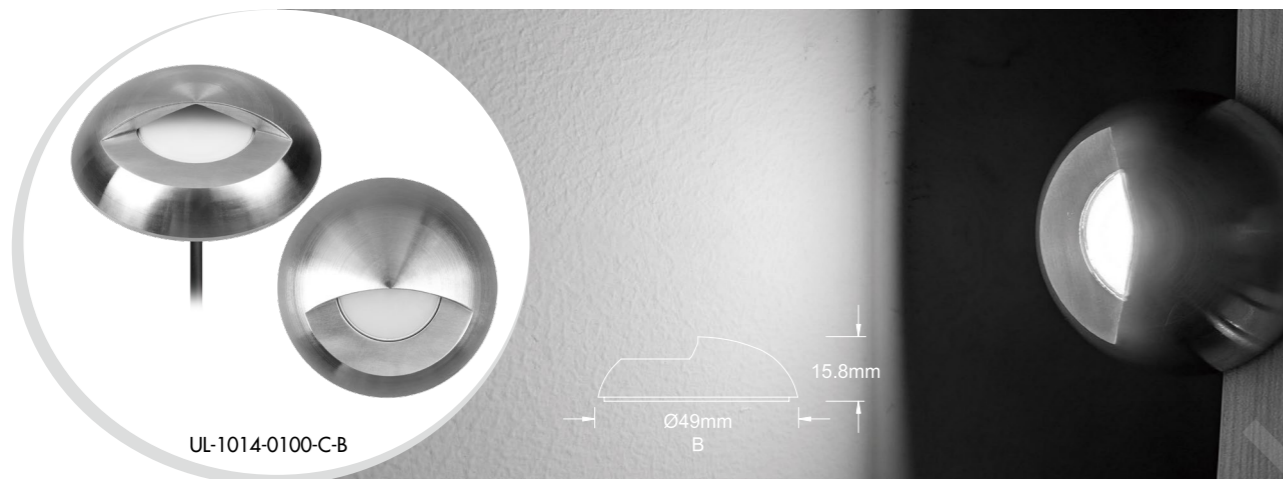
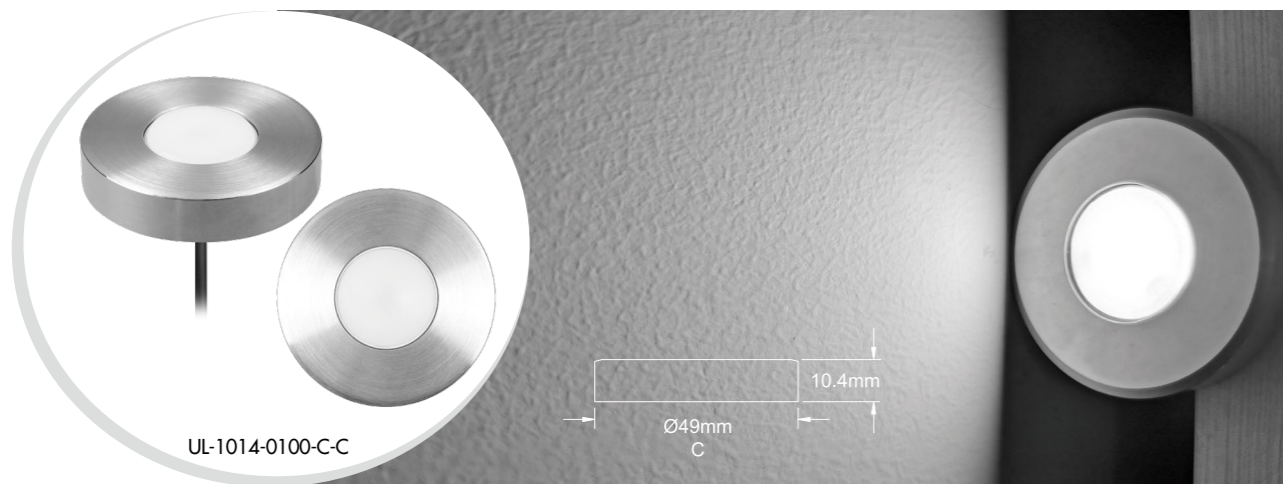
Passivated 1 Year Warranty

Compatible with ten kinds of covers!

Parameter

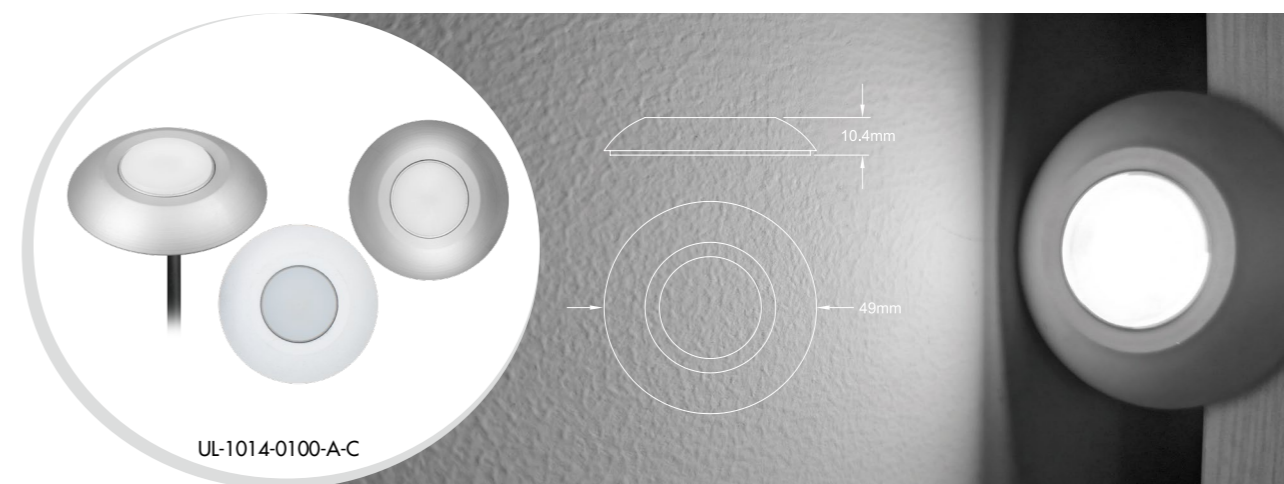
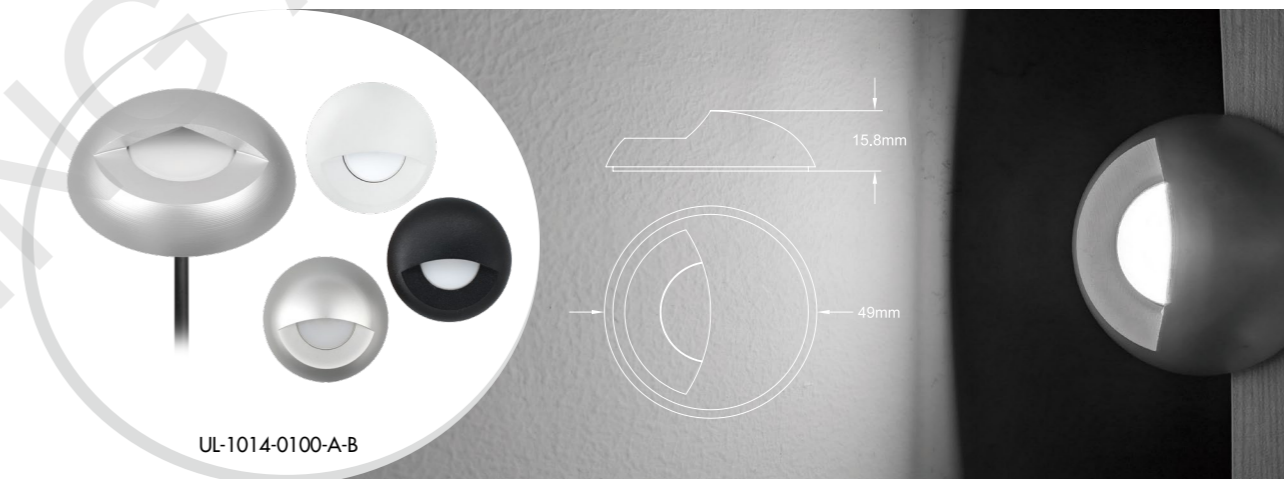
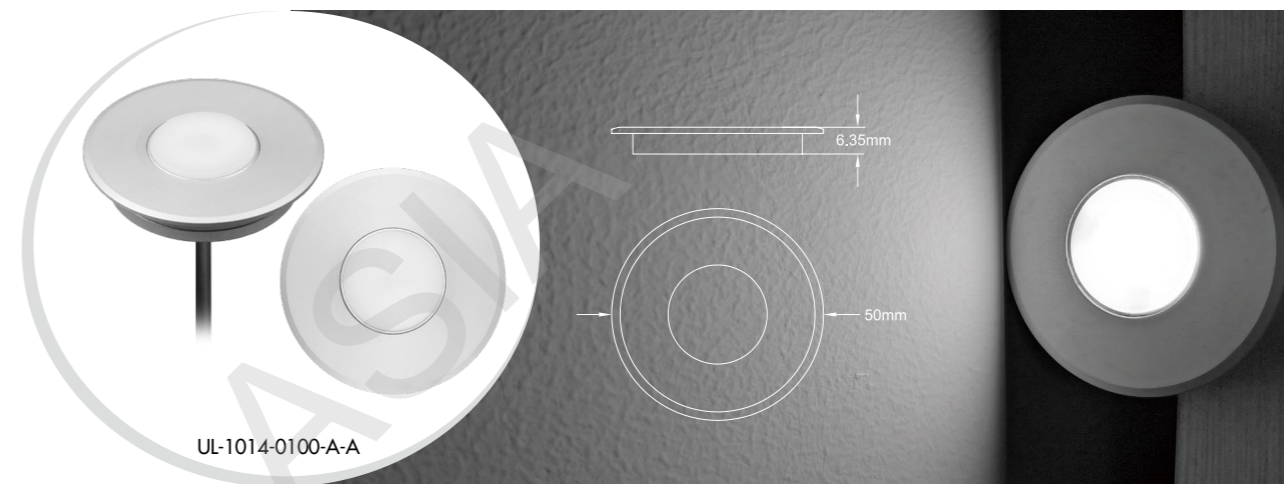
General Data	
Item No.	UL-1014-0200-C
Power	1.2 Watts
LED type	1PC 1W OSRAM LED
Luminous flux	80~85 lm
CCT	2700K, 3000K, 4000K, 6000K, R,G,B
CRI	80+
Beam angle	120°
Dimension	40x10.2 (mm) Diameter x Height
Cut out	/
Net weight	0.073kgs
Warranty	1 year
Certifications	CE, RoHS
Electrical Data	
Input voltage	DC 12V /DC24V
Insulation class	Class III
Cable	1PC PVC cable 0.3M 2x0.34 mm square
Driver	Low voltage constant current output, excluding the transformer
Construction Data	
IP rating	IP67 Waterproof
IK rating	IK06
Housing	Solid Passivated (Anodizing) Aluminum CNC machined
Protection finishing	20~25µm thickness anodized film for housing. Dark grey or grey
Trim	Ten kinds of covers as options (in the next four pages)
Glass	Without glass, but with PMMA diffuser
Loading capacity	320 kgs
Cable Gland	Aluminium part IP67
Gasket	O-ring PMQ silicone seal
Accessories	
Mounting Sleeve	Without sleeve, but with screws for easy surface mounting.
Packaging	
Inner box size	95*60*55 mm
Carton size	40.5*32*30 cm (100PCS / carton)

Stainless Steel 316 Covers Parts for UL-1014

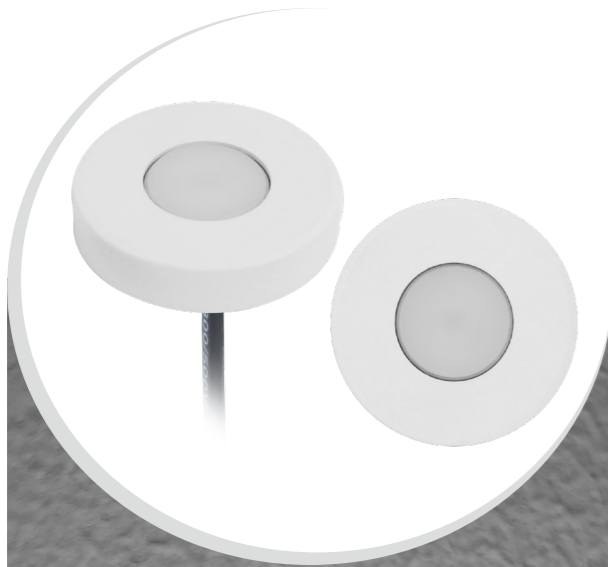


General Data			
Item No.	UL-1014-0100-CC	UL-1014-0100-CB	UL-1014-0100-CA
Material	Flush stainless steel 316 cover	Eyelid stainless steel 316 6063 cover	Dome stainless steel 316 6063 cover
Dimension	49 x 10.4 (mm) Diameter x Height	49 x 15.8 (mm) Diameter x Height	49 x 10.4 (mm) Diameter x Height
Net weight	83 g	78 g	56 g
Packing			
Inner box size	55*55*12 mm	65*65*17 mm	65*65*17 mm
Carton size	30*30*12 cm (200PCS / carton)	28.5*28.5*16 cm (90PCS / carton)	28.5*28.5*16 cm (90PCS / carton)

Passivated (Anodizing) Aluminium Covers Parts for UL-1014

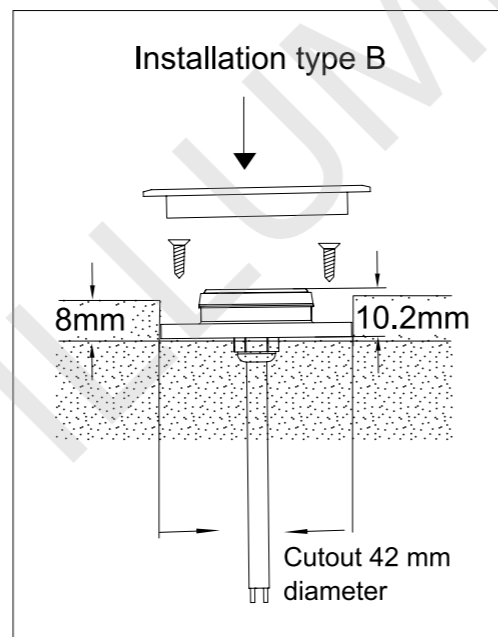
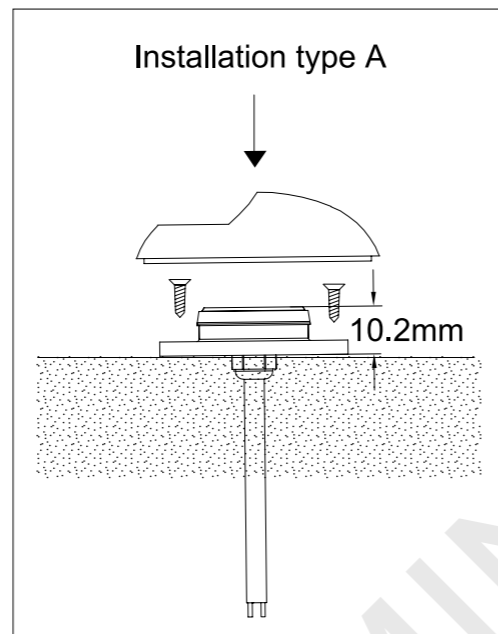


General Data			
Item No.	UL-1014-0100-AA	UL-1014-0100-AB	UL-1014-0100-AC
Material	Flush anodized aluminium 6063	Eyelid anodized aluminium 6063	Dome anodized aluminium 6063
Dimension	50x6.35 (mm) Diameter x Height	49x15.8 (mm) Diameter x Height	49x10.4 (mm) Diameter x Height
Net weight	16 g	24 g	17 g
Packing			
Inner box size	65*65*17 mm	55*55*12 mm	55*55*12 mm
Carton size	28.5*28.5*16 cm (90PCS / carton)	30*30*12 cm (200PCS / carton)	30*30*12 cm (200PCS / carton)



Parameter	
General Data	
Item No.	UL-1014-0100-AG
Material	Flush anodized aluminium 6063 cover in silver color or powder painted in white color or black color
Dimension	49 x 10.4 (mm) Diameter x Height
Packaging	
Inner box size	55*55*12 mm
Carton size	30*30*12 cm (200PCS / carton)

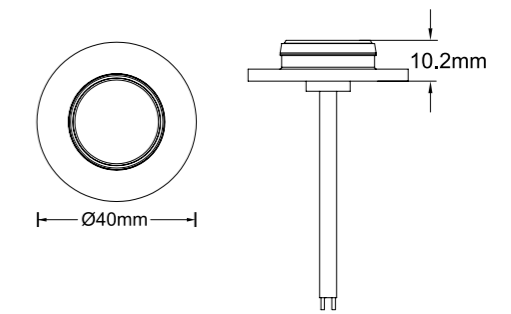
Installation for the covers



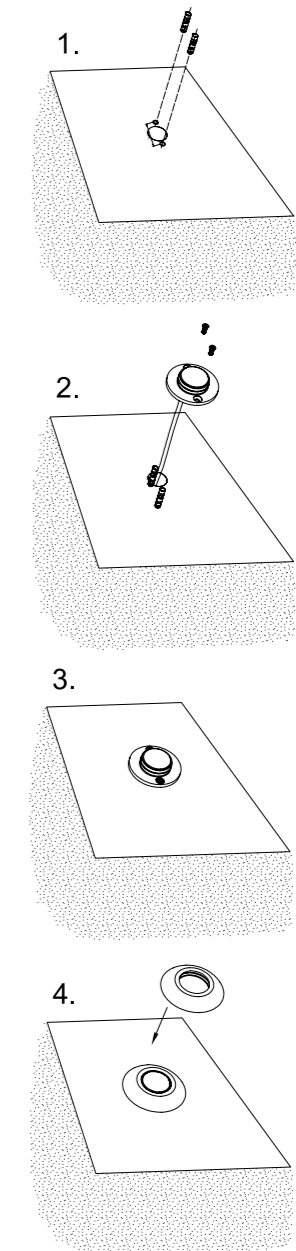
IP67 IK06
Passivated 1 Year Warranty
Compatible with ten kinds of covers!

Parameter	
General Data	
Item No.	UL-1014-0200 (RGB)B
Power	1.2 Watts
LED type	1 PC 3in1 RGB Epistar LED
Luminous flux	60 lm (all LEDs on)
CCT	RGB
CRI	70+
Beam angle	120°
Dimension	40x10.2 (mm) Diameter x Height
Cut out	/
Net weight	0.12 kgs
Warranty	1 year
Certifications	CE, RoHS
Electrical Data	
Input voltage	DC 12V/DC24V
Insulation class	Class III
Cable	1PC 0.3M PVC cable 4 x 0.3mm square
Driver	Low voltage constant current output, excluding the transformer
Construction Data	
IP rating	IP67 Waterproof
IK rating	IK06
Housing	Solid Passivated (Anodizing) Aluminum CNC machined
Protection finishing	20~25µm thickness anodized film for housing. Dark grey or grey
Trim	Nine kinds of covers as options (in the before two pages)
Glass	/
Loading capacity	320 kgs
Cable Gland	Aluminium part IP67
Gasket	O-ring PMQ silicone seal
Accessories	
Mounting Sleeve	Without sleeve, but with screws for easy surface mounting.
Packaging	
Inner box size	38*38*20 mm
Carton size	25*25*18.5 cm (100PCS / carton)

Dimension



Installation Drawing (It's compatible with the six kinds of cover in the before two pages!)





The laser logo or icon in the middle with light output can be customized with client's company logo or any icons!
The MOQ is only 10PCS for customizing!

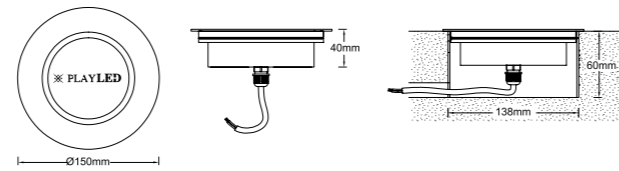
CE RoHS COMPLIANT IP67 IK06

Passivated 1 Year Warranty

Parameter

General Data	
Item No.	UL-6005-0600A (LOGO)
Power	6 Watts
LED type	3 PCS OSRAM LED
Luminous flux	10-12 lm
CCT	2700K, 3000K, 4000K, 6000K
CRI	80+
Beam angle	120°
Dimension	150 x 40 (mm) Diameter x Height
Cut out	138 mm
Net weight	0.35 kgs
Warranty	1 year
Certifications	CE, RoHS
Electrical Data	
Input voltage	DC24V
Insulation class	Class III
Cable	1PC rubber cable 1M H05RN-F 2x1mm square
Driver	low voltage constant current output, excluding the transformer
Construction Data	
IP rating	IP67 Waterproof
IK rating	IK06
Housing	Solid Passivated (Anodizing) Aluminum CNC machined
Protection finishing	20-25µm thickness anodized film for housing, silver color
Trim	Stainless steel 316
Glass	Tempered Glass, T=6mm.
Loading capacity	320 kgs
Cable Gland	PG7 IP67
Gasket	O-ring PMQ silicone seal
Accessories	
Mounting Sleeve	Anti-corrosion grey PVC
Clip	2 pcs SS304 spring with screws as options
Packaging	
Inner box size	160*160*80 mm
Carton size	34.5*34.5*26.5 cm (12PCS / carton)

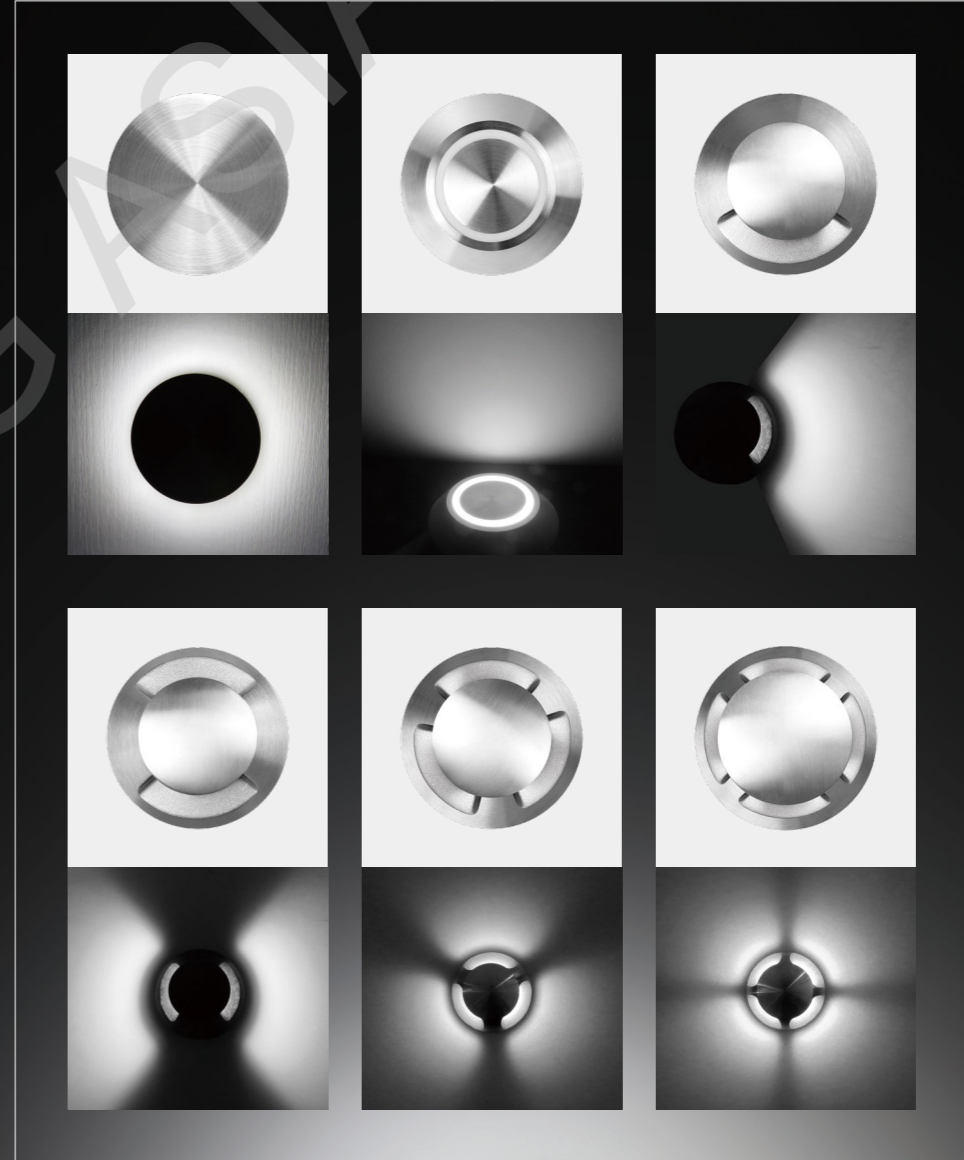
Dimension

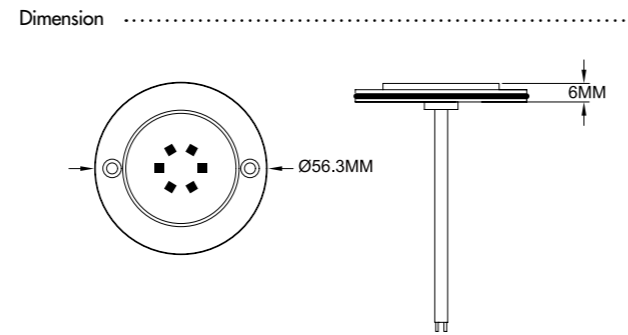


Light Distribution Curve (3000K, 120°)

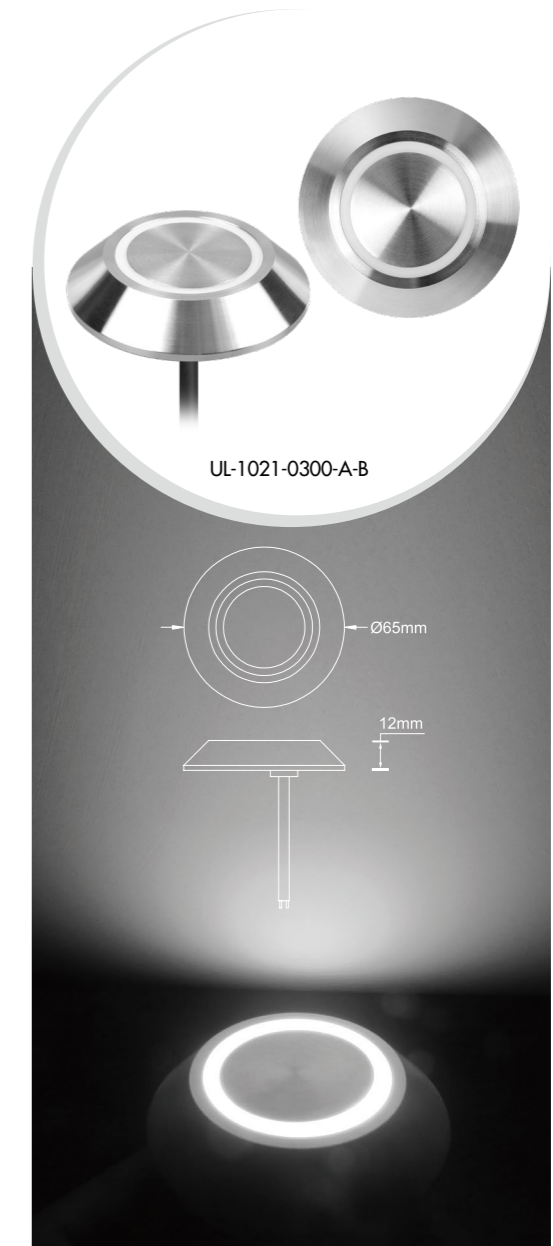
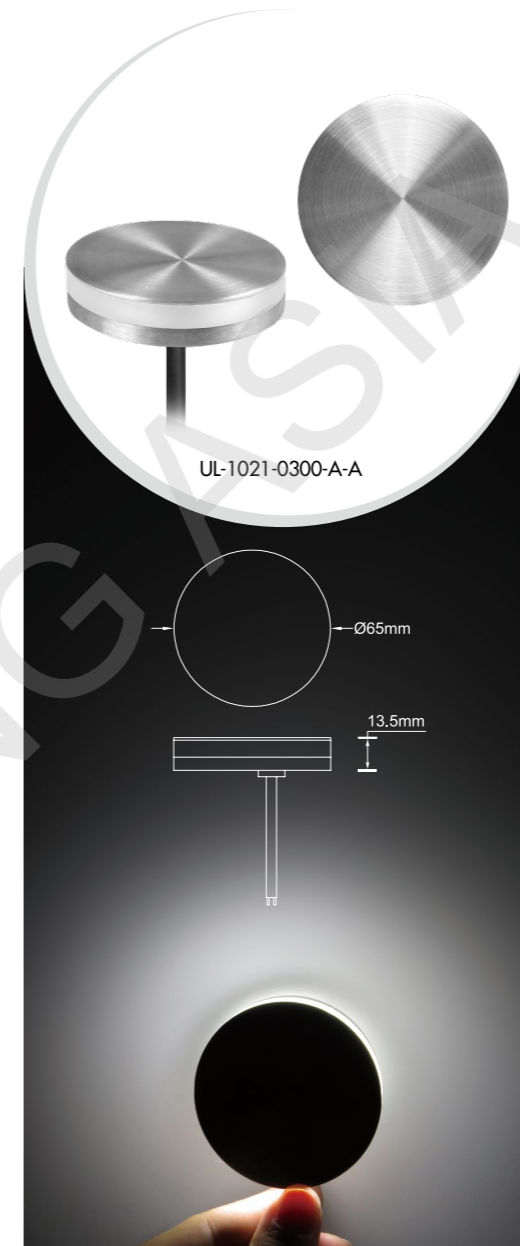
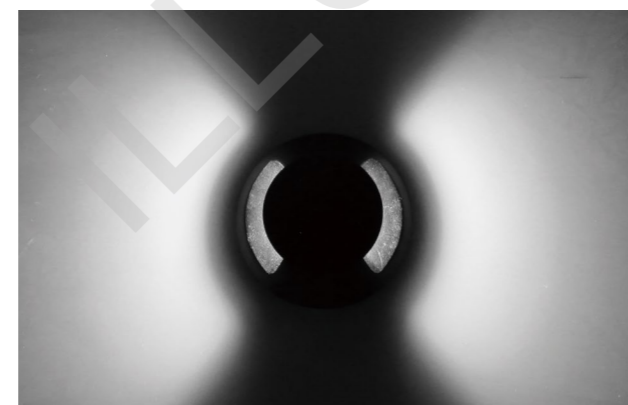
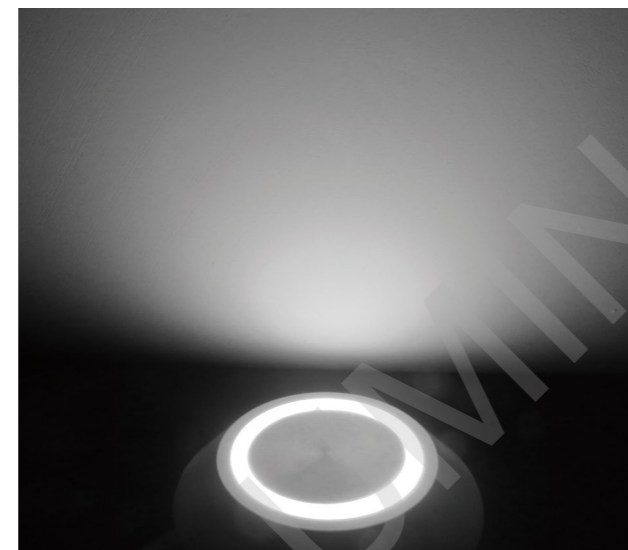
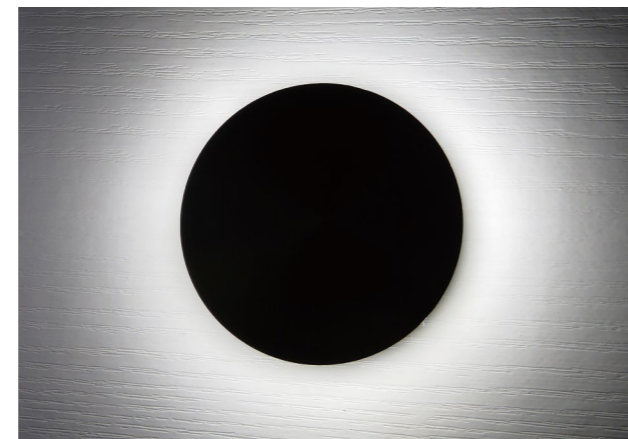
Lux distance Curve (3000K, 120°)

Illumination Picture (120°)





The six kinds of covers in the next three pages for this lamp body UL-1021-0300-A.



General Data		
Item No.	UL-1021-0300-A-A	UL-1021-0300-A-B
Material	Stainless steel 316+PMWA	Stainless steel 316+PMWA
Dimension	65 x 13.5 (mm) Diameter x Height	65x 12 (mm) Diameter x Height
Net weight	63g	83g
Packing		
Inner box size	70*70*20 mm	70*70*20 mm
Carton size	37.5*37.5*12.5 cm (150PCS / carton)	37.5*37.5*12.5 cm (150PCS / carton)

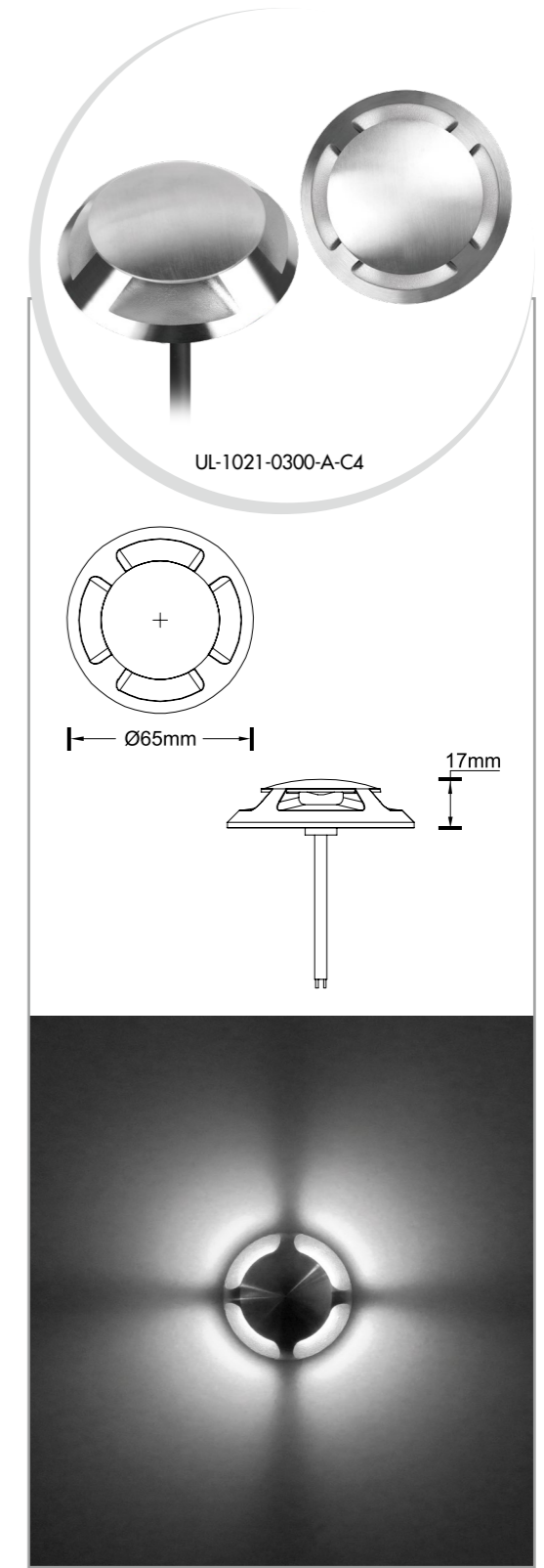
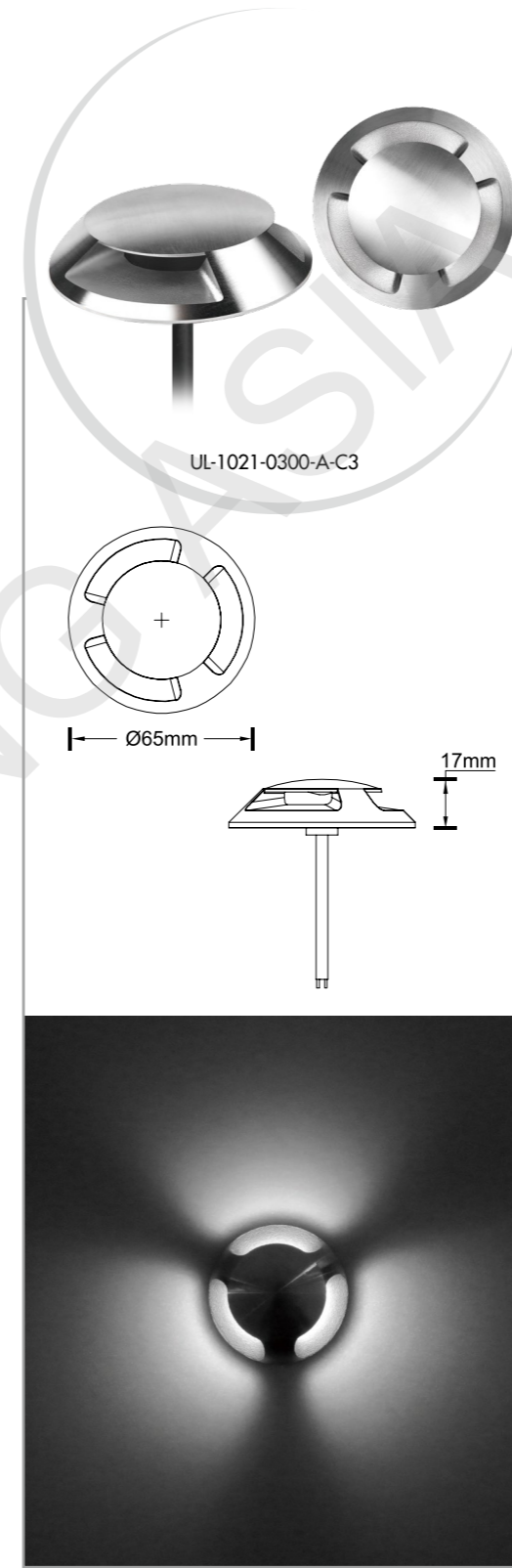
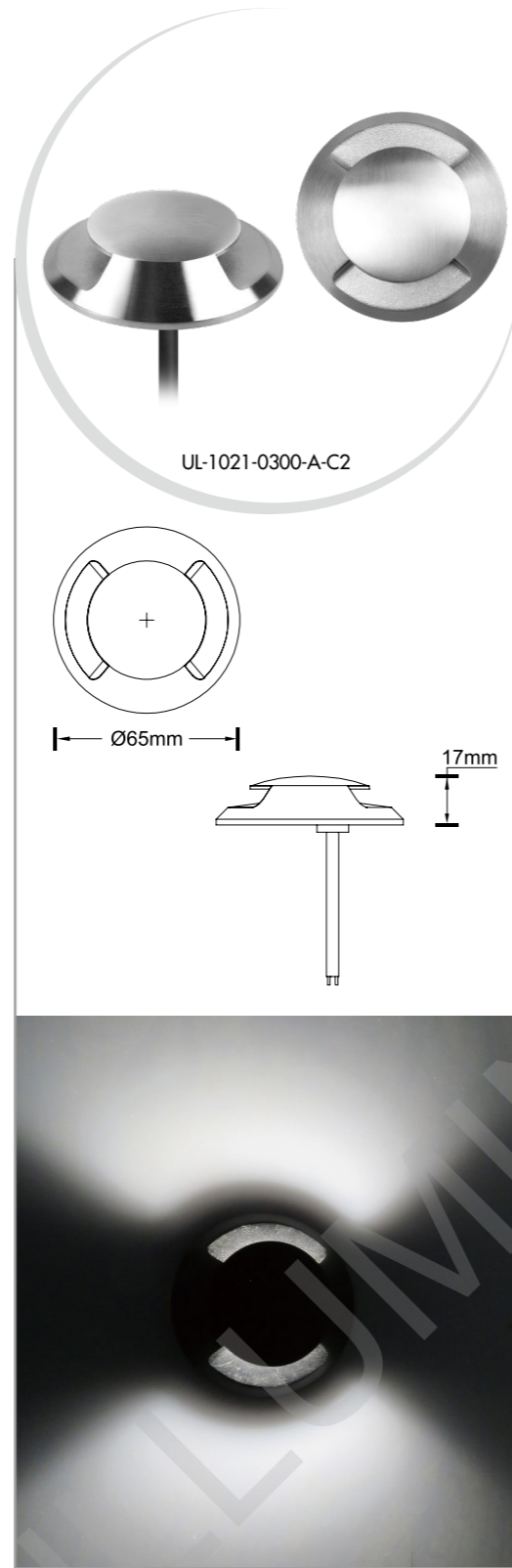
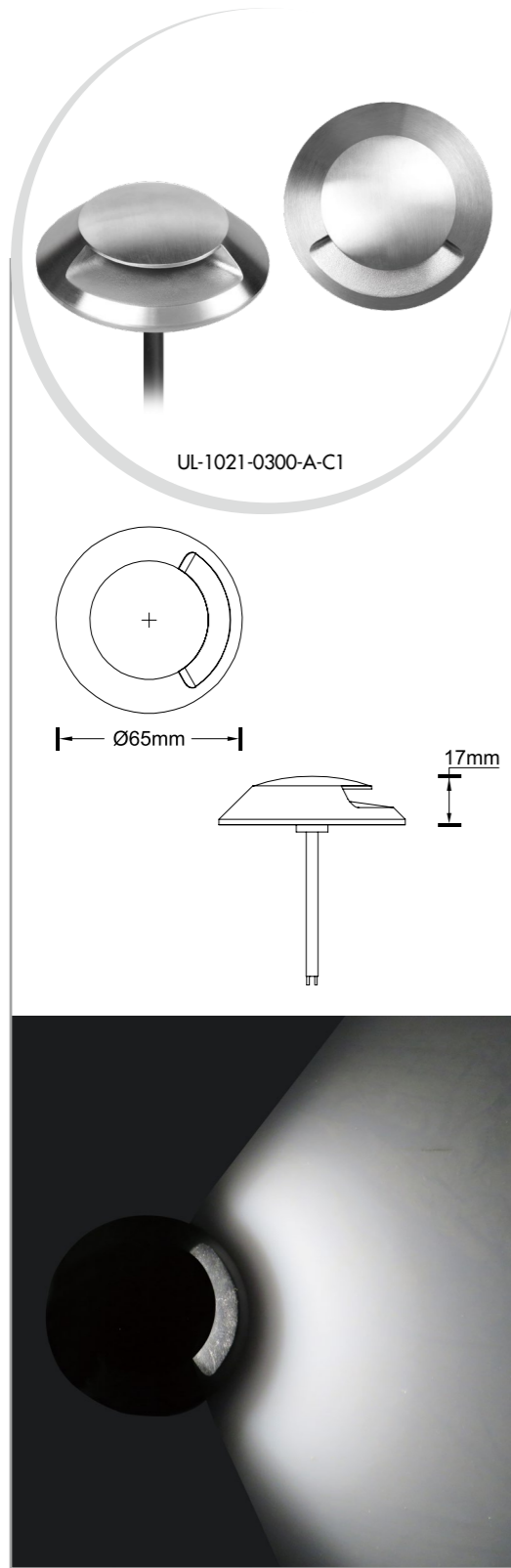
CE RoHS COMPLIANT IP67 IK10

Passivated 1 Year Warranty

Compatible with six kinds of covers

Parameter	
General Data	
Item No.	UL-1021-0300-A/UL-1021-0300(RGB)/A/UL-1021-0300(RGBW)/A
Power	3 Watts
LED type	6PCS 1W OSRAM LED / 3PCS 5050RGB LED / 3PCS RGBW6000K LED
Luminous flux	Lamp:240lm / A cover:24lm / B cover:10lm / C1 cover:5lm / C2 cover:5lm / C3 cover:5lm / C4 cover: 5lm
CCT	2700K, 3000K, 4000K, 6000K, R,G,B or RGB or RGBW6000K
CRI	80+
Beam angle	120°
Dimension	56.3x 6 (mm) Diameter x Height
Cut out	/
Net weight	0.032kgs
Warranty	1 year
Certifications	CE, RoHS
Electrical Data	
Input voltage	DC24V (or DC12V) for single color, DC12V for RGB,RGBW
Insulation class	Class III
Cable	1 PC cable 0.3M 2 or 4 or 5 x 0.35 mm square
Driver	Low voltage constant current output, excluding the transformer
Construction Data	
IP rating	IP67 Waterproof
IK rating	IK10 with cover
Housing	Solid Passivated (Anodizing) Aluminum CNC machined
Protection finishing	20~25µm thickness anodized film for housing
Trim	Six kinds of covers as options (in the next three pages)
Glass	Without glass, but with glue
Loading capacity	320 kgs
Cable Gland	Aluminium part
Gasket	O-ring PMQ silicone seal
Accessories	
Mounting Sleeve	Without sleeve, but with screws for easy surface mounting.
Packaging	
Inner box size	65*65*30 mm
Carton size	35*35*20.5 cm (150PCS / carton)





General Data		
Item No.	UL-1021-0300-A-C1	UL-1021-0300-A-C2
Material	Stainless steel 316+PMMA	Stainless steel 316+PMMA
Dimension	65 x 17 (mm) Diameter x Height	65x 17(mm) Diameter x Height
Net weight	118g	109g
Packing		
Inner box size	70*70*20 mm	70*70*20 mm
Carton size	37.5*37.5*12.5 cm (150PCS / carton)	37.5*37.5*12.5 cm (150PCS / carton)

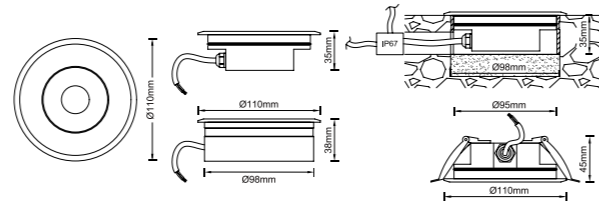
General Data		
Item No.	UL-1021-0300-A-C3	UL-1021-0300-A-C4
Material	Stainless steel 316+PMMA	Stainless steel 316+PMMA
Dimension	65 x 17 (mm) Diameter x Height	65x 17(mm) Diameter x Height
Net weight	110g	107g
Packing		
Inner box size	70*70*20 mm	70*70*20 mm
Carton size	37.5*37.5*12.5 cm (150PCS / carton)	37.5*37.5*12.5 cm (150PCS / carton)



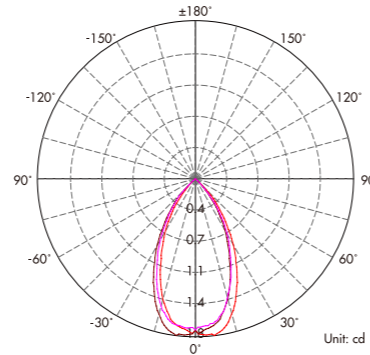
Panda Micro



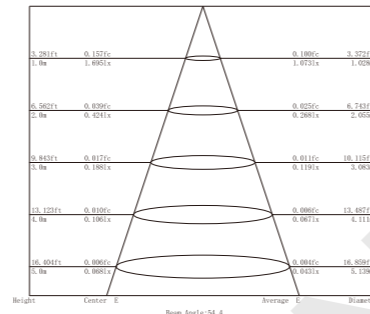
Dimension



Light Distribution Curve (3000K, 50°)



Lux distance Curve (3000K, 50°)



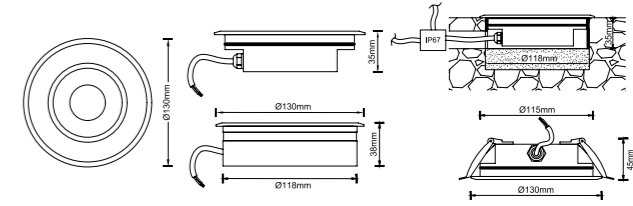
Illumination Picture (50°)



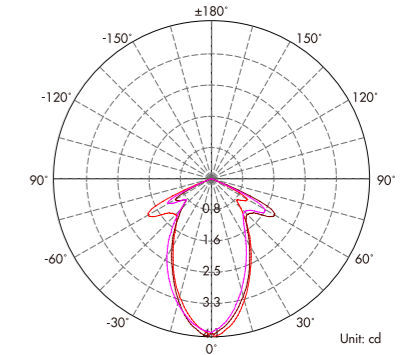
Panda Mini



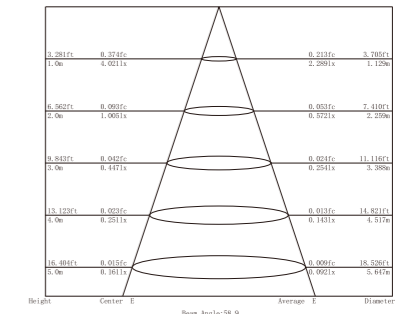
Dimension



Light Distribution Curve (3000K, 60°)



Lux distance Curve (3000K, 60°)



Illumination Picture (60°)



CE RoHS COMPLIANT IP67 IK08

SSS 316 Patent 1 Year Warranty
Used as inground lights, deck lights!

Parameter

General Data	
Item No.	UL-3W-FX-03001
Power	2.6 Watts +10%
LED type	6 PCS LUMILEDS 2835 SMD LED
Luminous flux	/
CCT	2700K, 3000K, 4000K, 5700K, 6500K
CRI	80+
Beam angle	50°
Dimension	Ø110x35 (mm) Diameter x length
Cut out	Ø98 mm with sleeve, Ø95mm with clip
Net weight	0.55 kgs
Warranty	1 year
Certifications	CE, RoHS
Electrical Data	
Input voltage	DC24V
Insulation class	Class III
Cable	1PC rubber cable 1M H05RN-F 2x1mm square
Driver	Low constant voltage input driver, constant current output for LEDs
Construction Data	
IP rating	IP67 Waterproof
IK rating	IK08
Housing	Solid Passivated (Anodizing) Aluminum CNC machined
Protection finishing	20~25µm thickness anodized film for housing .Dark grey
Trim	Stainless steel 316
Glass	Step tempered Glass.T=8mm.
Loading capacity	500 kgs
Cable Gland	PG gland
Gasket	O-ring PMQ silicone seal
Accessories	
Mounting Sleeve	Passivated (Anodizing) Aluminum CNC machined .Dark grey
Clip	With spring as options, that's for wall lights, deck lights application
Packaging	
Inner box size	120*120*60 mm
Carton size	38.5*26.5*20.5 cm (18 PCS / carton)

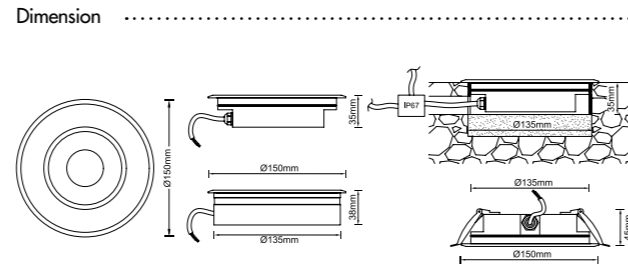
CE RoHS COMPLIANT IP67 IK08

SSS 316 Patent 1 Year Warranty
Used as inground lights, deck lights!

Parameter

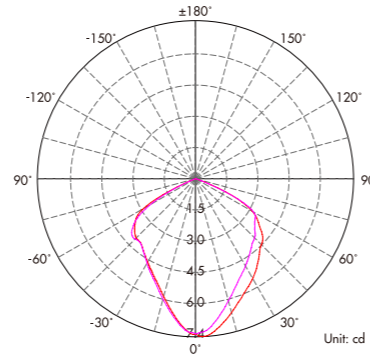
General Data	
Item No.	UL-6W-FX-06001
Power	6 Watts +10%
LED type	9 PCS LUMILEDS 2835 SMD LED
Luminous flux	/
CCT	2700K, 3000K, 4000K, 5700K, 6500K
CRI	80+
Beam angle	60°
Dimension	Ø130x35 (mm) Diameter x length
Cut out	Ø118 mm with sleeve, Ø115mm with clip
Net weight	0.75 kgs
Warranty	1 year
Certifications	CE, RoHS
Electrical Data	
Input voltage	DC24V
Insulation class	Class III
Cable	1PC rubber cable 1M H05RN-F 2x1mm square
Driver	Low constant voltage input driver, constant current output for LEDs
Construction Data	
IP rating	IP67 Waterproof
IK rating	IK08
Housing	Solid Passivated (Anodizing) Aluminum CNC machined
Protection finishing	20~25µm thickness anodized film for housing .Dark grey
Trim	Stainless steel 316
Glass	Step tempered Glass.T=8mm.
Loading capacity	500 kgs
Cable Gland	PG gland
Gasket	O-ring PMQ silicone seal
Accessories	
Mounting Sleeve	Passivated (Anodizing) Aluminum CNC machined .Dark grey
Clip	With spring as options, that's for wall lights, deck lights application
Packaging	
Inner box size	140*140*60 mm
Carton size	30.5*30.5*20.5 cm (12 PCS / carton)

Panda Midi

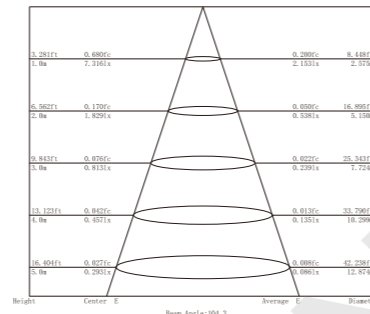


Dimension

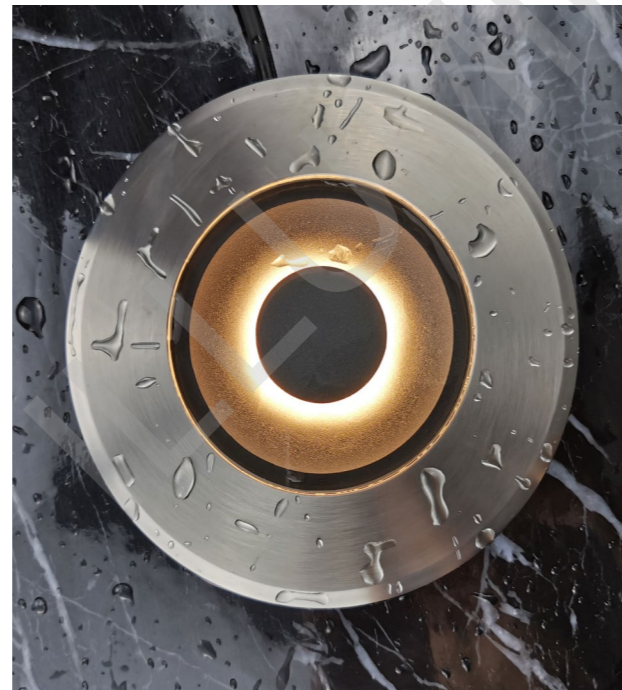
Light Distribution Curve (3000K, 100°)



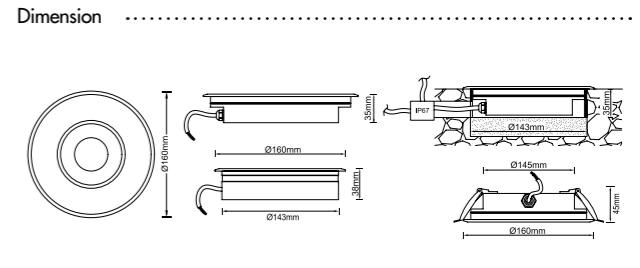
Lux distance Curve (3000K, 100°)



Illumination Picture (100°)

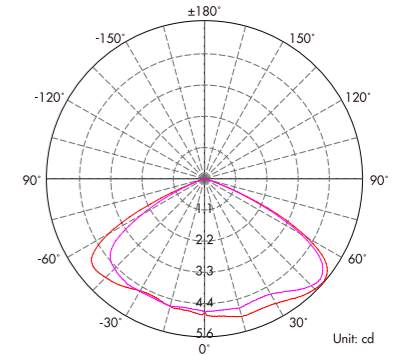


Panda Maxi

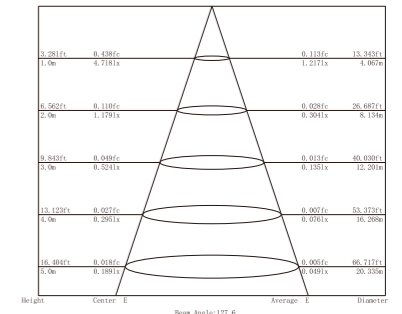


Dimension

Light Distribution Curve (3000K, 130°)



Lux distance Curve (3000K, 130°)



Illumination Picture (130°)



CE RoHS COMPLIANT IP67 IK08

SSS 316 Patent 1 Year Warranty

Used as inground lights, deck lights !

Parameter

General Data	
Item No.	UL-9W-FX-09001
Power	9 Watts +10%
LED type	12 PCS LUMILEDS 2835 SMD LED
Luminous flux	/
CCT	2700K, 3000K, 4000K, 5700K, 6500K
CRI	80+
Beam angle	100°
Dimension	Ø150x35 (mm) Diameter x length
Cut out	Ø135 mm with sleeve, Ø135mm with clip
Net weight	0.98 kgs
Warranty	1 year
Certifications	CE, RoHS
Electrical Data	
Input voltage	DC24V
Insulation class	Class III
Cable	1PC rubber cable 1M H05RN-F 2x1mm square
Driver	Low constant voltage input driver, constant current output for LEDs
Construction Data	
IP rating	IP67 Waterproof
IK rating	IK08
Housing	Solid Passivated (Anodizing) Aluminum CNC machined
Protection finishing	20~25µm thickness anodized film for housing .Dark grey
Trim	Stainless steel 316
Glass	Step tempered Glass.T=8mm.
Loading capacity	500 kgs
Cable Gland	PG gland
Gasket	O-ring PMQ silicone seal
Accessories	
Mounting Sleeve	Passivated (Anodizing) Aluminum CNC machined .Dark grey
Clip	With spring as options, that's for wall lights, deck lights application
Packaging	
Inner box size	160*160*60 mm
Carton size	34.5*34.5*20.5 cm (12 PCS / carton)

CE RoHS COMPLIANT IP67 IK08

SSS 316 Patent 1 Year Warranty

Used as inground lights, deck lights !

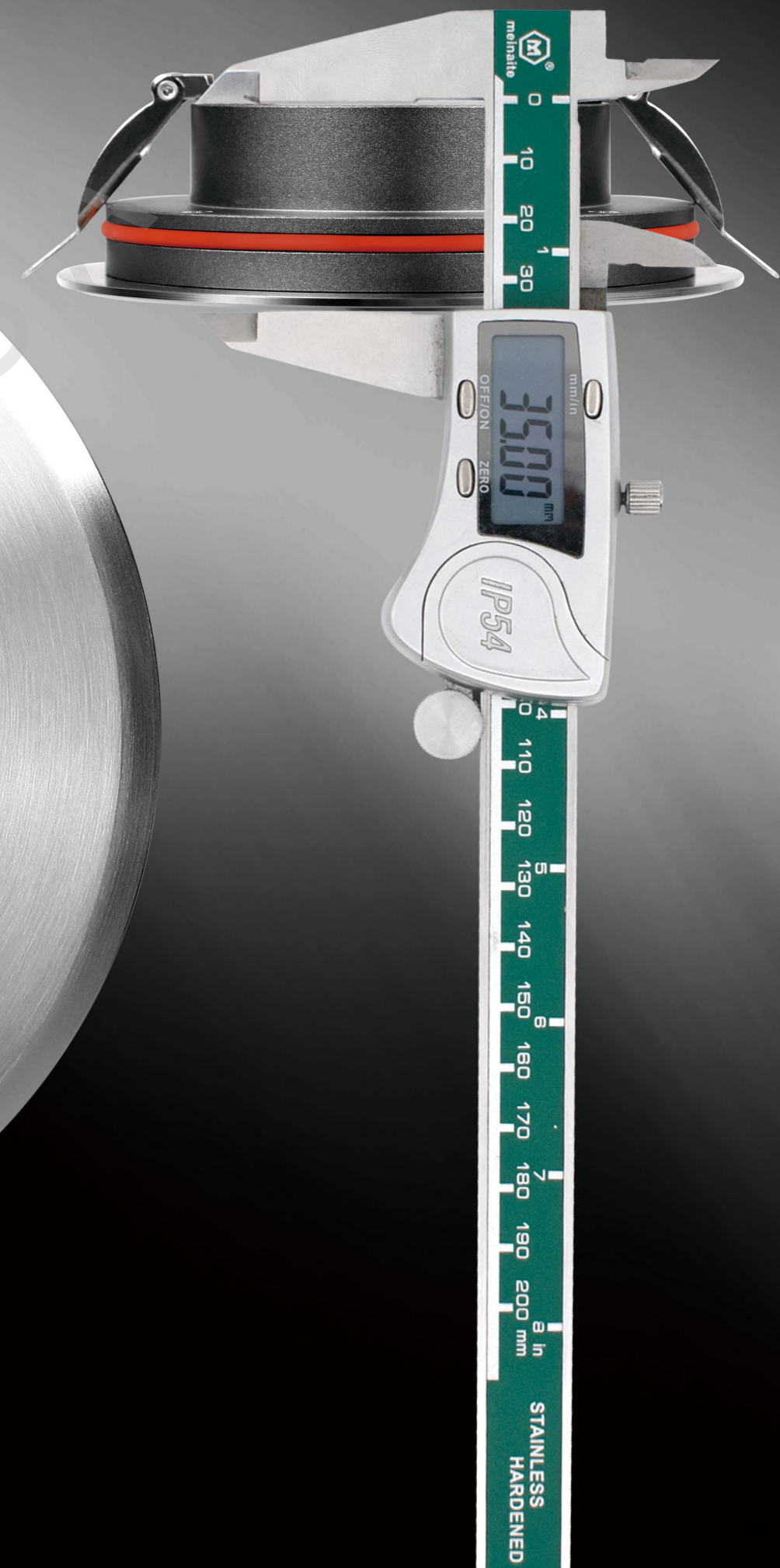
Parameter

General Data	
Item No.	UL-12W-FX-12001
Power	12 Watts +10%
LED type	15 PCS LUMILEDS 2835 SMD LED
Luminous flux	/
CCT	2700K, 3000K, 4000K, 5700K, 6500K
CRI	80+
Beam angle	130°
Dimension	Ø160x35 (mm) Diameter x length
Cut out	Ø143 mm with sleeve, Ø145mm with clip
Net weight	1.1 kgs
Warranty	1 year
Certifications	CE, RoHS
Electrical Data	
Input voltage	DC24V
Insulation class	Class III
Cable	1PC rubber cable 1M H05RN-F 2x1mm square
Driver	Low constant voltage input driver, constant current output for LEDs
Construction Data	
IP rating	IP67 Waterproof
IK rating	IK08
Housing	Solid Passivated (Anodizing) Aluminum CNC machined
Protection finishing	20~25µm thickness anodized film for housing .Dark grey
Trim	Stainless steel 316
Glass	Step tempered Glass.T=8mm.
Loading capacity	500 kgs
Cable Gland	PG gland
Gasket	O-ring PMQ silicone seal
Accessories	
Mounting Sleeve	Passivated (Anodizing) Aluminum CNC machined .Dark grey
Clip	With spring as options, that's for wall lights, deck lights application
Packaging	
Inner box size	170*170*60 mm
Carton size	33.5*33.5*11.5 cm (8 PCS / carton)



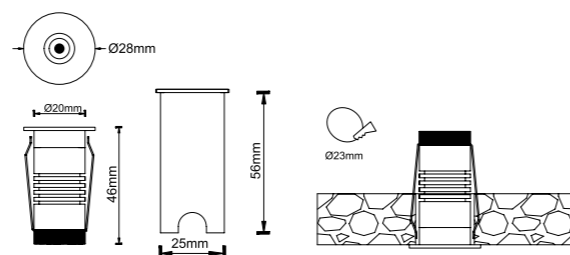
INGROUND LIGHTS SERIES

1.2 SMD LED GROUND SPOT SERIES

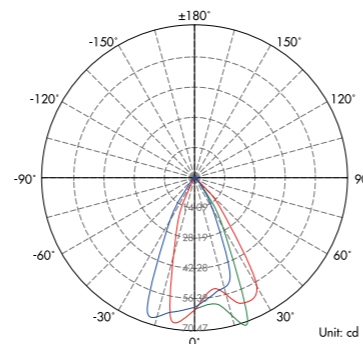




Dimension



Light Distribution Curve (3000K, 25°)



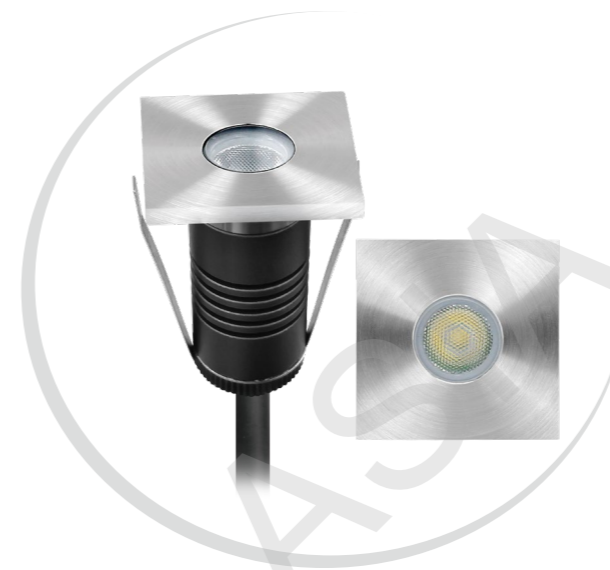
Lux distance Curve (3000K, 25°)

Illuminance at a Distance

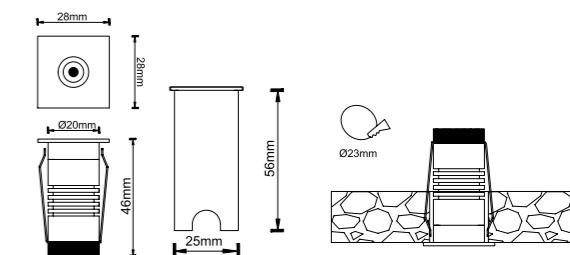
Distance (m)	Center Beam LUX		Beam Width (V x H)	
	V	H	V	H
2m	15.29 LUX	1.6m	1.6m	1.7m
4m	3.82 LUX	3.2m	3.2m	3.5m
6m	1.70 LUX	4.8m	4.8m	5.2m
8m	0.96 LUX	6.4m	6.4m	7.0m
10m	0.61 LUX	8.1m	8.1m	8.7m
12m	0.42 LUX	9.7m	9.7m	10.5m

Vert.Spread:43.9 Horiz.Spread:47.2

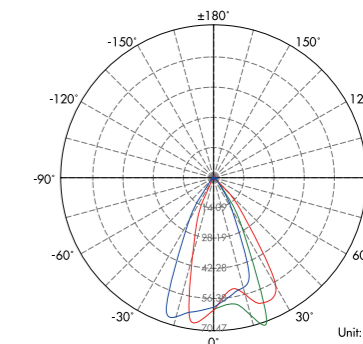
Illumination Picture (25°)



Dimension



Light Distribution Curve (3000K, 1x30°)



Lux distance Curve (3000K, 1x30°)

Illuminance at a Distance

Distance (m)	Center Beam LUX		Beam Width (V x H)	
	V	H	V	H
2m	15.29 LUX	1.6m	1.6m	1.7m
4m	3.82 LUX	3.2m	3.2m	3.5m
6m	1.70 LUX	4.8m	4.8m	5.2m
8m	0.96 LUX	6.4m	6.4m	7.0m
10m	0.61 LUX	8.1m	8.1m	8.7m
12m	0.42 LUX	9.7m	9.7m	10.5m

Vert.Spread:43.9 Horiz.Spread:47.2

Illumination Picture (1x30°)



CE RoHS COMPLIANT IP67 IK06

SSS 316 Passivated 1 Year Warranty

Parameter

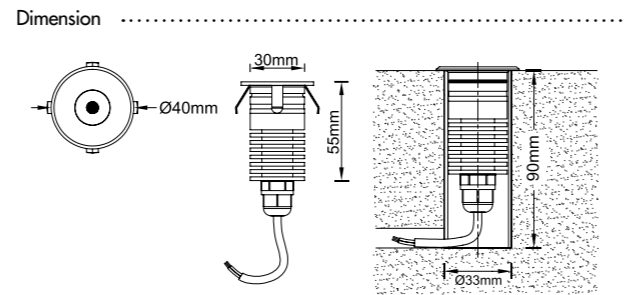
General Data	
Item No.	UL-1007-0100-B
Power	1.4 Watts
LED type	1PC OSRAM 3030 LED
Luminous flux	75-80 lm
CCT	2700, 3000K, 4000K, 6000K, R/G/Y/B
CRI	80+
Beam angle	15°, 25°, 30°, 45°, 60°, 120°
Dimension	Ø28x46 (mm) Diameter x H-Height
Cut out	25mm with sleeve / 23mm with spring
Net weight	0.072 kgs
Warranty	1 year
Certifications	CE, RoHS
Electrical Data	
Input voltage	DC 12V-DC24V
Insulation class	Class III
Cable	1PC rubber cable 0.6M H05RN-F 2x0.75mm square
Driver	Low voltage constant current output, excluding the transformer
Construction Data	
IP rating	IP67 Waterproof
IK rating	IK06
Housing	Solid Passivated (Anodizing) Aluminum CNC machined
Protection finishing	20-25µm thickness anodized film for housing. Dark grey
Trim	Stainless steel 316
Glass	Step tempered Glass. T=2mm.
Loading capacity	100 kgs
Cable Gland	IP67
Gasket	O-ring PMQ silicone seal
Accessories	
Mounting Sleeve	Anti-corrosion grey PVC
Clip	With Aluminium spring that's for deck lights or ceiling lights application
Packaging	
Inner box size	70*55*55 mm
Carton size	46*37*24 cm (160PCS / carton)

CE RoHS COMPLIANT IP67 IK06

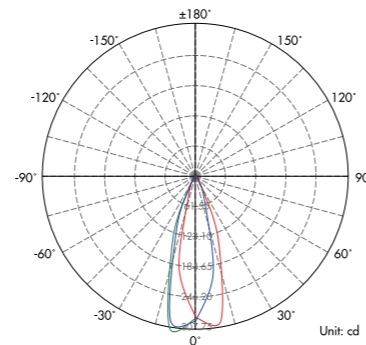
SSS 316 Passivated 1 Year Warranty

Parameter

General Data	
Item No.	UL-1007-0100-B-S
Power	1.4 Watts
LED type	1PC OSRAM 3030 LED
Luminous flux	75-80 lm
CCT	2700K, 3000K, 4000K, 6000K, R/G/Y/B
CRI	80+
Beam angle	15°, 25°, 30°, 45°, 60°, 120°
Dimension	28x28x46 (mm) Length x Width x Height
Cut out	25mm with sleeve / 23mm with spring
Net weight	0.08 kgs
Warranty	1 year
Certifications	CE, RoHS
Electrical Data	
Input voltage	DC 12V-DC24V
Insulation class	Class III
Cable	1PC rubber cable 0.6M H05RN-F 2x0.75mm square
Driver	Low voltage constant current output, excluding the transformer
Construction Data	
IP rating	IP67 Waterproof
IK rating	IK06
Housing	Solid Passivated (Anodizing) Aluminum CNC machined
Protection finishing	20-25µm thickness anodized film for housing. Dark grey
Trim	Stainless steel 316
Glass	Step tempered Glass. T=2mm.
Loading capacity	100 kgs
Cable Gland	IP67
Gasket	O-ring PMQ silicone seal
Accessories	
Mounting Sleeve	Anti-corrosion grey PVC
Clip	With Aluminium spring that's for deck lights or ceiling lights application
Packaging	
Inner box size	70*55*55 mm
Carton size	46*37*24 cm (160PCS / carton)



Light Distribution Curve (3000K, 1x43°)



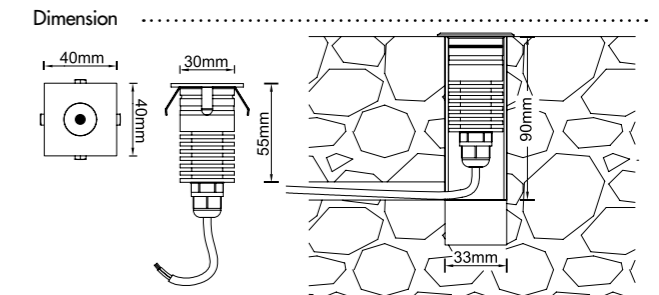
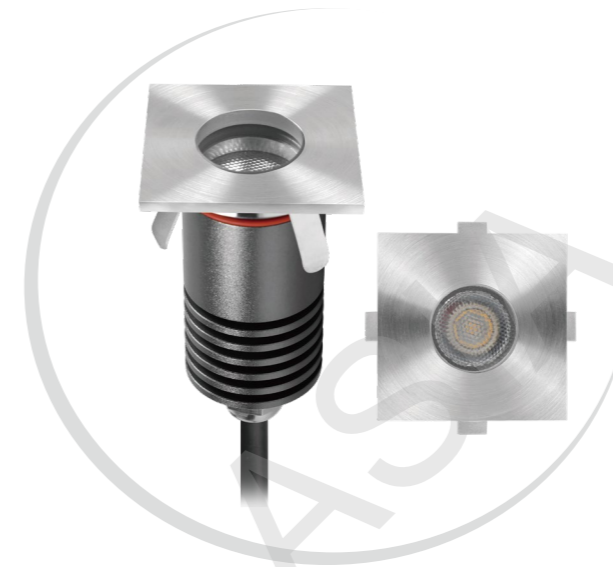
Lux distance Curve (3000K, 1x43°)

Center Beam LUX

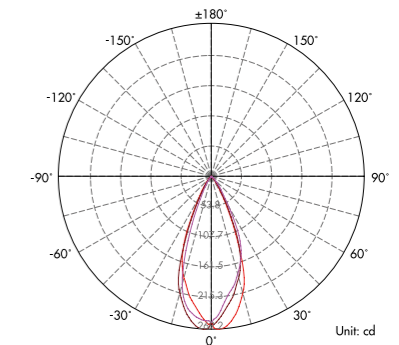
Beam Width V	Beam Width H
1.1m	1.0m
2.3m	2.1m
3.4m	3.1m
4.5m	4.2m
5.7m	5.2m
6.8m	6.3m

Vert.Spread:31.6 Horiz.Spread:29.4

Illumination Picture (1x43°)



Light Distribution Curve (3000K, 43°)



Lux distance Curve (3000K, 43°)

Illumination Picture (43°)



CE RoHS COMPLIANT IP67 IK09

SSS 316 Passivated 1 Year Warranty

Parameter	
General Data	
Item No.	UL-1003-0300-A
Power	3 Watts
LED type	1 PC 3W CREE XPE LED
Luminous flux	110-130 lm
CCT	2700K, 3000K, 4000K, 6000K, R/G/Y/B
CRI	80+
Beam angle	5°, 10°, 17°, 23°, 28°, 43°, 58° or Asymmetric 15°x15°, 15°x25°, 15°x30°, 15°x45°, 15°x60°
Dimension	Ø40x55 (mm) Diameter x length
Cut out	33 mm
Net weight	0.23 kgs
Warranty	1 year
Certifications	CE, RoHS
Electrical Data	
Input voltage	DC12V-DC24V
Insulation class	Class III
Cable	1PC rubber cable 1M H05RN-F 2x1mm square
Driver	Low voltage constant current output, excluding the transformer
Construction Data	
IP rating	IP67 Waterproof
IK rating	IK09
Housing	Solid Passivated (Anodizing) Aluminum CNC machined
Protection finishing	20-25µm thickness anodized film for housing. Dark grey
Trim	Stainless steel 316
Glass	Step tempered Glass. T=10mm.
Loading capacity	500 kgs
Cable Gland	PG7 IP67
Gasket	O-ring PMQ silicone seal
Accessories	
Mounting Sleeve	Solid Passivated (Anodizing) Aluminum CNC machined. Dark grey
Clip	With Aluminium spring that's for deck lights or ceiling lights application
Packaging	
Inner box size	110*85*60 mm
Carton size	44*24*32 cm (50PCS / carton)

CE RoHS COMPLIANT IP67 IK09

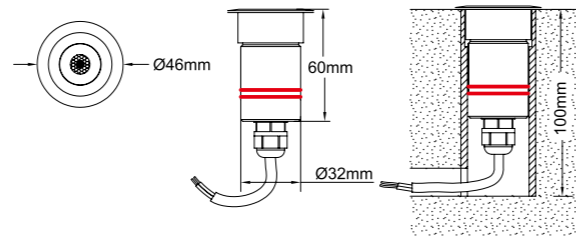
SSS 316 1 Year Warranty

Used as inground lights, deck lights !

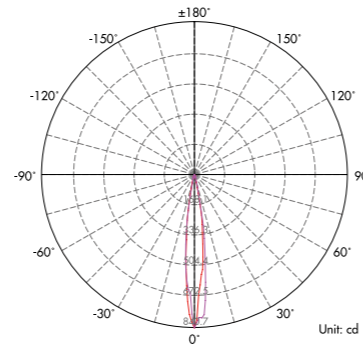
Parameter	
General Data	
Item No.	UL-1003-0300-A(B trim)
Power	3 Watts
LED type	1 PC 3W CREE XPE LED
Luminous flux	130 lm+10%
CCT	2700K, 3000K, 4000K, 6000K, R/G/Y/B
CRI	80+
Beam angle	5°, 10°, 17°, 23°, 28°, 43°, 58° or Asymmetric 15°x15°, 15°x25°, 15°x30°, 15°x45°, 15°x60°
Dimension	Ø40x55 (mm) Diameter x length
Cut out	33 mm with sleeve, 37mm with clip
Net weight	0.23 kgs
Warranty	1 year
Certifications	CE, RoHS
Electrical Data	
Input voltage	DC12V-DC24V
Insulation class	Class III
Cable	1PC rubber cable 1M H05RN-F 2x1mm square
Driver	Low voltage constant current output, excluding the transformer
Construction Data	
IP rating	IP67 Waterproof
IK rating	IK09
Housing	Solid Passivated (Anodizing) Aluminum CNC machined
Protection finishing	20-25µm thickness anodized film for housing. Dark grey
Trim	Stainless steel 316
Glass	Step tempered Glass. T=10mm.
Loading capacity	700 kgs
Cable Gland	PG gland
Gasket	O-ring PMQ silicone seal
Accessories	
Mounting Sleeve	Passivated (Anodizing) Aluminum CNC machined. Dark grey
Clip	With spring as options, that's for wall lights, deck lights or ceiling lights application
Packaging	
Inner box size	110*85*60 mm
Carton size	44*24*32 cm (50 PCS / carton)



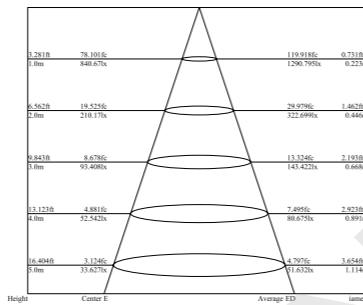
Dimension



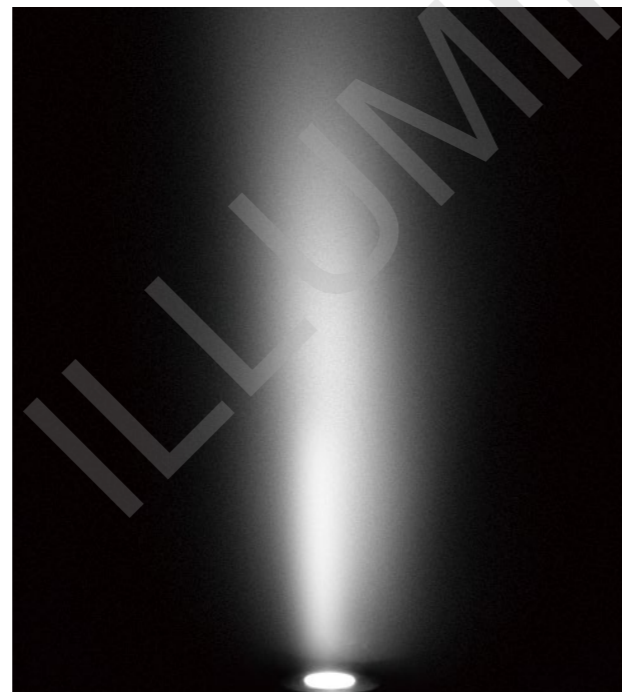
Light Distribution Curve (3000K, 15°)



Lux distance Curve (3000K, 15°)



Illumination Picture (15°)



CE RoHS COMPLIANT IP67 IK06

SSS 316 Passivated 1 Year Warranty

Parameter

General Data	
Item No.	UL-1015-0300A
Power	3 Watts
LED type	1 PC 3W CREE XPE LED
Luminous flux	110-130 lm
CCT	2700K, 3000K, 4000K, 6000K, R/G/Y/B
CRI	80+
Beam angle	15°, 25°, 38°, 45°, 60°
Dimension	Ø46x60 (mm) Diameter x length
Cut out	39 mm
Net weight	0.35 kgs
Warranty	1 year
Certifications	CE, RoHS
Electrical Data	
Input voltage	DC 12V-DC24V
Insulation class	Class III
Cable	1PC rubber cable 1M HO5RN-F 2x 1mm square
Driver	Low voltage constant current output, excluding the transformer
Construction Data	
IP rating	IP67 Waterproof
IK rating	IK06
Housing	Solid Passivated (Anodizing) Aluminum CNC machined. (Stainless steel 316 housing as options)
Protection finishing	20-25µm thickness anodized film for housing. Dark grey
Trim	Stainless steel 316
Glass	Step tempered Glass. T=6mm.
Loading capacity	320 kgs
Cable Gland	PG7 IP67
Gasket	O-ring PMQ silicone seal
Accessories	
Mounting Sleeve	Solid Passivated (Anodizing) Aluminum CNC machined. Dark grey
Packaging	
Inner box size	110*85*60 mm
Carton size	45*24*33 cm (50PCS / carton)



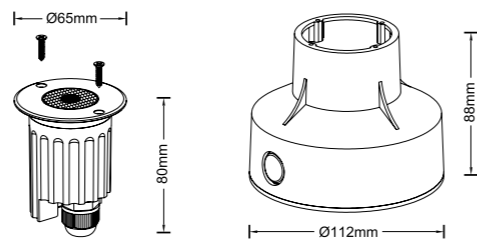


CE RoHS COMPLIANT IP67 IK06

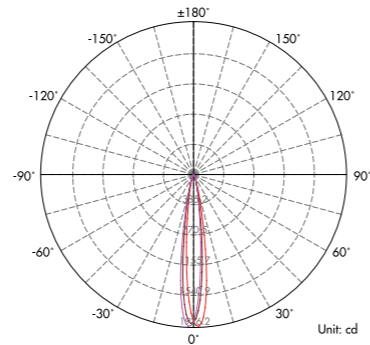
SSS 316 Passivated 1 Year Warranty

Parameter	
General Data	
Item No.	UL-1008-0500-B
Power	5 Watts
LED type	1 PC 5W CREE XPG LED
Luminous flux	350~400 lm
CCT	2700K, 3000K, 4000K, 6000K
CRI	80+
Beam angle	Symmetric: 5°, 10°, 17°, 23°, 28°, 43°, 58° Asymmetric: 15°x25°, 15°x30°, 15°x45°, 15°x60° (tilt +pan)
Dimension	Ø65x80 (mm) Diameter x length
Cut out	112 mm
Net weight	0.48 kgs
Warranty	1 year
Certifications	CE, RoHS
Electrical Data	
Input voltage	DC 12V~DC24V
Insulation class	Class III
Cable	1PC rubber cable 1M HO5RNF 2x1mm square
Driver	Low voltage constant current output, excluding the transformer
Construction Data	
IP rating	IP67 Waterproof
IK rating	IK06
Housing	Solid Passivated (Anodizing) Aluminum CNC machined
Protection finishing	20~25µm thickness anodized film for housing. Dark grey
Trim	Stainless steel 316
Glass	Step tempered Glass. T=6mm.
Loading capacity	320 kgs
Cable Gland	PG7 IP67
Gasket	O-ring PMQ silicone seal
Accessories	
Mounting Sleeve	Anti-corrosion Black PVC
Honeycomb	with honeycomb as optional
Packaging	
Inner box size	117*117*105 mm
Carton size	48.5*25*34 cm [24PCS / carton]

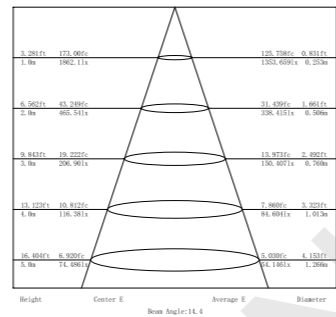
Dimension



Light Distribution Curve (3000K, 1x10°)



Lux distance Curve (3000K, 1x10°)



Illumination Picture (1x10°)

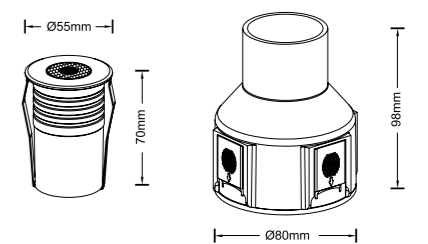


CE RoHS COMPLIANT IP67 IK06

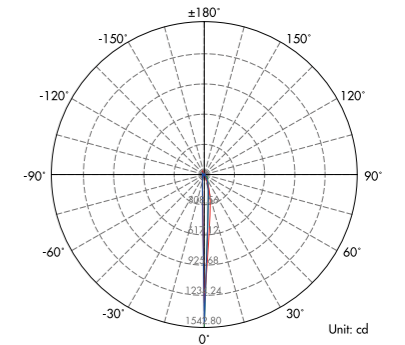
SSS 316 Passivated 1 Year Warranty

Parameter	
General Data	
Item No.	UL-1009-0300-A
Power	3 Watts
LED type	1 PC 3W CREE XPE LED
Luminous flux	110-130 lm
CCT	2700K, 3000K, 4000K, 6000K, R/G/Y/B
CRI	80+
Beam angle	20°, 30°, 40°, 60°
Dimension	Ø55x70 (mm) Diameter x length
Cut out	80 mm
Net weight	0.36 kgs
Warranty	1 year
Certifications	CE, RoHS
Electrical Data	
Input voltage	DC 12V~DC24V as standard, (AC100~245V as options)
Insulation class	Class III
Cable	1PC rubber cable 1M HO5RNF 2x1mm square
Driver	Low voltage constant current output, excluding the transformer
Construction Data	
IP rating	IP67 Waterproof
IK rating	IK06
Housing	Solid Passivated (Anodizing) Aluminum CNC machined
Protection finishing	20~25µm thickness anodized film for housing. Dark grey
Trim	Stainless steel 316
Glass	Step tempered Glass. T=6mm.
Loading capacity	320 kgs
Cable Gland	PG7 IP67
Gasket	O-ring PMQ silicone seal
Accessories	
Mounting Sleeve	Anti-corrosion Black PVC
Packaging	
Inner box size	88*88*105 mm
Carton size	46*28.5*24 cm [50PCS / carton]

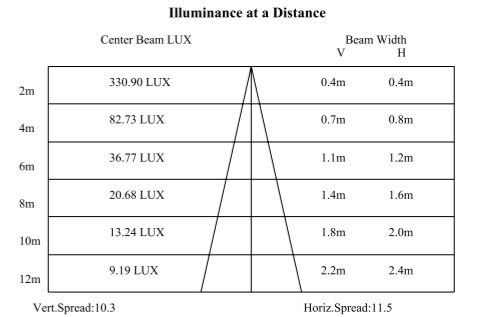
Dimension



Light Distribution Curve (3000K, 1x20°)



Lux distance Curve (3000K, 1x20°)



Illumination Picture (1x20°)



Narrow 10W



CE RoHS COMPLIANT IP67 IK08

SSS 316 1 Year Warranty

Narrow beam 3°!
Average lux: 92 lx @20m; 41 lx @30m

Parameter

General Data

Item No.	AC100-265V: UL-10W-COB-1000-AH / DC24V: UL-10W-COB-1000-A
Power	10 Watts ± 10%
LED type	1PC 10W CREE XHP35 LED
Luminous flux	600 lm ± 10%
CCT	2700K, 3000K, 4000K, 6000K
CRI	80+
Beam angle	3°
Dimension	Ø78x75 (mm) Diameter x length
Cut out	Ø68mm
Net weight	0.54 kgs
Warranty	1 year
Certifications	CE, RoHS

Electrical Data

Input voltage	AC100-265V or DC24V optional
Insulation class	Class I or Class III
Cable	1PC rubber cable 1M HO5RN-F 3 or 2x1mm square with builtin high voltage constant current driver or Low constant voltage input, constant current output driver for LEDs

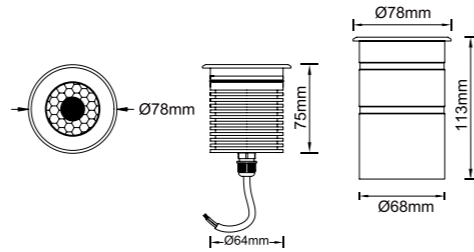
Construction Data

IP rating	IP67 Waterproof
IK rating	IK08
Housing	Solid Passivated (Anodizing) Aluminum CNC machined
Protection finishing	20-25µm thickness anodized film for housing. Dark grey
Trim	Stainless steel 316
Glass	Step tempered Glass. T=8mm.
Loading capacity	500 kgs
Cable Gland	PG gland
Gasket	O-ring PMQ silicone seal

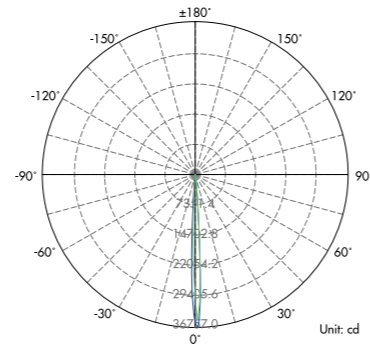
Accessories

Mounting Sleeve	Passivated (Anodizing) Aluminum CNC machined. Dark grey
Packaging	
Inner box size	85*85*120mm
Carton size	45*36*14cm (20 PCS/carton)

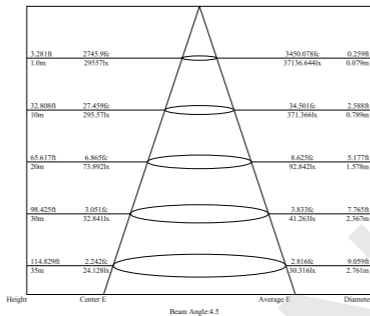
Dimension



Light Distribution Curve (3°)



Lux distance Curve (3°)

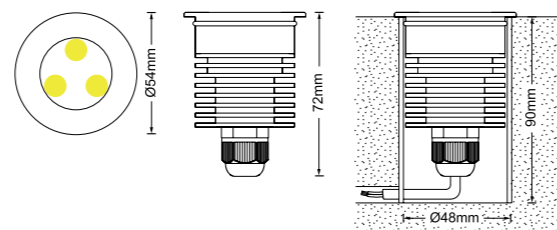


Illumination Picture (3°)

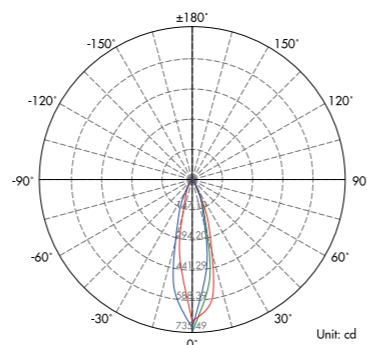




Dimension



Light Distribution Curve (3000K, 1x25°)



Lux distance Curve (3000K, 1x25°)

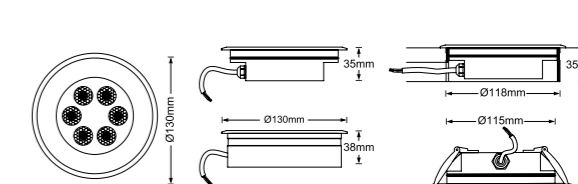
	Illuminance at a Distance	
	Center Beam LUX	Beam Width V H
2m	170.99 LUX	0.9m 1.0m
4m	42.75 LUX	1.9m 1.9m
6m	19.00 LUX	2.8m 2.9m
8m	10.69 LUX	3.8m 3.8m
10m	6.84 LUX	4.7m 4.8m
12m	4.75 LUX	5.6m 5.8m

Vert.Spread:26.5 Horiz.Spread:27.0

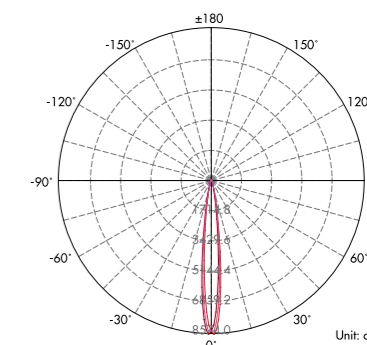
Illumination Picture (1x25°)



Dimension



Light Distribution Curve (3000K, 17°)



Lux distance Curve (3000K, 17°)

Height	Center E	Beam Angle: 17.0	Average E	Diameter
3.281ft	779.02fc		564.662fc	0.687ft
1.0m	8385.4lx		6078.021lx	0.209m
6.562ft	194.75fc		141.165fc	1.374ft
2.0m	2096.3lx		1519.505lx	0.419m
9.843ft	86.558fc		62.740fc	2.061ft
3.0m	931.71lx		675.336lx	0.628m
13.123ft	48.689fc		35.291fc	2.748ft
4.0m	524.09lx		379.876lx	0.837m
16.404ft	31.161lx		22.586lx	3.434ft
5.0m	335.41lx		243.121lx	1.047m

Illumination Picture (17°)



CE RoHS COMPLIANT IP67 IK07

SSS 316 Passivated 1 Year Warranty

Parameter

General Data	
Item No.	UL-3005-0300-A
Power	3 Watts
LED type	3 PCS 1W CREE XPE LED
Luminous flux	230-260 lm
CCT	2700K, 3000K, 4000K, 6000K, R/G/Y/B
CRI	80+
Beam angle	25°, 45°
Dimension	Ø54x72 (mm) Diameter x length
Cut out	48 mm
Net weight	0.310 kgs
Warranty	1 year
Certifications	CE, RoHS
Electrical Data	
Input voltage	DC 12V-DC24V as standard, (AC 100-245V as options)
Insulation class	Class III
Cable	1PC rubber cable 1M H05RN-F 2x1mm square
Driver	Low voltage constant current output, excluding the transformer
Construction Data	
IP rating	IP67 Waterproof
IK rating	IK07
Housing	Solid Passivated (Anodizing) Aluminum CNC machined
Protection finishing	20-25µm thickness anodized film for housing. Dark grey
Trim	Stainless steel 316
Glass	Step tempered Glass. T=8mm.
Loading capacity	610 kgs
Cable Gland	PG7 IP67
Gasket	O-ring PMQ silicone seal
Accessories	
Mounting Sleeve	Passivated (Anodizing) Aluminum CNC machined. Dark grey
Packaging	
Inner box size	90*59*100 mm
Carton size	46.8*31.3*21.8 cm (50PCS / carton)

CE RoHS COMPLIANT IP67 IK08

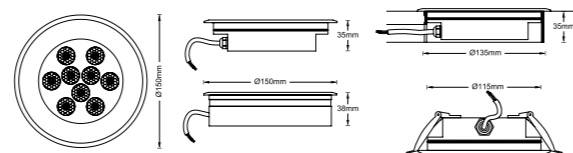
Ultra slim Passivated 1 Year Warranty

Parameter

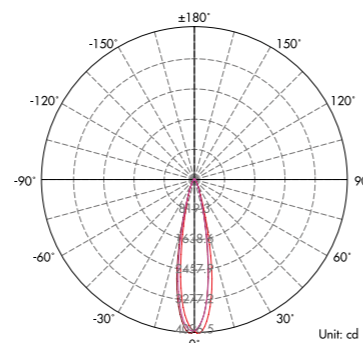
General Data	
Item No.	UL-6001-0900H
Power	9 Watts
LED type	6 PCS OSRAM SMD LED
Luminous flux	480-540lm
CCT	2700K, 3000K, 4000K, 6000K
CRI	80+
Beam angle	Symmetric: 5°, 10°, 17°, 23°, 28°, 43°, 58° Asymmetric: 15°x25°, 15°x30°, 15°x45°, 15°x60° (tilt +pan)
Dimension	Ø130x35 (mm) Diameter x Height
Cut out	Inground light: Ø118 mm Deck light: Ø115 mm
Net weight	0.72 KGS
Warranty	1 year
Certifications	CE, RoHS
Electrical Data	
Input voltage	DC 24V
Insulation class	Class III
Cable	1PC rubber cable 1M H05RN-F 2x1mm square
Driver	Built-in low voltage constant current driver without transformer
Control	ON/OFF / PWM
Construction Data	
IP rating	IP67 Waterproof
IK rating	IK08
Housing	Solid Passivated (Anodizing) Aluminum CNC machined
Protection finishing	20-25µm thickness anodized film for housing. Dark grey color
Trim	Stainless steel 316
Glass	Step tempered Glass. T=8mm.
Loading capacity	2000 kgs
Cable Gland	PG7 IP67
Gasket	O-ring PMQ silicone seal
Accessories	
Mounting sleeve	Aluminium sleeve used as inground light
Clip	Two clips with screws optional used as downlight / deck light
Packaging	
Inner box size	140*140*60 mm
Carton size	30.5*30.5*20.5CM (12PCS/CTN)



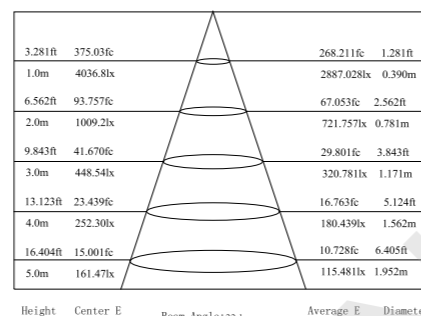
Dimension



Light Distribution Curve (3000K, 17°)



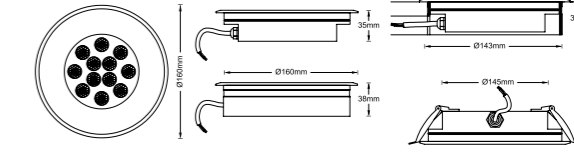
Lux distance Curve (3000K, 17°)



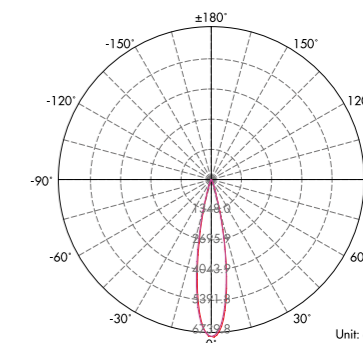
Illumination Picture (17°)



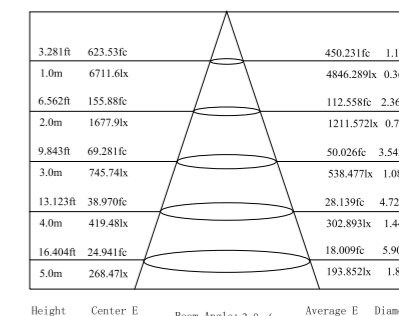
Dimension



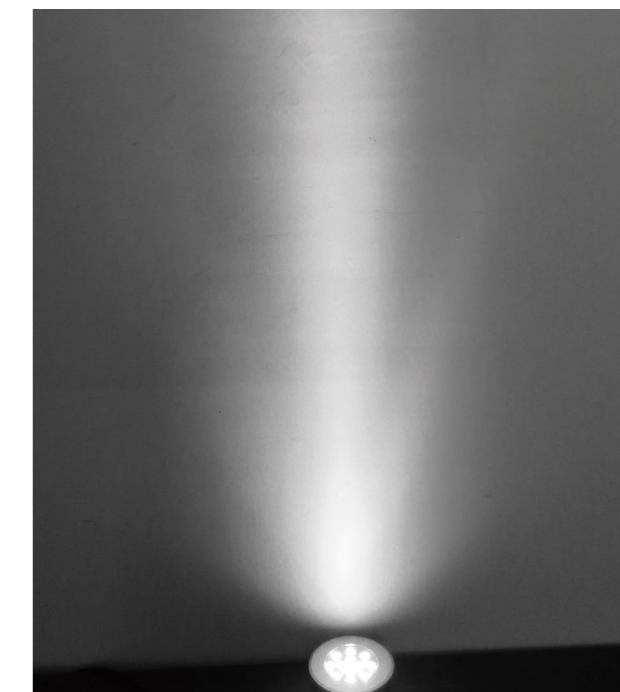
Light Distribution Curve (3000K, 10°)



Lux distance Curve (3000K, 10°)



Illumination Picture (10°)



CE RoHS COMPLIANT IP67 IK08

Ultra slim Passivated 1 Year Warranty

Parameter

General Data	
Item No.	UL-9001-1200H
Power	12 Watts
LED type	9 PCS OSRAM SMD LED
Luminous flux	720-810lm
CCT	2700K, 3000K, 4000K, 6000K
CRI	80+
Beam angle	Symmetric: 5°, 10°, 17°, 23°, 28°, 43°, 58° Asymmetric: 15°x25°, 15°x30°, 15°x45°, 15°x60° (tilt +pan)
Dimension	Ø150x35 (mm) Diameter x Height
Cut out	Inground light: Ø135mm Deck light: Ø135mm
Net weight	0.98 KGS
Warranty	1 year
Certifications	CE, RoHS
Electrical Data	
Input voltage	DC 24V
Insulation class	Class III
Cable	1PC rubber cable 1M H05RN-F 2x1mm square
Driver	Built-in low voltage constant current driver without transformer
Control	ON\OFF / PWM
Construction Data	
IP rating	IP67 Waterproof
IK rating	IK08
Housing	Solid Passivated (Anodizing) Aluminum CNC machined
Protection finishing	20~25µm thickness anodized film for housing. Dark grey color
Trim	Stainless steel 316
Glass	Step tempered Glass. T=8mm.
Loading capacity	2000 kgs
Cable Gland	PG7 IP67
Gasket	O-ring PMQ silicone seal
Accessories	
Mounting sleeve	Aluminium sleeve used as inground light
Clip	Two clips with screws optional used as downlight / deck light
Packaging	
Inner box size	160*160*60 mm
Carton size	34.5*34.5*20.5CM (12PCS/CTN)

CE RoHS COMPLIANT IP67 IK08

Ultra slim Passivated 1 Year Warranty

Parameter

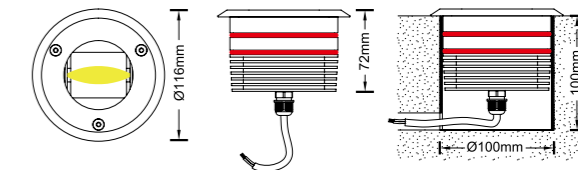
General Data	
Item No.	UL-1201-1500H
Power	15 Watts
LED type	12 PCS OSRAM SMD LED
Luminous flux	960-1080lm
CCT	2700K, 3000K, 4000K, 6000K
CRI	80+
Beam angle	Symmetric: 5°, 10°, 17°, 23°, 28°, 43°, 58° Asymmetric: 15°x25°, 15°x30°, 15°x45°, 15°x60° (tilt +pan)
Dimension	Ø160x35 (mm) Diameter x Height
Cut out	Inground light: Ø143mm Deck light: Ø145mm
Net weight	1.1 KGS
Warranty	1 year
Certifications	CE, RoHS
Electrical Data	
Input voltage	DC 24V
Insulation class	Class III
Cable	1PC rubber cable 1M H05RN-F 2x1mm square
Driver	Built-in low voltage constant current driver without transformer
Control	ON\OFF / PWM
Construction Data	
IP rating	IP67 Waterproof
IK rating	IK08
Housing	Solid Passivated (Anodizing) Aluminum CNC machined
Protection finishing	20~25µm thickness anodized film for housing. Dark grey color
Trim	Stainless steel 316
Glass	Step tempered Glass. T=8mm.
Loading capacity	2000 kgs
Cable Gland	PG7 IP67
Gasket	O-ring PMQ silicone seal
Accessories	
Mounting sleeve	Aluminium sleeve used as inground light
Clip	Two clips with screws optional used as downlight / deck light
Packaging	
Inner box size	170*170*60 mm
Carton size	36.5*36.5*14CM (8PCS/CTN)



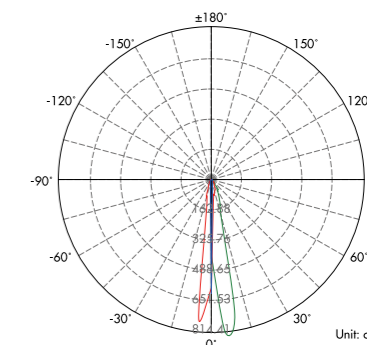
CE RoHS COMPLIANT IP67 IK09

SSS 316 Passivated 1 Year Warranty

Dimension



Light Distribution Curve (3000K, 2°+2°+2° (similar with a door)



Lux distance Curve (3000K, 2°+2°+2° (similar with a door)

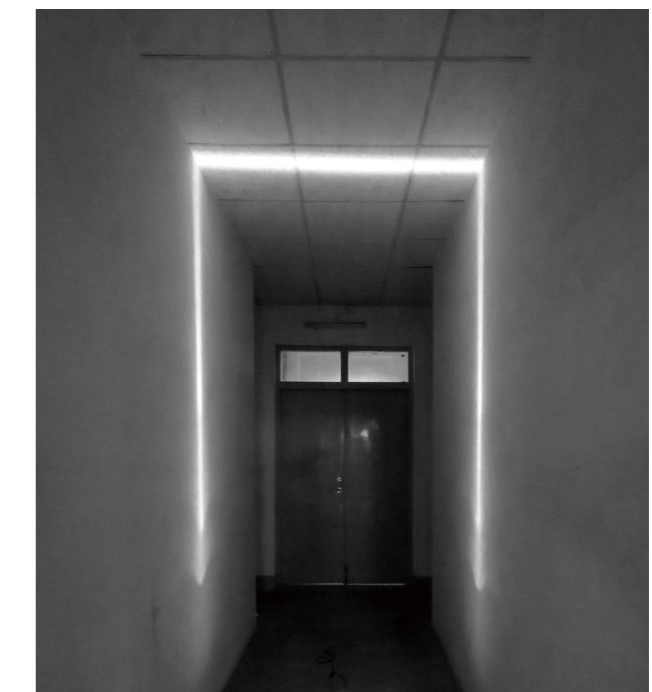
	Illuminance at a Distance	
	Center Beam LUX	Beam Width V H
2m	143.78 LUX	0.4m 0.1m
4m	35.94 LUX	0.7m 0.2m
6m	15.98 LUX	1.1m 0.4m
8m	8.99 LUX	1.5m 0.5m
10m	5.75 LUX	1.8m 0.6m
12m	3.99 LUX	2.2m 0.7m

Vert.Spread:10.5 Horiz.Spread:3.4

Parameter

General Data	
Item No.	UL-3001-0900A
Power	9 Watts
LED type	3 PCS 3W CREE XPG LED
Luminous flux	280~300 lm
CCT	2700K, 3000K, 4000K, 6000K
CRI	80+
Beam angle	One beam with 2°+2°+2° (similar with a door)
Dimension	116 x 72 (mm) Diameter x Height
Cut out	100 mm
Net weight	1.24 kgs
Warranty	1 year
Certifications	CE, RoHS
Electrical Data	
Input voltage	DC24V
Insulation class	Class III
Cable	1PC rubber cable 1M H05RN-F 2x1mm square
Driver	Low voltage constant current output, excluding the transformer
Construction Data	
IP rating	IP67 Waterproof
IK rating	IK09
Housing	Solid Passivated (Anodizing) Aluminum CNC machined
Protection finishing	20~25µm thickness anodized film for housing. Dark grey
Trim	Stainless steel 316
Glass	Step tempered Glass. T=8mm.
Loading capacity	2000 kgs
Cable Gland	PG7 IP67
Gasket	O-ring PMQ silicone seal
Accessories	
Mounting Sleeve	Passivated (Anodizing) Aluminum CNC machined. Dark grey
Packaging	
Inner box size	121 * 121 * 112 mm
Carton size	38 * 26 * 24 cm (12 PCS / carton)

Illumination Picture (2°+2°+2° (similar with a door)



INGROUND LIGHTS SERIES



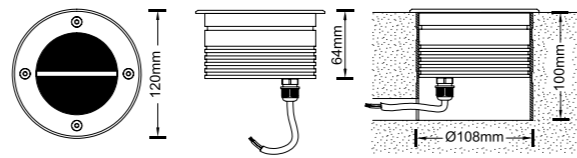
CE RoHS COMPLIANT IP67 IK08

SSS 316 Passivated 1 Year Warranty

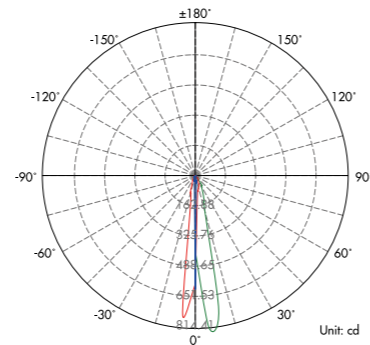
Parameter

General Data	
Item No.	UL3001-1000-B
Power	10 Watts
LED type	5PCS 2W CREE XPE LED
Luminous flux	153~200lm
CCT	2700K, 3000K, 4000K, 6000K
CRI	80+
Beam angle	2° one beam as uplight or 2°+2°+2° as a gallery light
Dimension	Ø120x64 (mm) Diameter x length
Cut out	108 mm
Net weight	1.238 kgs
Warranty	1 year
Certifications	CE, RoHS
Electrical Data	
Input voltage	DC24V
Insulation class	Class III
Cable	1PC rubber cable 1M H05RN-F 2x1mm square
Driver	Low voltage constant current output, excluding the transformer
Construction Data	
IP rating	IP67 Waterproof
IK rating	IK08
Housing	Solid Passivated (Anodizing) Aluminum CNC machined
Protection finishing	20~25µm thickness anodized film for housing. Dark grey
Trim	Stainless steel 316
Glass	Step tempered Glass. T=6mm.
Loading capacity	2000 kgs
Cable Gland	PG7 IP67
Gasket	O-ring PMQ silicone seal
Accessories	
Mounting Sleeve	Passivated (Anodizing) Aluminum CNC machined. Dark grey
Packaging	
Inner box size	130*130*110 mm
Carton size	28*28*24.5 cm (8PCS / carton)

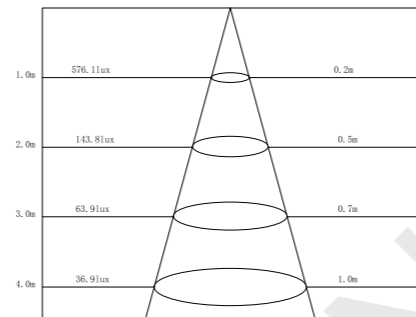
Dimension



Light Distribution Curve



Lux distance Curve

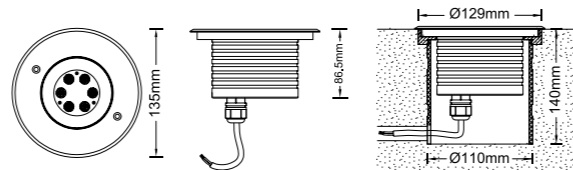


Illumination Picture (2° one beam as uplight or 2°+2°+2° as a gallery light)

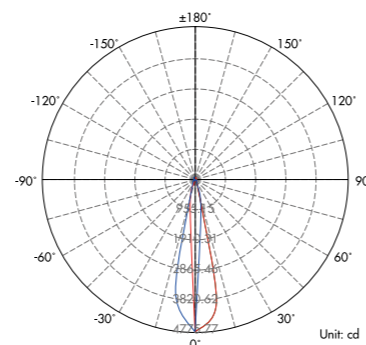




Dimension



Light Distribution Curve (3000K,22°)



Lux distance Curve (3000K,22°)

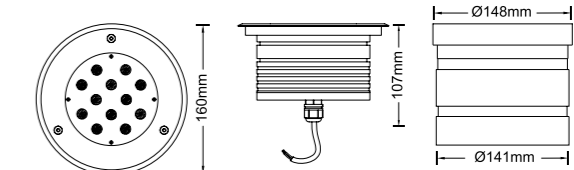
Distance (m)	Illuminance at a Distance	
	Center Beam LUX	Beam Width V x H
2m	1193.94 LUX	0.7m x 0.7m
4m	298.49 LUX	1.4m x 1.4m
6m	132.66 LUX	2.1m x 2.1m
8m	74.62 LUX	2.9m x 2.8m
10m	47.76 LUX	3.6m x 3.5m
12m	33.17 LUX	4.3m x 4.2m

Vert.Spread:20.3 Horiz.Spread:20.0

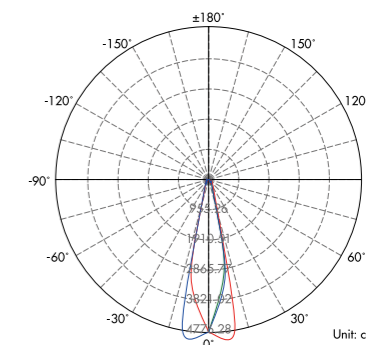
Illumination Picture (22°)



Dimension



Light Distribution Curve (3000K,22°)



Lux distance Curve (3000K,22°)

Distance (m)	Illuminance at a Distance	
	Center Beam LUX	Beam Width V x H
2m	1194.03 LUX	1.0m x 1.0m
4m	298.51 LUX	2.0m x 2.0m
6m	132.67 LUX	3.0m x 3.0m
8m	74.63 LUX	4.0m x 4.0m
10m	47.76 LUX	5.0m x 4.9m
12m	33.17 LUX	6.0m x 5.9m

Vert.Spread:28.1 Horiz.Spread:27.8

Illumination Picture (22°)



CE RoHS COMPLIANT IP67 IK09

SSS 316 Passivated 1 Year Warranty

Parameter

General Data	
Item No.	UL-6002-1800-BH
Power	12 Watts as standard (18 watts as options)
LED type	6PCS CREE XPE LED
Luminous flux	650~750 lm
CCT	2700K, 3000K, 4000K, 6000K, R/G/Y/B
CRI	80+
Beam angle	Symmetric: 5°, 10°, 17°, 23°, 28°, 43°, 58° Asymmetric: 15°x25°, 15°x30°, 15°x45°, 15°x60° (tilt +pan)
Dimension	135x86.5 (mm) Diameter x Height
Cut out	110 mm
Net weight	1.543kgs
Warranty	1 year
Certifications	CE, RoHS
Electrical Data	
Input voltage	AC95-265V
Insulation class	Class I
Cable	1PC rubber cable 1M H05RN-F 3x1mm square
Driver	Built-in high voltage constant current driver with transformer
Construction Data	
IP rating	IP67 Waterproof
IK rating	IK09
Housing	Solid Passivated (Anodizing) Aluminum CNC machined
Protection finishing	20~25µm thickness anodized film for housing
Trim	Stainless steel 316
Glass	Step tempered Glass. T=8mm.
Loading capacity	2000 kgs
Cable Gland	PG9 IP67
Gasket	O-ring PMQ silicone seal
Accessories	
Mounting Sleeve	Anti-corrosion grey PVC, with screws fixed
Packaging	
Inner box size	150*150*145 mm
Carton size	47*32*31 cm (12PCS / carton)

CE RoHS COMPLIANT IP67 IK09

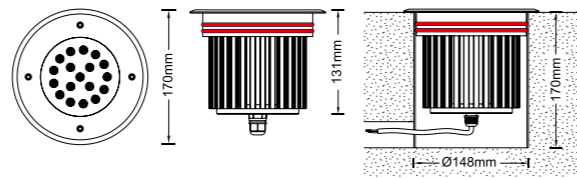
SSS 316 Passivated 1 Year Warranty

Parameter

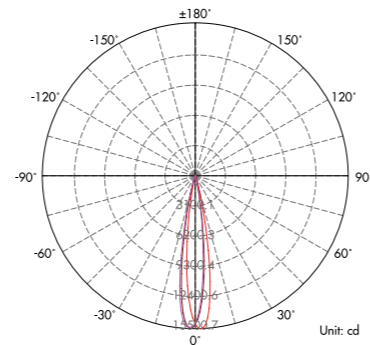
General Data	
Item No.	UL-1202-2400-AH
Power	24 Watts
LED type	12 PCS 2W CREE XPE LED
Luminous flux	1500~1600 lm
CCT	2700K, 3000K, 4000K, 6000K, R/G/Y/B
CRI	80+
Beam angle	Symmetric: 5°, 10°, 17°, 23°, 28°, 43°, 58° Asymmetric: 15°x25°, 15°x30°, 15°x45°, 15°x60° (tilt +pan)
Dimension	160x107 (mm) Diameter x Height
Cut out	148 mm
Net weight	2.985 kgs
Warranty	1 year
Certifications	CE, RoHS
Electrical Data	
Input voltage	AC95-265V
Insulation class	Class I
Cable	1PC rubber cable 1M H05RN-F 3x1mm square
Driver	Built-in high voltage constant current driver with transformer
Construction Data	
IP rating	IP67 Waterproof
IK rating	IK09
Housing	Solid Passivated (Anodizing) Aluminum CNC machined
Protection finishing	20~25µm thickness anodized film for housing
Trim	Stainless steel 316
Glass	Step tempered Glass. T=10 mm.
Loading capacity	2000 kgs
Cable Gland	PG9 IP67
Gasket	O-ring PMQ silicone seal
Accessories	
Mounting Sleeve	Anti-corrosion grey PVC, with screws fixed
Packaging	
Inner box size	170*170*140 mm
Carton size	35.5*35.5*16 cm (4PCS / carton)



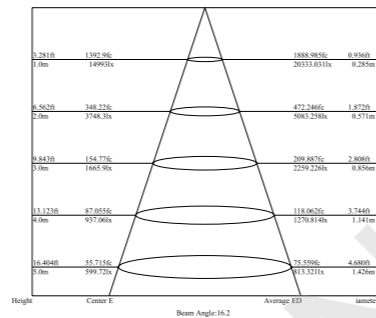
Dimension



Light Distribution Curve (3000K,15°)



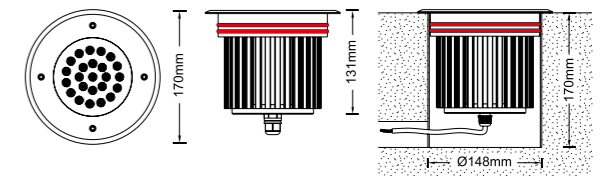
Lux distance Curve (3000K,15°)



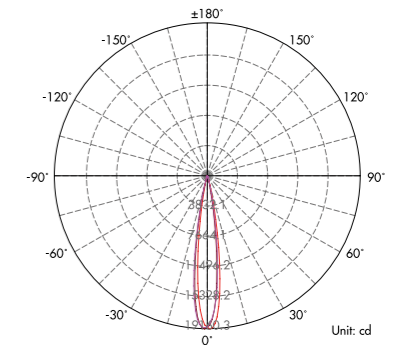
Illumination Picture (15°)



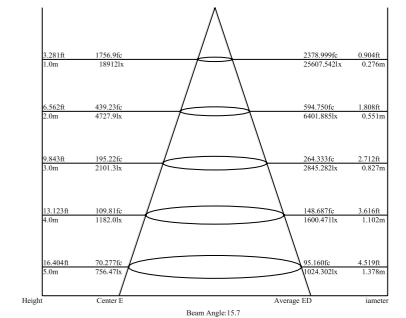
Dimension



Light Distribution Curve (3000K,15°)



Lux distance Curve (3000K,15°)



Illumination Picture (15°)



CE RoHS COMPLIANT IP67 IK09

SSS 316 Passivated 1 Year Warranty

Parameter

General Data	
Item No.	UL-1802-3000-A
Power	30 Watts
LED type	18 PCS CREE XPE LED
Luminous flux	1750~1850 lm
CCT	2700K, 3000K, 4000K, 6000K, R/G/Y/B
CRI	80+
Beam angle	15°, 24°, 36°
Dimension	170x131 (mm) Diameter x Height
Cut out	148 mm
Net weight	3.688kgs
Warranty	1 year
Certifications	CE, RoHS
Electrical Data	
Input voltage	AC96~265V
Insulation class	Class I
Cable	1PC rubber cable 1M H05RN-F 3x1mm square
Driver	Built-in high voltage constant current driver with transformer
Construction Data	
IP rating	IP67 Waterproof
IK rating	IK09
Housing	Solid Passivated (Anodizing) Aluminum CNC machined
Protection finishing	20~25µm thickness anodized film for housing, Dark grey
Trim	Stainless steel 316
Glass	Step tempered Glass. T=10mm.
Loading capacity	2000 kgs
Cable Gland	PG7 IP67
Gasket	O-ring PMQ silicone seal
Accessories	
Mounting Sleeve	Passivated (Anodizing) Aluminum CNC machined
Packaging	
Inner box size	178*178*185 mm
Carton size	37.5*37.5*22.5 cm (4PCS / carton)

CE RoHS COMPLIANT IP67 IK09

SSS 316 Passivated 1 Year Warranty

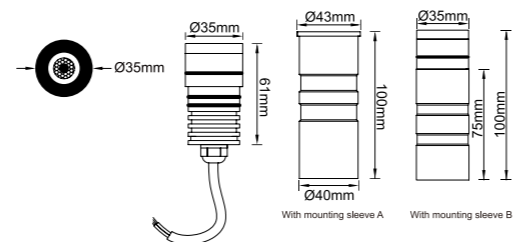
Parameter

General Data	
Item No.	UL-2402-4000-AH
Power	40 Watts
LED type	24 PCS CREE XPE LED
Luminous flux	2320~2500 lm
CCT	2700K, 3000K, 4000K, 6000K, R/G/Y/B
CRI	80+
Beam angle	15°, 24°, 36°
Dimension	170 x 131 (mm) Diameter x Height
Cut out	148 mm
Net weight	3.693kgs
Warranty	1 year
Certifications	CE, RoHS
Electrical Data	
Input voltage	AC96~265V
Insulation class	Class I
Cable	1PC rubber cable 1M H05RN-F 3x1mm square
Driver	Built-in high voltage constant current driver with transformer
Construction Data	
IP rating	IP67 Waterproof
IK rating	IK09
Housing	Solid Passivated (Anodizing) Aluminum CNC machined
Protection finishing	20~25µm thickness anodized film for housing, Dark grey
Trim	Stainless steel 316
Glass	Step tempered Glass. T=10mm.
Loading capacity	2000 kgs
Cable Gland	PG7 IP67
Gasket	O-ring PMQ silicone seal
Accessories	
Mounting Sleeve	Passivated (Anodizing) Aluminum CNC machined
Packaging	
Inner box size	178*178*185 mm
Carton size	37.5*37.5*22.5 cm (4PCS / carton)

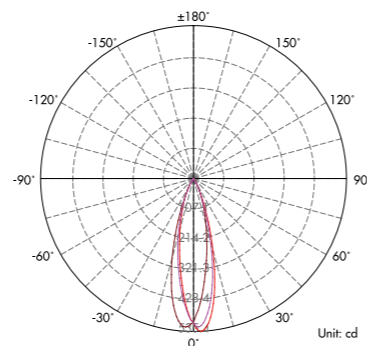
Rimless mini



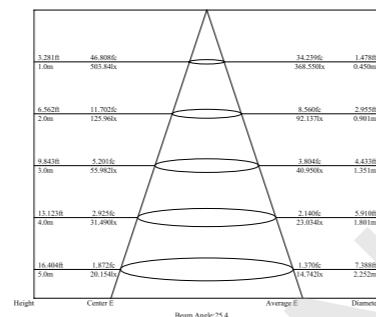
Dimension



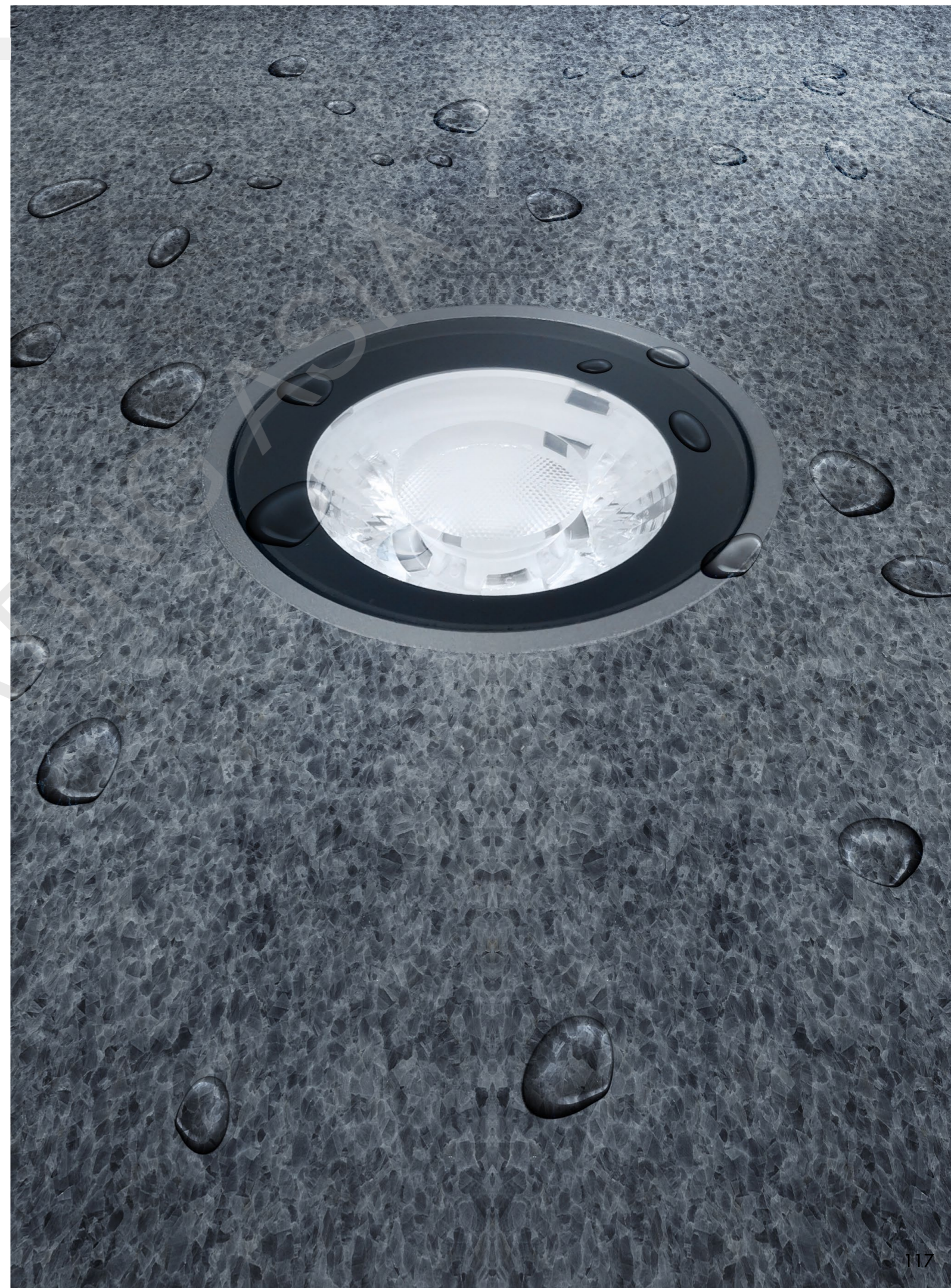
Light Distribution Curve (3000K, 25°)



Lux distance Curve (3000K, 25°)



Illumination Picture (25°)



CE RoHS COMPLIANT IP67 IK06

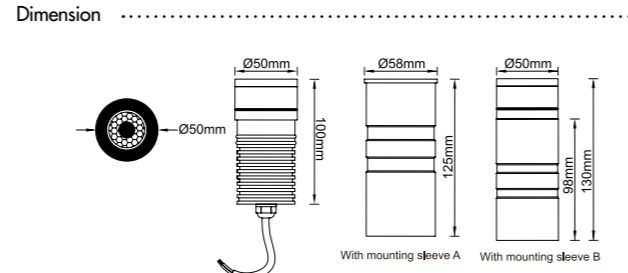
1 Year Warranty

Whole glass surface!
Two different installation possibilities with mounting sleeve A or B.

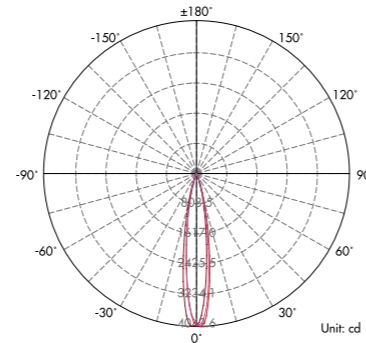
Parameter

General Data	
Item No.	UL-1024-0300-A
Power	3 Watts ± 10%
LED type	1 PC 3W OSRAM 3030 SMD LED
Luminous flux	150lm ± 10%
CCT	2700K, 3000K, 4000K, 6000K
CRI	80+
Beam angle	11°, 15°, 25°, 30°, 45°, 60° (100° frosted glass optional)
Dimension	Ø35x61 (mm) Diameter x Height
Cut out	Ø43mm for mounting sleeve A, Ø35mm for mounting sleeve B
Net weight	0.3 kgs
Warranty	1 year
Certifications	CE, RoHS
Electrical Data	
Input voltage	DC12V-DC24V
Insulation class	Class III
Cable	1PC rubber cable 1M H05RN-F 2x1mm square
Driver	Low voltage constant current output, excluding the AC transformer
Construction Data	
IP rating	IP67 Waterproof
IK rating	IK06
Housing	Solid Passivated (Anodizing) Aluminum CNC machined
Protection finishing	20~25µm thickness anodized film for housing. Dark grey
Trim	Whole glass
Glass	Step tempered Glass.T=6mm.
Loading capacity	300 kgs
Cable Gland	PG gland
Gasket	PMQ silicone seal
Accessories	
Mounting Sleeve	Passivated (Anodizing) Aluminum. Dark grey. Type A or B optional
Suction cap	With suction cap for pulling the lamp
Packaging	
Inner box size	110x85x60 mm
Carton size	45x35.5x20.5 cm (45PCS / carton)

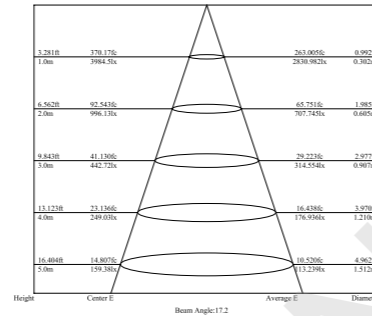
Rimless midi



Light Distribution Curve (3000K, 15°)



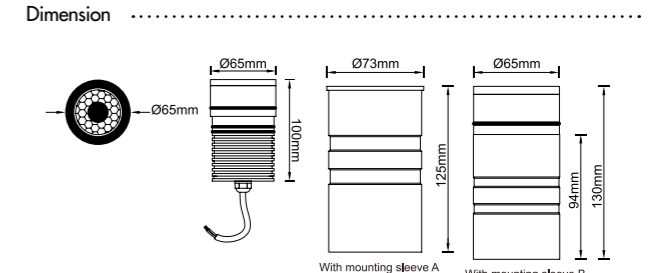
Lux distance Curve (3000K, 15°)



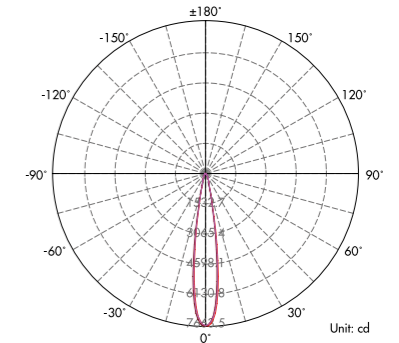
Illumination Picture (15°)



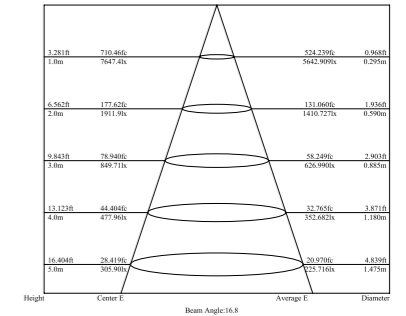
Rimless maxi



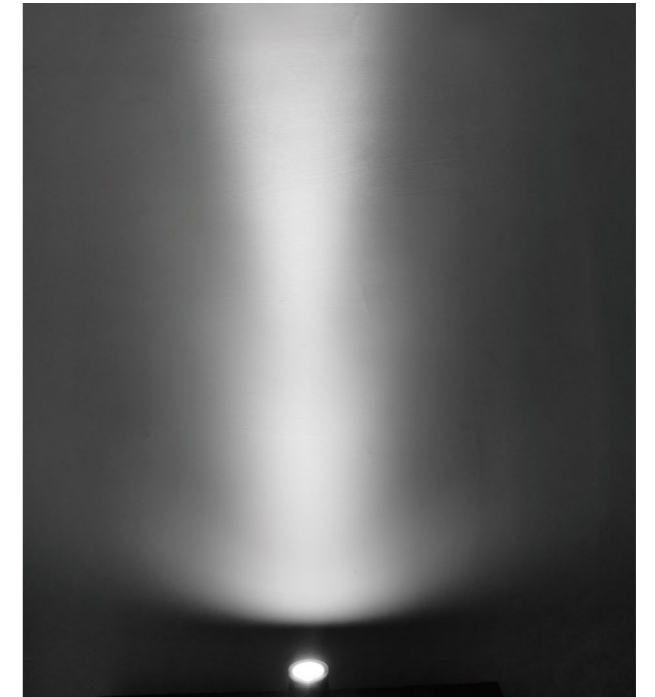
Light Distribution Curve (3000K, 10°)



Lux distance Curve (3000K, 10°)



Illumination Picture (10°)



CE RoHS COMPLIANT IP67 IK06

1 Year Warranty

Whole glass surface!
Two different installation possibilities with mounting sleeve A or B.

Parameter

General Data	
Item No.	UL-8W-COB-0800-D
Power	8 Watts ± 10%
LED type	1 PC 8W CREE COB LED CXA1304
Luminous flux	600lm ± 10%
CCT	2700K, 3000K, 4000K, 6000K
CRI	80+
Beam angle	15°, 24°, 36°, 60° (100° frosted glass optional)
Dimension	Ø50x100 (mm) Diameter x Height
Cut out	Ø58mm for mounting sleeve A, Ø50mm for mounting sleeve B
Net weight	0.65 kgs
Warranty	1 year
Certifications	CE, RoHS
Electrical Data	
Input voltage	DC24V
Insulation class	Class III
Cable	1PC rubber cable 1M H05RN-F 2x1mm square
Driver	Low voltage constant current output, excluding the AC transformer
Construction Data	
IP rating	IP67 Waterproof
IK rating	IK06
Housing	Solid Passivated (Anodizing) Aluminum CNC machined
Protection finishing	20~25µm thickness anodized film for housing. Dark grey
Trim	Whole glass
Glass	Step tempered Glass.T=6mm.
Loading capacity	300 kgs
Cable Gland	PG gland
Gasket	PMQ silicone seal
Accessories	
Mounting Sleeve	Passivated (Anodizing) Aluminum. Dark grey. Type A or B optional
Suction cap	With suction cap for pulling the lamp
Packaging	
Inner box size	150x110x85 mm
Carton size	57x32x19 cm (45PCS / carton)

CE RoHS COMPLIANT IP67 IK06

1 Year Warranty

Whole glass surface!
Two different installation possibilities with mounting sleeve A or B.

Parameter

General Data	
Item No.	UL-12W-COB-1200-D
Power	12 Watts ± 10%
LED type	1 PC 12W CREE COB LED CXA1507
Luminous flux	1000lm ± 10%
CCT	2700K, 3000K, 4000K, 6500K
CRI	80+
Beam angle	10°, 23°, 36° (100° frosted glass optional)
Dimension	Ø65x100 (mm) Diameter x Height
Cut out	Ø73mm for mounting sleeve A, Ø65mm for mounting sleeve B
Net weight	0.8 kgs
Warranty	1 year
Certifications	CE, RoHS
Electrical Data	
Input voltage	DC24V
Insulation class	Class III
Cable	1PC rubber cable 1M H05RN-F 2x1mm square
Driver	Low voltage constant current output, excluding the AC transformer
Construction Data	
IP rating	IP67 Waterproof
IK rating	IK06
Housing	Solid Passivated (Anodizing) Aluminum CNC machined
Protection finishing	20~25µm thickness anodized film for housing. Dark grey
Trim	Whole glass
Glass	Step tempered Glass.T=6mm.
Loading capacity	300 kgs
Cable Gland	PG gland
Gasket	PMQ silicone seal
Accessories	
Mounting Sleeve	Passivated (Anodizing) Aluminum. Dark grey. Type A or B optional
Suction cap	With suction cap for pulling the lamp
Packaging	
Inner box size	150x110x85 mm
Carton size	57x32x19 cm (20PCS / carton)



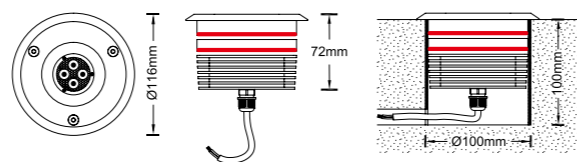
INGROUND LIGHTS SERIES

1.3 ADJUSTABLE DIRECTION GROUND SPOT SERIES

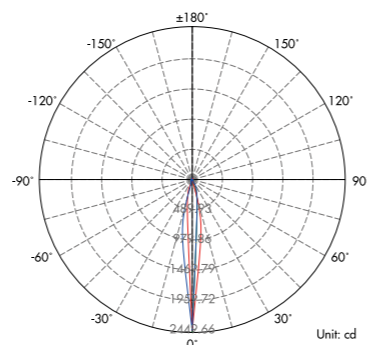




Dimension



Light Distribution Curve (3000K,60°)



Lux distance Curve (3000K,60°)

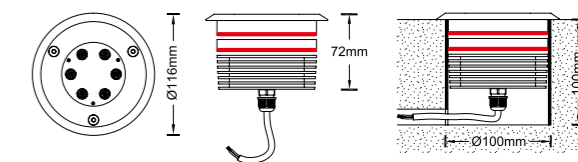
	Illuminance at a Distance	
	Center Beam LUX	Beam Width V H
2m	605.99 LUX	0.5m 0.5m
4m	151.50 LUX	1.0m 1.0m
6m	67.33 LUX	1.4m 1.5m
8m	37.87 LUX	1.9m 1.9m
10m	24.24 LUX	2.4m 2.4m
12m	16.83 LUX	2.9m 2.9m

Vert.Spread:13.8 Horiz.Spread:13.8

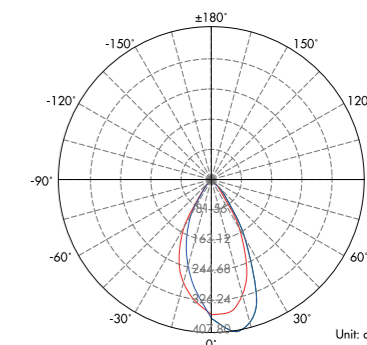
Illumination Picture (60°)



Dimension



Light Distribution Curve (3000K,40°)

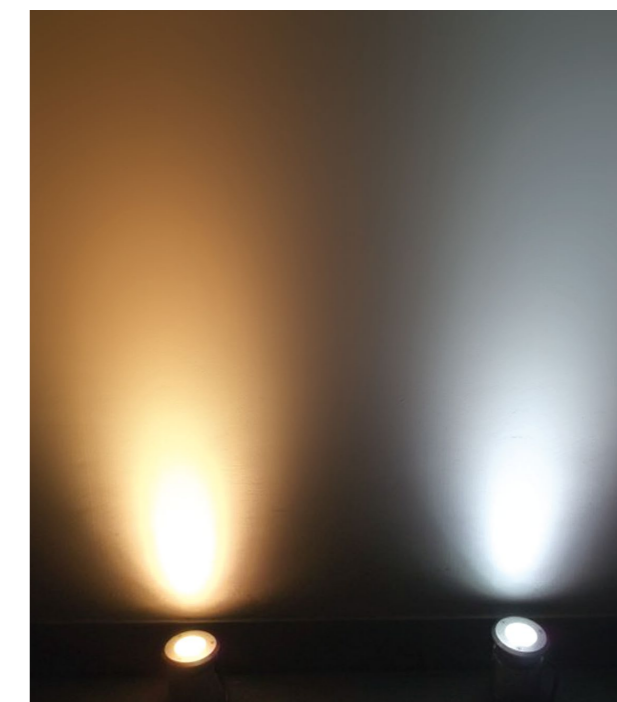


Lux distance Curve (3000K,40°)

	Illuminance at a Distance	
	Center Beam LUX	Beam Width V H
2m	89.82 LUX	1.8m 1.8m
4m	22.46 LUX	3.7m 3.5m
6m	9.98 LUX	5.5m 5.3m
8m	5.61 LUX	7.3m 7.1m
10m	3.59 LUX	9.2m 8.9m
12m	2.50 LUX	11.0m 10.6m

Vert.Spread:49.4 Horiz.Spread:47.8

Illumination Picture (40°)



CE RoHS COMPLIANT IP67 IK09

SSS 316 Passivated 1 Year Warranty Adjustable

Parameter	
General Data	
Item No.	UL4001-0400C
Power	4 Watts
LED type	4 PCS 1W OSRAM LED
Luminous flux	320~370 lm
CCT	2700K, 3000K, 4000K, 6000K, R/G/Y/B
CRI	80+
Beam angle	15°, 25°, 30°, 45°, 60° (Direction adjustable with 20° at max.)
Dimension	116x72 (mm) Diameter x Height
Cut out	100 mm
Net weight	1.221 kgs
Warranty	1 year
Certifications	CE, RoHS
Electrical Data	
Input voltage	DC24V
Insulation class	Class III
Cable	1PC rubber cable 1M H05RN-F 2x1mm square
Driver	Low voltage constant current output, excluding the transformer
Construction Data	
IP rating	IP67 Waterproof
IK rating	IK09
Housing	Solid Passivated (Anodizing) Aluminum CNC machined
Protection finishing	20~25µm thickness anodized film for housing
Trim	Stainless steel 316
Glass	Step tempered Glass. T=8mm.
Loading capacity	2000 kgs
Cable Gland	PG7 IP67
Gasket	O-ring PMQ silicone seal
Rotatable	Manual rotating bracket max 20°+20°
Accessories	
Mounting Sleeve	Passivated (Anodizing) Aluminum CNC machined
Packaging	
Inner box size	121*121*112 mm
Carton size	38*26*24 cm (12PCS / carton)

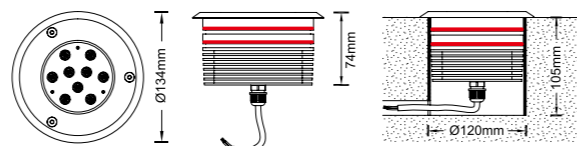
CE RoHS COMPLIANT IP67 IK09

SSS 316 Passivated 1 Year Warranty Adjustable

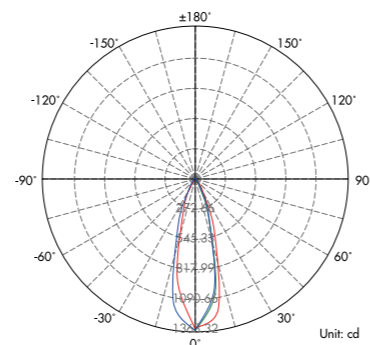
Parameter	
General Data	
Item No.	UL6001-0600C
Power	6 Watts
LED type	6 PCS 1W OSRAM LED
Luminous flux	480~540 lm
CCT	2700K, 3000K, 4000K, 6000K, R/G/Y/B
CRI	80+
Beam angle	15°, 25°, 30°, 45°, 60° (Direction adjustable with 20° at max.)
Dimension	116x72 (mm) Diameter x Height
Cut out	100 mm
Net weight	1.253 kgs
Warranty	1 year
Certifications	CE, RoHS
Electrical Data	
Input voltage	DC24V
Insulation class	Class III
Cable	1PC rubber cable 1M H05RN-F 2x1mm square
Driver	Low voltage constant current output, excluding the transformer
Construction Data	
IP rating	IP67 Waterproof
IK rating	IK09
Housing	Solid Passivated (Anodizing) Aluminum CNC machined
Protection finishing	20~25µm thickness anodized film for housing
Trim	Stainless steel 316
Glass	Step tempered Glass. T=8mm.
Loading capacity	2000 kgs
Cable Gland	PG7 IP67
Gasket	O-ring PMQ silicone seal
Rotatable	Manual rotating bracket max 20°+20°
Accessories	
Mounting Sleeve	Passivated (Anodizing) Aluminum CNC machined
Packaging	
Inner box size	121*121*112 mm
Carton size	38*26*24 cm (12PCS / carton)



Dimension



Light Distribution Curve (3000K,40°)



Lux distance Curve (3000K,40°)

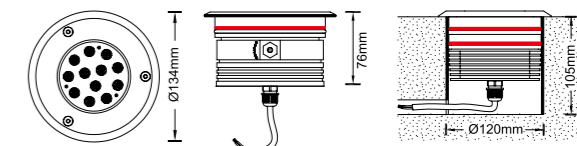
	Illuminance at a Distance	
	Center Beam LUX	Beam Width V H
2m	334.62 LUX	1.1m 1.1m
4m	83.66 LUX	2.2m 2.2m
6m	37.18 LUX	3.3m 3.4m
8m	20.91 LUX	4.4m 4.5m
10m	13.38 LUX	5.5m 5.6m
12m	9.30 LUX	6.6m 6.7m

Vert.Spread:31.0 Horiz.Spread:31.2

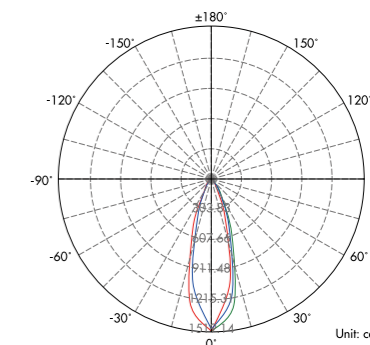
Illumination Picture (40°)



Dimension



Light Distribution Curve (3000K,40°)



Lux distance Curve (3000K,40°)

	Illuminance at a Distance	
	Center Beam LUX	Beam Width V H
2m	379.15 LUX	1.1m 1.1m
4m	94.79 LUX	2.3m 2.2m
6m	42.13 LUX	3.4m 3.3m
8m	23.70 LUX	4.5m 4.4m
10m	15.17 LUX	5.6m 5.5m
12m	10.53 LUX	6.8m 6.6m

Vert.Spread:31.6 Horiz.Spread:31.0

Illumination Picture (40°)



CE RoHS COMPLIANT IP67 IK09

SSS 316 Passivated 1 Year Warranty Adjustable

Parameter	
General Data	
Item No.	UL-9001-0900C
Power	9 Watts
LED type	9 PCS 1W OSRAM LED
Luminous flux	720~810 lm
CCT	2700K, 3000K, 4000K, 6000K, R/G/Y/B
CRI	80+
Beam angle	15°, 25°, 30°, 45°, 60° (Direction adjustable with 20° at max.)
Dimension	134x74 (mm) Diameter x Height
Cut out	120 mm
Net weight	1.221kgs
Warranty	1 year
Certifications	CE, RoHS
Electrical Data	
Input voltage	DC24V
Insulation class	Class III
Cable	1PC rubber cable 1M H05RNF 2x1mm square
Driver	Low voltage constant current output, excluding the transformer
Construction Data	
IP rating	IP67 Waterproof
IK rating	IK09
Housing	Solid Passivated (Anodizing) Aluminum CNC machined
Protection finishing	20~25µm thickness anodized film for housing
Trim	Stainless steel 316
Glass	Step tempered Glass. T=10mm.
Loading capacity	2000 kgs
Cable Gland	PG7 IP67
Gasket	O-ring PMQ silicone seal
Rotatable	Manual rotating bracket max 20°+20°
Accessories	
Mounting Sleeve	Passivated (Anodizing) Aluminum CNC machined
Packaging	
Inner box size	140*140*117 mm
Carton size	43.5*29.5*25 cm (12PCS / carton)

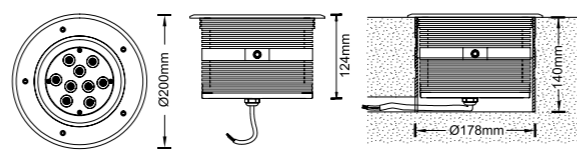
CE RoHS COMPLIANT IP67 IK09

SSS 316 Passivated 1 Year Warranty Adjustable

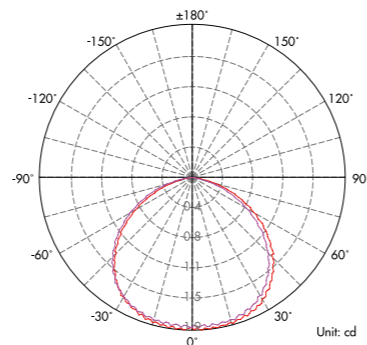
Parameter	
General Data	
Item No.	UL-1201-1200C
Power	12 Watts
LED type	12 PCS 1W OSRAM LED
Luminous flux	960~1080 lm
CCT	2700K, 3000K, 4000K, 6000K, R/G/Y/B
CRI	80+
Beam angle	15°, 25°, 30°, 45°, 60° (Direction adjustable with 30° at max.)
Dimension	134x76 (mm) Diameter x Height
Cut out	120 mm
Net weight	1.243kgs
Warranty	1 year
Certifications	CE, RoHS
Electrical Data	
Input voltage	DC24V
Insulation class	Class III
Cable	1PC rubber cable 1M H05RNF 2x1mm square
Driver	Low voltage constant current output, excluding the transformer
Construction Data	
IP rating	IP67 Waterproof
IK rating	IK09
Housing	Solid Passivated (Anodizing) Aluminum CNC machined
Protection finishing	20~25µm thickness anodized film for housing
Trim	Stainless steel 316
Glass	Step tempered Glass. T=10mm.
Loading capacity	2000 kgs
Cable Gland	PG7 IP67
Gasket	O-ring PMQ silicone seal
Rotatable	Manual rotating bracket max 20°+20°
Accessories	
Mounting Sleeve	Passivated (Anodizing) Aluminum CNC machined
Packaging	
Inner box size	140*140*117 mm
Carton size	43.5*29.5*25 cm (12PCS / carton)



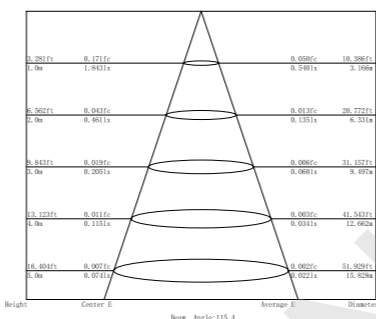
Dimension



Light Distribution Curve (3000K,40°)



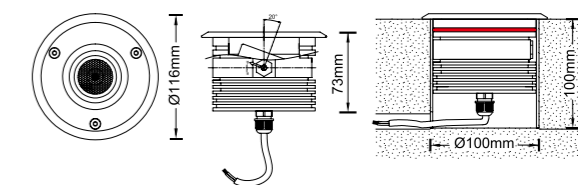
Lux distance Curve (3000K,40°)



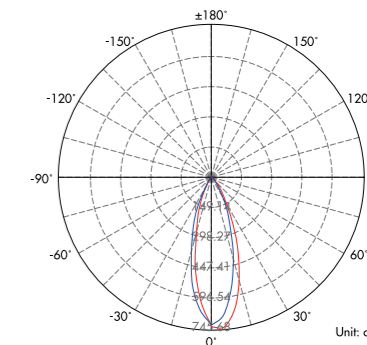
Illumination Picture (40°)



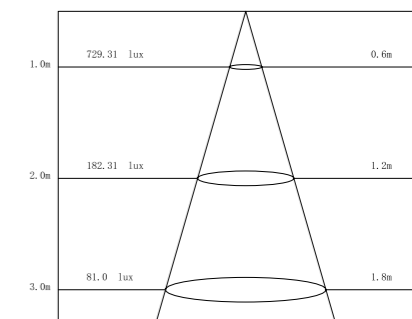
Dimension



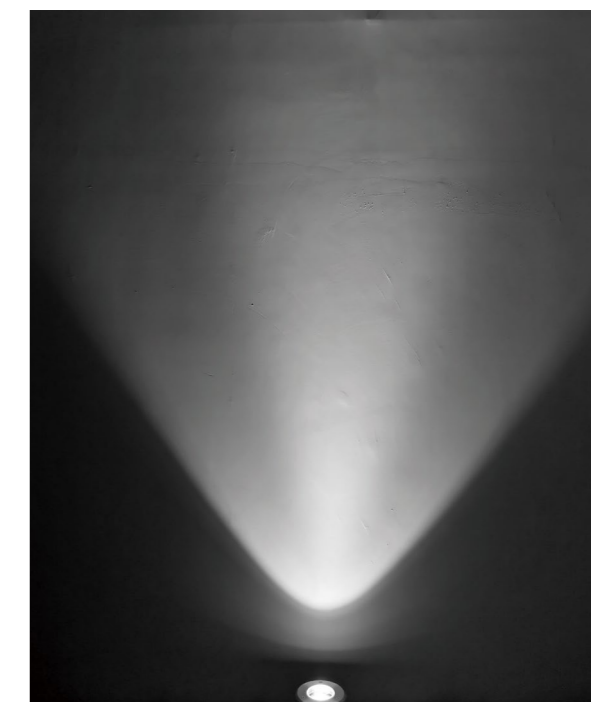
Light Distribution Curve (3000K,36°)



Lux distance Curve (3000K,36°)



Illumination Picture (36°)



CE RoHS COMPLIANT IP67 IK09

SSS 316 Passivated 1 Year Warranty Adjustable

Parameter	
General Data	
Item No.	UL-9002-1800-A
Power	1.8 Watts
LED type	9 PCS 2V CREE XPE LED
Luminous flux	1300-1350 lm
CCT	2700K, 3000K, 4000K, 6000K
CRI	80+
Beam angle	8°, 10°, 17°, 23°, 28°, 43°, 58°, 95° (beam direction adjustable by hand at 20° at max)
Dimension	Ø200x 124 (mm) Diameter x length
Cut out	178 mm
Net weight	5.1 kgs
Warranty	1 year
Certifications	CE, RoHS
Electrical Data	
Input voltage	DC24V
Insulation class	Class III
Cable	1PC rubber cable 1M H05RN-F 2x1mm square
Driver	Low voltage constant current output, excluding the transformer
Construction Data	
IP rating	IP67 Waterproof
IK rating	IK09
Housing	Solid Passivated (Anodizing) Aluminum CNC machined
Protection finishing	20~25µm thickness anodized film for housing. Dark grey
Trim	Stainless steel 316
Glass	Step tempered Glass. T=10mm.
Loading capacity	2000 kgs
Cable Gland	PG7 IP67
Gasket	O-ring PMQ silicone seal
Accessories	
Mounting Sleeve	Solid Passivated (Anodizing) Aluminum CNC machined
Packaging	
Inner box size	210*210*160mm
Carton size	44*22.5*18 cm (18PCS / carton)

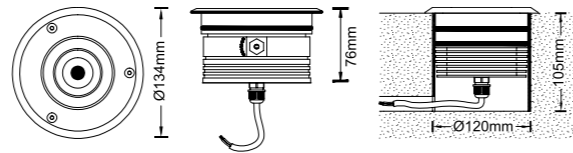
CE RoHS COMPLIANT IP67 IK09

SSS 316 Passivated 1 Year Warranty Adjustable

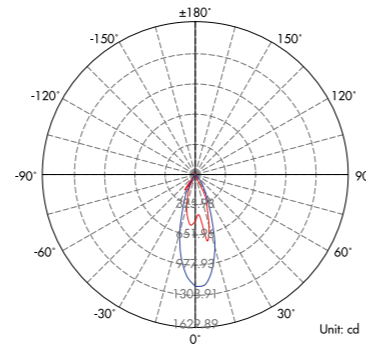
Parameter	
General Data	
Item No.	UL-6W-COB-0600-G
Power	6 Watts
LED type	1 PC 6W CREE COB LED
Luminous flux	470-500 lm
CCT	2700K, 3000K, 4000K, 6000K
CRI	80+
Beam angle	25°, 36° (beam direction adjustable by hand at 20° at max)
Dimension	Ø116x 73 (mm) Diameter x length
Cut out	100 mm
Net weight	1.38 kgs
Warranty	1 year
Certifications	CE, RoHS
Electrical Data	
Input voltage	DC24V
Insulation class	Class III
Cable	1PC rubber cable 1M H05RN-F 2x1mm square
Driver	Low voltage constant current output, excluding the transformer
Construction Data	
IP rating	IP67 Waterproof
IK rating	IK09
Housing	Solid Passivated (Anodizing) Aluminum CNC machined
Protection finishing	20~25µm thickness anodized film for housing. Dark grey
Trim	Stainless steel 316
Glass	Step tempered Glass. T=8mm.
Loading capacity	2000 kgs
Cable Gland	PG7 IP67
Gasket	O-ring PMQ silicone seal
Accessories	
Mounting Sleeve	Solid Passivated (Anodizing) Aluminum CNC machined
Packaging	
Inner box size	125*125*120 mm
Carton size	40*27*26.5 cm (12PCS / carton)



Dimension



Light Distribution Curve (3000K, 1x38°)

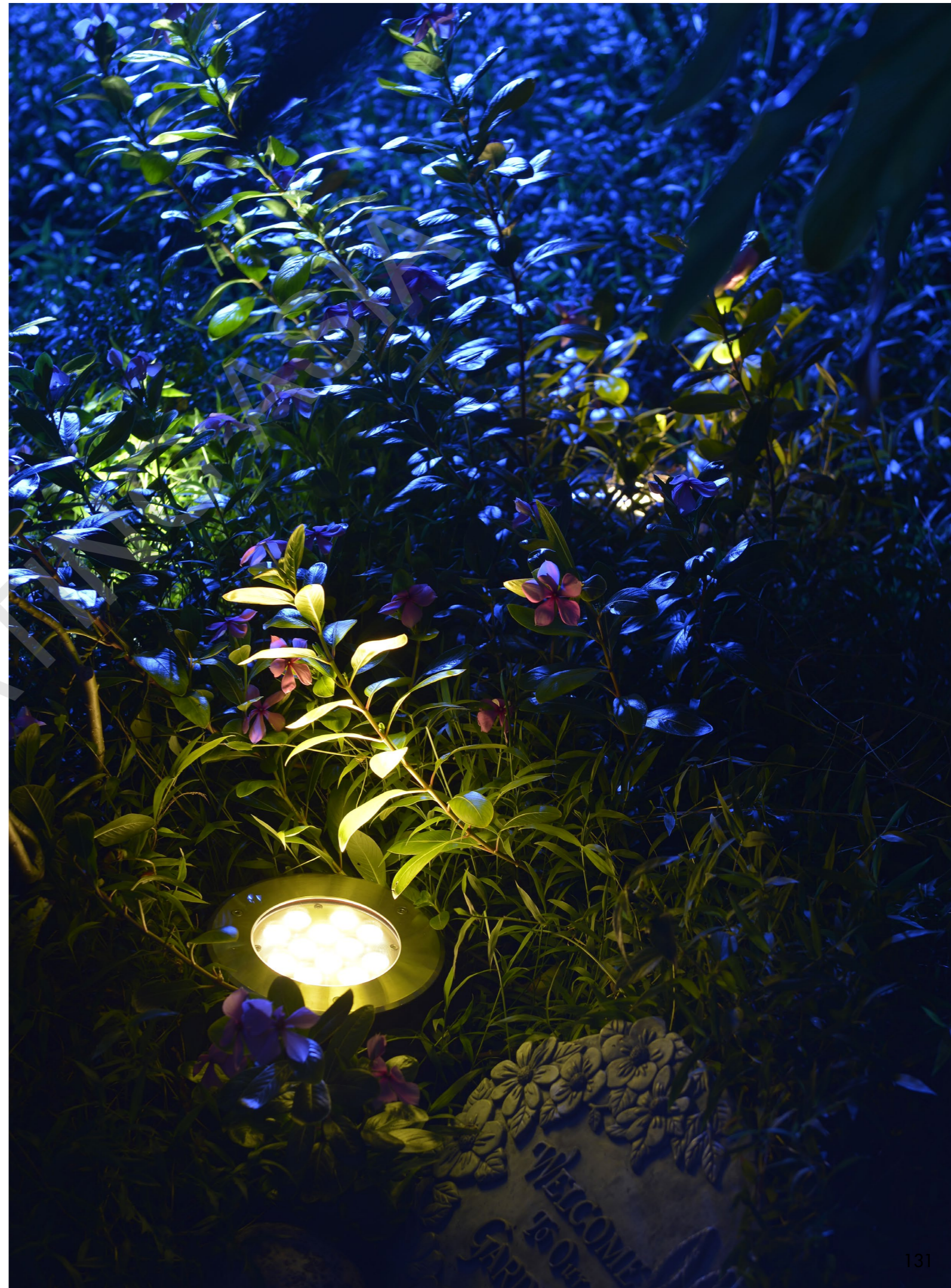


Lux distance Curve (3000K, 1x38°)

2m	124.84 LUX	0.6m	0.6m
4m	31.21 LUX	1.3m	1.1m
6m	13.87 LUX	1.9m	1.7m
8m	7.80 LUX	2.5m	2.2m
10m	4.99 LUX	3.1m	2.8m
12m	3.47 LUX	3.8m	3.3m

Vert. Spread: 17.9 Horiz. Spread: 15.8

Illumination Picture (1x38°)



CE RoHS COMPLIANT IP67 IK09

SSS 316 Passivated 1 Year Warranty

Adjustable

Parameter

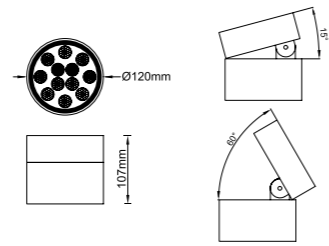
General Data	
Item No.	UL-12W-COB-1200-C
Power	12 Watts
LED type	1 PC 12W CREE COB LED
Luminous flux	950~1000 lm
CCT	2700K, 3000K, 4000K, 6000K
CRI	80+
Beam angle	24°, 38°, 60° (beam direction adjustable by hand at 20° at max)
Dimension	Ø134x 76 (mm) Diameter x length
Cut out	120 mm
Net weight	1.9 kgs
Warranty	1 year
Certifications	CE, RoHS
Electrical Data	
Input voltage	DC24V
Insulation class	Class III
Cable	1PC rubber cable 1M H05RN-F 2x1mm square
Driver	Low voltage constant current output, excluding the transformer
Construction Data	
IP rating	IP67 Waterproof
IK rating	IK09
Housing	Solid Passivated (Anodizing) Aluminum CNC machined
Protection finishing	20~25µm thickness anodized film for housing. Dark grey
Trim	Stainless steel 316
Glass	Step tempered Glass. T=8mm.
Loading capacity	2000 kgs
Cable Gland	PG7 IP67
Gasket	O-ring PMQ silicone seal
Accessories	
Mounting Sleeve	Passivated (Anodizing) Aluminum CNC machined
Packaging	
Inner box size	140*140*117 mm
Carton size	43.5*16.5*25 cm (6PCS / carton)



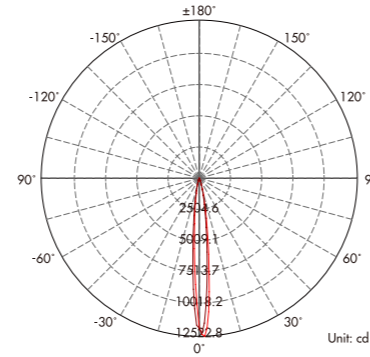
Trans 15W



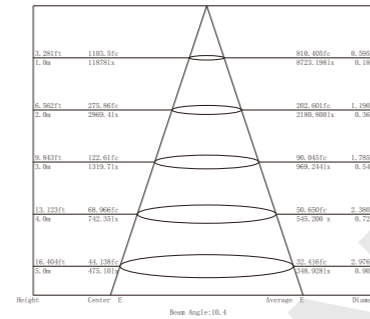
Dimension



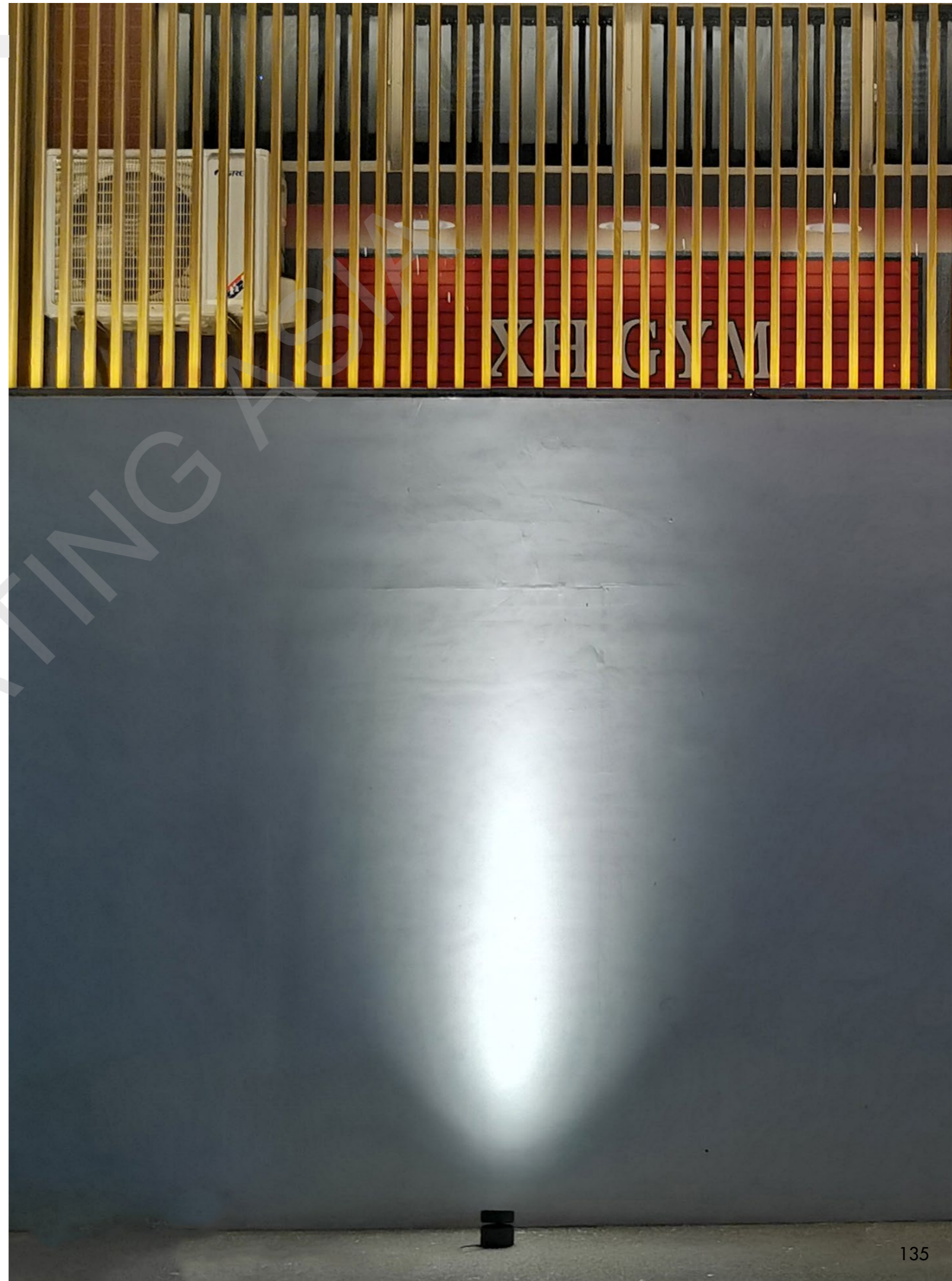
Light Distribution Curve (3000K, 10°)



Lux distance Curve (3000K, 10°)



Illumination Picture (10°)



CE RoHS COMPLIANT IP67 IK06

Passivated Patent 1 Year Warranty

UGR<5 when 10°

Parameter

General Data	
Item No.	UL-1205-1500AH
Power	1.5 Watts +10%
LED type	12 PCS OSRAM 3030 LED
Luminous flux	800 lm +10%
CCT	2700K, 3000K, 4000K, 4500K, 5700K, 6500K
CRI	80+
Beam angle	5°, 10°, 17°, 23°, 28°, 43°, 58°, 95° (Beam direction adjustable -15° to 60°)
Dimension	Ø120x107 (mm) Diameter x length
Cut out	/ mm
Net weight	2.75 kgs
Warranty	1 year
Certifications	CE, RoHS
Electrical Data	
Input voltage	AC 100-265V
Insulation class	Class I
Cable	1PC rubber cable 1m H05RN-F 3 x 1mm square
Driver	builtin constant current driver
Construction Data	
IP rating	IP67 Waterproof
IK rating	IK06
Housing	Solid Passivated (Anodizing) Aluminum CNC machined
Protection finishing	Anodized +Powder coated painting in dark grey
Trim	Aluminium
Glass	Tempered Glass
Loading capacity	/
Cable Gland	PG gland
Gasket	silicone ring + silicone glue seal
Accessories	
Spike	With spike for earth mounted
Round base part	With round base part and screws for ground surface mounted
Packaging	
Inner box size	140*140*135 mm
Carton size	30*30*29 cm (4 PCS/carton)



INGROUND LIGHTS SERIES

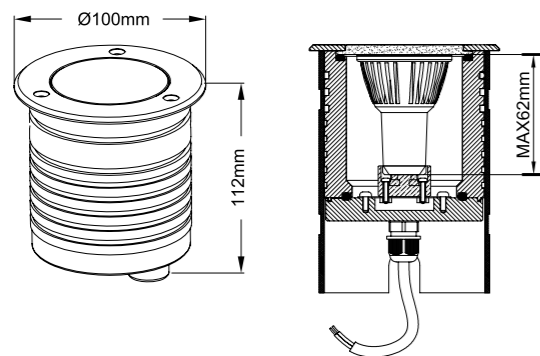
1.4 GU10 /MR16 GROUND SPOT SERIES





Parameter	
General Data	
Item No.	UL-GU10-A
Power	(For fitting lamps GU10 with 65mm at max(pins length included))
LED type	Without lamp as standard, (with lamp as options)
Luminous flux	/
CCT	/
CRI	/
Beam angle	/
Dimension	Ø100x112 (mm) Diameter x Height
Cut out	88 mm
Net weight	1.010 kgs
Warranty	1 year
Certifications	CE, RoHS
Electrical Data	
Input voltage	AC100~245V
Insulation class	Class I
Cable	1PC rubber cable 1M H05RN-F 3x1mm square
Driver	/
Construction Data	
IP rating	IP67 Waterproof
IK rating	IK07
Housing	Solid Passivated (Anodizing) Aluminum CNC machined
Protection finishing	20~25µm thickness anodized film for housing. Dark grey
Trim	Stainless steel 316
Glass	Step tempered Glass. T=6mm.
Loading capacity	610 kgs
Cable Gland	PG7 IP67
Gasket	O-ring PMQ silicone seal
Accessories	
Mounting Sleeve	Anti-corrosion PVC. Grey
Packaging	
Inner box size	115*115*145 mm
Carton size	48.5*25*31.5 cm (16PCS / carton)

Dimension

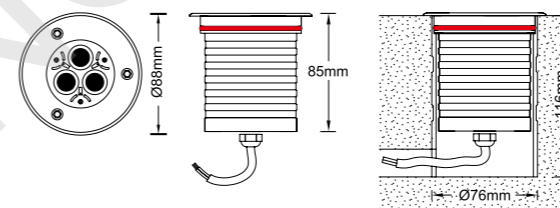


Application Picture



Parameter	
General Data	
Item No.	UL-GU10-C
Power	(For fitting lamps GU10 with 65mm at max(pins length included))
LED type	Without lamp as standard, (with lamp as options)
Luminous flux	/
CCT	/
CRI	/
Beam angle	/
Dimension	Ø88x85 (mm) Diameter x Height
Cut out	76 mm
Net weight	0.72 kgs
Warranty	3 years
Certifications	CE, RoHS
Electrical Data	
Input voltage	AC100~245V
Insulation class	Class I
Cable	1PC rubber cable 1M H05RN-F 3x1mm square
Driver	/
Construction Data	
IP rating	IP67 Waterproof
IK rating	IK07
Housing	Solid Passivated (Anodizing) Aluminum CNC machined
Protection finishing	20~25µm thickness anodized film for housing. Dark grey
Trim	Stainless steel 316
Glass	Step tempered Glass. T=6mm.
Loading capacity	610 kgs
Cable Gland	PG7 IP67
Gasket	O-ring PMQ silicone seal
Accessories	
Mounting Sleeve	Anti-corrosion PVC. Grey
Packaging	
Inner box size	95*95*132 mm
Carton size	40.5*40.5*28 cm (32PCS / carton)

Dimension



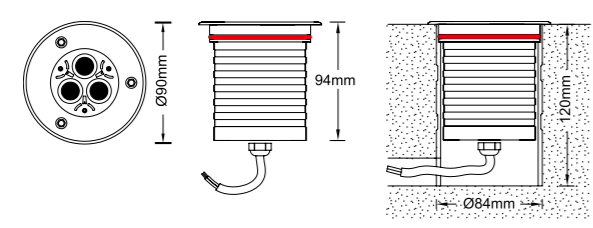
Application Picture





Parameter	
General Data	
Item No.	UL-GU10-C
Power	(For fitting lamps GU10 with 55mm at max(pins length included))
LED type	Without lamp as standard, (with lamp as options)
Luminous flux	/
CCT	/
CRI	/
Beam angle	(Direction adjustable by hand with 20° at max.)
Dimension	Ø90 x 94 (mm) Diameter x Height
Cut out	84 mm
Net weight	0.74 kgs
Warranty	1 year
Certifications	CE, RoHS
Electrical Data	
Input voltage	AC100~245V
Insulation class	Class I
Cable	1PC rubber cable 1M H05RN-F 3x1mm square
Driver	/
Construction Data	
IP rating	IP67 Waterproof
IK rating	IK07
Housing	Solid Passivated (Anodizing) Aluminum CNC machined
Protection finishing	20~25µm thickness anodized film for housing. Dark grey
Trim	Stainless steel 316
Glass	Step tempered Glass. T=6mm.
Loading capacity	610 kgs
Cable Gland	PG7 IP67
Gasket	O-ring PMQ silicone seal
Accessories	
Mounting Sleeve	Passivated (Anodizing) Aluminum CNC machined.
Packaging	
Inner box size	95*95*132 mm
Carton size	40.5*40.5*28 cm (32PCS / carton)

Dimension



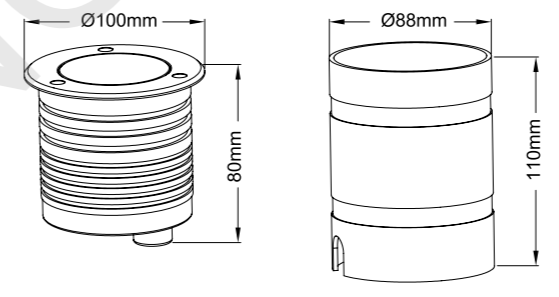
IP67 IK07
SSS 316 **Passivated** **1 Year Warranty**

Application Picture



Parameter	
General Data	
Item No.	UL-MR16-A
Power	(For fitting lamps GU10 with 60mm at max(pins length included))
LED type	Without lamp as standard, (with lamp as options)
Luminous flux	/
CCT	/
CRI	/
Beam angle	/
Dimension	100x80 (mm) (Diameter x Height)
Cut out	90 mm
Net weight	0.945 kgs
Warranty	1 year
Certifications	CE, RoHS
Electrical Data	
Input voltage	DC 12V
Insulation class	Class III
Cable	1PC rubber cable 1M H05RN-F 2x1mm square
Driver	/
Construction Data	
IP rating	IP67 Waterproof
IK rating	IK07
Housing	Solid Passivated (Anodizing) Aluminum CNC machined
Protection finishing	20~25µm thickness anodized film for housing. Dark grey
Trim	Stainless steel 316
Glass	Step tempered Glass. T=6mm.
Loading capacity	610 kgs
Cable Gland	PG7 IP67
Gasket	O-ring PMQ silicone seal
Accessories	
Mounting Sleeve	Passivated (Anodizing) Aluminum CNC machined. Dark grey
Packaging	
Inner box size	113*113*132 mm
Carton size	47*24.5*28 cm (16PCS / carton)

Dimension



IP67 IK07
SSS 316 **Passivated** **1 Year Warranty**

Application Picture



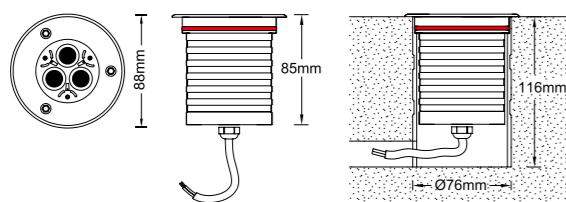
INGROUND LIGHTS SERIES

INGROUND LIGHTS SERIES



Parameter	
General Data	
Item No.	UL-MR16-LC
Power	(For fitting lamps GU10 with 65mm at max(pins length included))
LED type	Without lamp as standard, (with lamp as options)
Luminous flux	/
CCT	/
CRI	/
Beam angle	/
Dimension	Ø88x85 (mm) Diameter x Height
Cut out	76 mm
Net weight	0.72 kgs
Warranty	1 year
Certifications	CE, RoHS
Electrical Data	
Input voltage	DC 12 V
Insulation class	Class III
Cable	1PC rubber cable 1M H05RN-F 2x1mm square
Driver	/
Construction Data	
IP rating	IP67 Waterproof
IK rating	IK07
Housing	Solid Passivated (Anodizing) Aluminum CNC machined
Protection finishing	20~25µm thickness anodized film for housing. Dark grey
Trim	Stainless steel 316
Glass	Step tempered Glass. T=6mm.
Loading capacity	610 kgs
Cable Gland	PG7 IP67
Gasket	O-ring PMQ silicone seal
Accessories	
Mounting Sleeve	Anti-corrosion PVC. Grey
Packaging	
Inner box size	95*95*132 mm
Carton size	40.5*40.5*28 cm (32PCS / carton)

Dimension

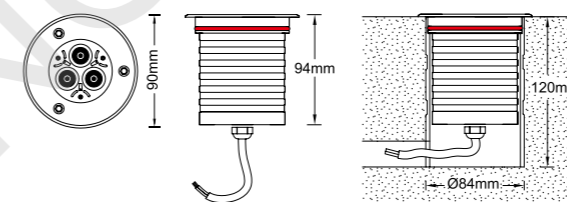


Application Picture



Parameter	
General Data	
Item No.	UL-MR16-C
Power	(For fitting lamps GU10 with 50mm at max (pins length included))
LED type	Without lamp as standard, (with lamp as options)
Luminous flux	/
CCT	/
CRI	/
Beam angle	/ (Direction adjustable by hand with 20° at max)
Dimension	Ø90x94 (mm) Diameter x Height
Cut out	84 mm
Net weight	0.74 kgs
Warranty	1 year
Certifications	CE, RoHS
Electrical Data	
Input voltage	DC 12V
Insulation class	Class III
Cable	1PC rubber cable 1M H05RN-F 2x1mm square
Driver	/
Construction Data	
IP rating	IP67 Waterproof
IK rating	IK07
Housing	Solid Passivated (Anodizing) Aluminum CNC machined
Protection finishing	20~25µm thickness anodized film for housing. Dark grey
Trim	Stainless steel 316
Glass	Step tempered Glass. T=6mm.
Loading capacity	610 kgs
Cable Gland	PG7 IP67
Gasket	O-ring PMQ silicone seal
Accessories	
Mounting Sleeve	Passivated (Anodizing) Aluminium
Packaging	
Inner box size	95*95*132 mm
Carton size	40.5*40.5*28 cm (32PCS / carton)

Dimension

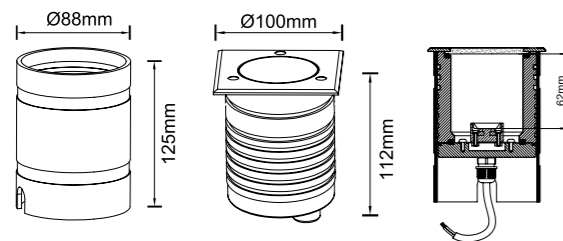


Application Picture





Dimension



Parameter	
General Data	
Item No.	UL-GU10-A-S
Power	(For fitting lamps GU10 with 65mm at max(pins length included))
LED type	Without lamp as standard, (with lamp as options)
Luminous flux	/
CCT	/
CRI	/
Beam angle	/
Dimension	Ø100x100x112 mm (L x W x H)
Cut out	88 mm
Net weight	1.2 kgs
Warranty	1 year
Certifications	CE, RoHS
Electrical Data	
Input voltage	AC100~245V
Insulation class	Class I
Cable	1PC rubber cable 1M H05RN-F 3x1mm square
Driver	/
Construction Data	
IP rating	IP67 Waterproof
IK rating	IK07
Housing	Solid Passivated (Anodizing) Aluminum CNC machined
Protection finishing	20~25µm thickness anodized film for housing. Dark grey
Trim	Stainless steel 316
Glass	Step tempered Glass. T=6mm.
Loading capacity	610 kgs
Cable Gland	PG7 IP67
Gasket	O-ring PMQ silicone seal
Accessories	
Mounting Sleeve	Anti-corrosion PVC. Grey
Packaging	
Inner box size	115*115*145 mm
Carton size	48.5*25*31.5 cm (16PCS / carton)

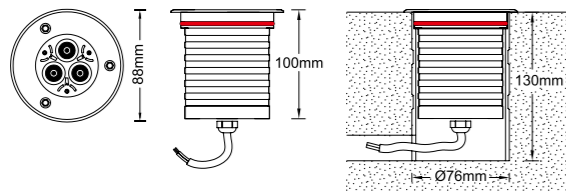


Application Picture





Dimension



Parameter	
General Data	
Item No.	UL-GU10-D
Power	(For fitting lamps GU10 with 50~70mm at max(pins length included)) With spring inside up-down design.
LED type	Without lamp as standard, (with lamp as options)
Luminous flux	/
CCT	/
CRI	/
Beam angle	/
Dimension	Ø88x100 (mm) Diameter x Height
Cut out	76 mm
Net weight	0.80 kgs
Warranty	1 year
Certifications	CE, RoHS
Electrical Data	
Input voltage	AC100~245V
Insulation class	Class I
Cable	1PC rubber cable 1M H05RN-F 3x1mm square
Driver	/
Construction Data	
IP rating	IP67 Waterproof
IK rating	IK07
Housing	Solid Passivated (Anodizing) Aluminum CNC machined
Protection finishing	20~25µm thickness anodized film for housing. Dark grey
Trim	Stainless steel 316
Glass	Step tempered Glass. T=6mm.
Loading capacity	610 kgs
Cable Gland	PG7 IP67
Gasket	O-ring PMQ silicone seal
Accessories	
Mounting Sleeve	Anti-corrosion PVC. Grey
Packaging	
Inner box size	95*95*132 mm
Carton size	50*40*15.5 cm (20PCS / carton)



IP67 IK07
SSS 316 **Passivated** **1 Year Warranty**

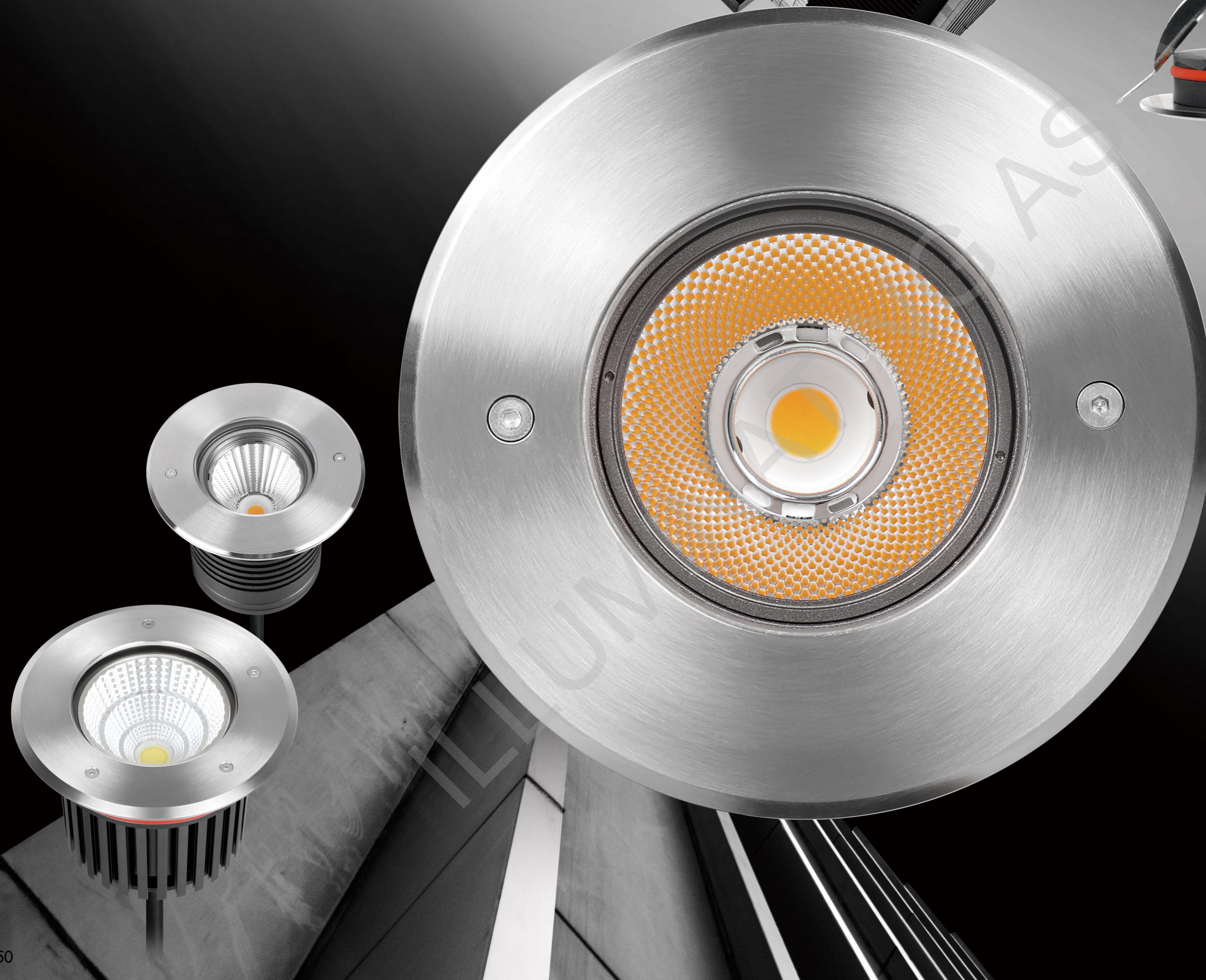
Up-Down Spring!

Application Picture



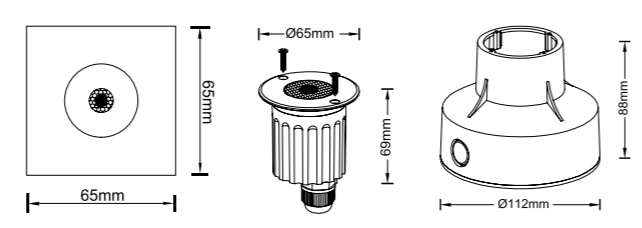
INGROUND LIGHTS SERIES

1.5 COB LED GROUND SPOT SERIES

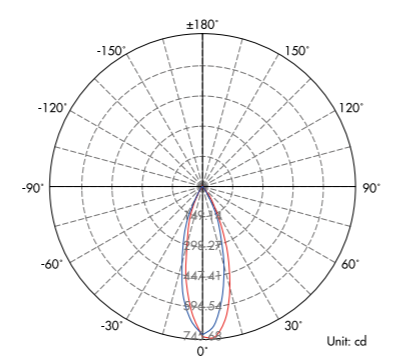




Dimension



Light Distribution Curve (3000K, 36° COB reflector)



Lux distance Curve (3000K, 36° COB reflector)

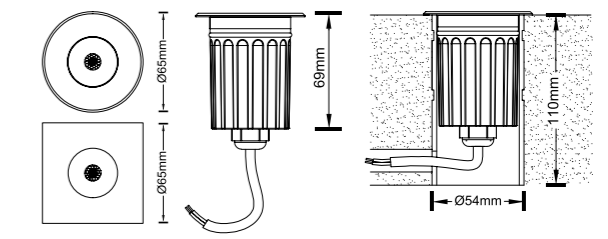
	Illuminance at a Distance	
	Center Beam LUX	Beam Width V H
2m	182.33 LUX	1.2m 1.2m
4m	45.58 LUX	2.3m 2.4m
6m	20.26 LUX	3.5m 3.6m
8m	11.40 LUX	4.7m 4.8m
10m	7.29 LUX	5.8m 6.0m
12m	5.06 LUX	7.0m 7.2m

Vert.Spread:32.5 Horiz.Spread:33.2

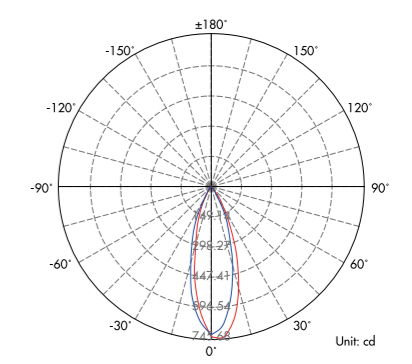
Illumination Picture (36° COB reflector)



Dimension



Light Distribution Curve (3000K, 36° COB reflector)



Lux distance Curve (3000K, 36° COB reflector)

	Illuminance at a Distance	
	Center Beam LUX	Beam Width V H
2m	182.33 LUX	1.2m 1.2m
4m	45.58 LUX	2.3m 2.4m
6m	20.26 LUX	3.5m 3.6m
8m	11.40 LUX	4.7m 4.8m
10m	7.29 LUX	5.8m 6.0m
12m	5.06 LUX	7.0m 7.2m

Vert.Spread:32.5 Horiz.Spread:33.2

Illumination Picture (36° COB reflector)



CE RoHS COMPLIANT IP67 IK08
SSS 316 1 Year Warranty

Round trim as standard (square trim optional)
COB reflector as standard (COB lens optional)

Parameter	
General Data	
Item No.	Round trim: UL-6W-COB-0600-B Square trim: UL-6W-COB-0600-B-S
Power	6 Watts +10%
LED type	1 PC 6W CREE COB LED
Luminous flux	470-500 lm +10%
CCT	2700K, 3000K, 4000K, 6000K
CRI	80+
Beam angle	COB reflector 24°, 36° as standard (Optional COB lens 15°, 23°, 36°)
Dimension	Ø65x69 (mm) Diameter x length
Cut out	112 mm
Net weight	0.45 kgs
Warranty	1 year
Certifications	CE, RoHS
Electrical Data	
Input voltage	DC24V
Insulation class	Class III
Cable	1PC rubber cable 1M H05RN-F 2 x 1mm square
Driver	Low voltage constant current output, excluding the transformer
Construction Data	
IP rating	IP67 Waterproof
IK rating	IK08
Housing	Solid Passivated (Anodizing) Aluminum CNC machined
Protection finishing	20-25µm thickness anodized film for housing, silver color as standard, dark grey optional
Trim	Round trim as standard (Square trim optional) Stainless steel 316
Glass	Step tempered Glass. T=6mm
Loading capacity	500 kgs
Cable Gland	PG gland
Gasket	O-ring PMQ silicone seal
Accessories	
Mounting Sleeve	Anti-corrosion grey PVC
Honeycomb	with honeycomb as optional
Packaging	
Inner box size	117*117*105 mm
Carton size	61*25*24cm (20PCS / carton)

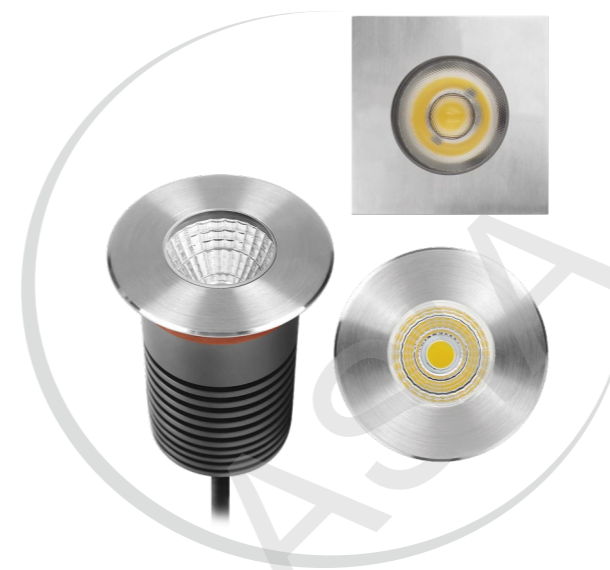
CE RoHS COMPLIANT IP67 IK08
SSS 316 1 Year Warranty

Round trim as standard (square trim optional)
COB reflector as standard (COB lens optional)

Parameter	
General Data	
Item No.	Round trim: UL-6W-COB-0600-F Square trim: UL-6W-COB-0600-F-S
Power	6 Watts +10%
LED type	1 PC 6W CREE COB LED
Luminous flux	470-500 lm +10%
CCT	2700K, 3000K, 4000K, 6000K
CRI	80+
Beam angle	COB reflector 24°, 36° as standard (Optional COB lens 15°, 23°, 36°)
Dimension	Ø65x69 (mm) Diameter x length
Cut out	54 mm
Net weight	0.45 kgs
Warranty	1 year
Certifications	CE, RoHS
Electrical Data	
Input voltage	DC24V
Insulation class	Class III
Cable	1PC rubber cable 1M H05RN-F 2 x 1mm square
Driver	Low voltage constant current output, excluding the transformer
Construction Data	
IP rating	IP67 Waterproof
IK rating	IK08
Housing	Solid Passivated (Anodizing) Aluminum CNC machined
Protection finishing	20-25µm thickness anodized film for housing, silver color as standard, dark grey optional
Trim	Round trim as standard (Square trim optional) Stainless steel 316
Glass	Step tempered Glass. T=6mm
Loading capacity	500 kgs
Cable Gland	PG gland
Gasket	O-ring PMQ silicone seal
Accessories	
Mounting Sleeve	Passivated (Anodizing) Aluminum CNC machined. Dark grey
Honeycomb	with honeycomb as optional
Packaging	
Inner box size	85*85*120 mm
Carton size	45*36*14 cm (20 PCS / carton)

INGROUND LIGHTS SERIES

INGROUND LIGHTS SERIES



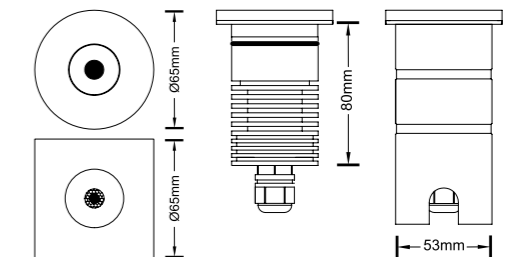
CE RoHS COMPLIANT IP67 IK08

SSS 316 1 Year Warranty

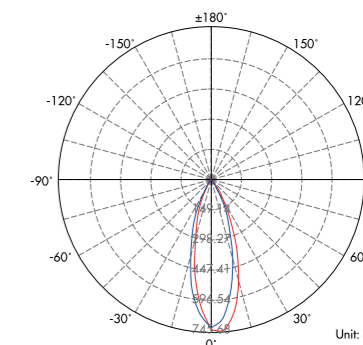
Round trim as standard (square trim optional)
COB reflector as standard (COB lens optional)

Parameter	
General Data	
Item No.	Round trim: UL-6V-COB-0600-CH Square trim: UL-6V-COB-0600-CH-S
Power	6 Watts +10%
LED type	1 PC 6W CREE COB LED
Luminous flux	470-500 lm +10%
CCT	2700K, 3000K, 4000K, 6000K
CRI	80+
Beam angle	COB reflector 24°, 36° as standard (Optional COB lens 15°, 23°, 36°)
Dimension	Ø65x80 (mm) Diameter x length
Cut out	53 mm
Net weight	0.59 kgs
Warranty	1 year
Certifications	CE, RoHS
Electrical Data	
Input voltage	AC100~245V
Insulation class	Class I
Cable	1PC rubber cable 1M H05RN-F 3 x 1 mm square
Driver	Built-in high voltage constant current driver with transformer
Construction Data	
IP rating	IP67 Waterproof
IK rating	IK08
Housing	Solid Passivated (Anodizing) Aluminum CNC machined
Protection finishing	20~25µm thickness anodized film for housing, silver color as standard, dark grey optional
Trim	Round trim as standard (Square trim optional) Stainless steel 316
Glass	Step tempered Glass. T=6mm
Loading capacity	500 kgs
Cable Gland	PG gland
Gasket	O-ring PMQ silicone seal
Accessories	
Mounting Sleeve	Passivated (Anodizing) Aluminum CNC machined. Dark grey with honeycomb as optional
Packaging	
Inner box size	85*85*120 mm
Carton size	45*36*14 cm (20 PCS / carton)

Dimension



Light Distribution Curve (3000K, 36° COB reflector)

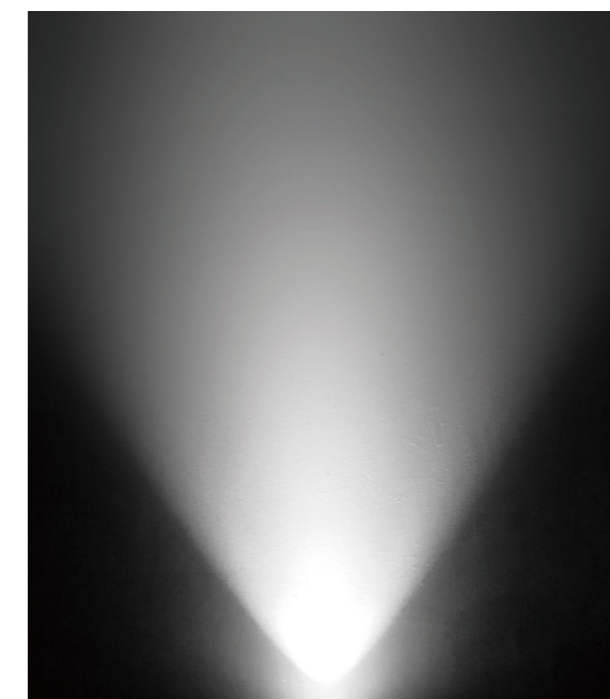


Lux distance Curve (3000K, 36° COB reflector)

Center Beam LUX	Beam Width	
	V	H
182.33 LUX	1.2m	1.2m
45.58 LUX	2.3m	2.4m
20.26 LUX	3.5m	3.6m
11.40 LUX	4.7m	4.8m
7.29 LUX	5.8m	6.0m
5.06 LUX	7.0m	7.2m

Vert.Spread:32.5 Horiz.Spread:33.2

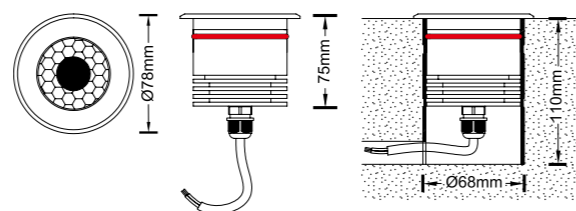
Illumination Picture (36° COB reflector)



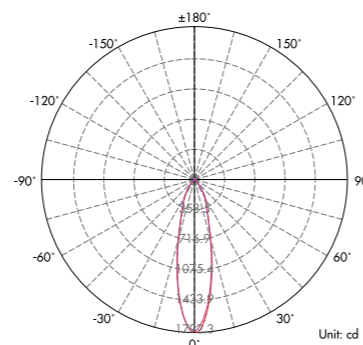
INGROUND LIGHTS SERIES



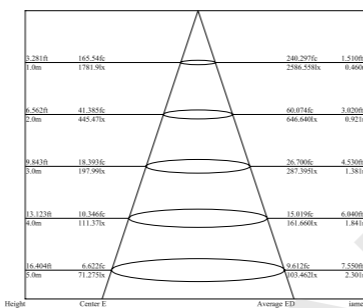
Dimension



Light Distribution Curve (3000K, 1x38°)



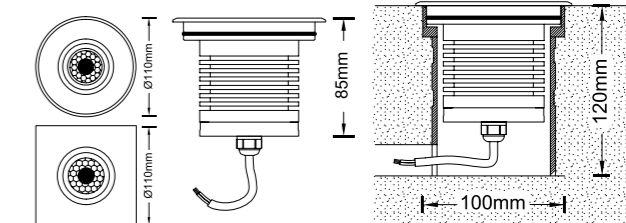
Lux distance Curve (3000K, 1x38°)



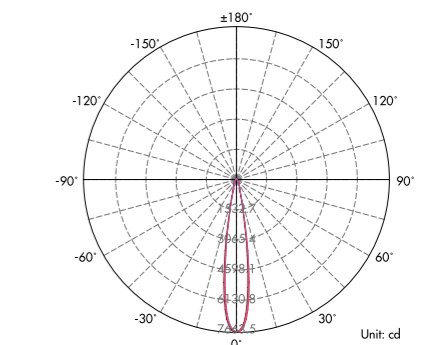
Illumination Picture (1x38°)



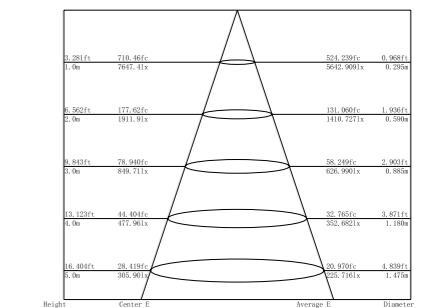
Dimension



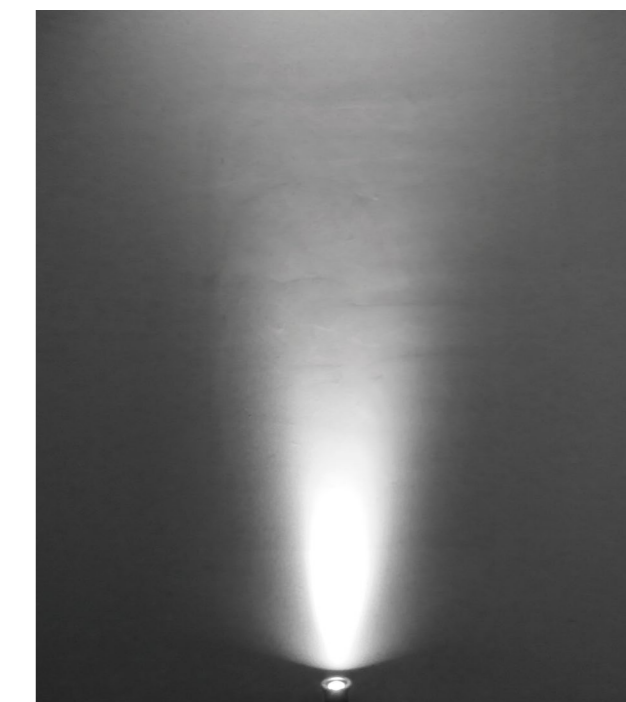
Light Distribution Curve (3000K, 10° COB lens)



Lux distance Curve (3000K, 10° COB lens)



Illumination Picture (10° COB lens)



CE RoHS COMPLIANT IP67 IK09

SSS 316 1 Year Warranty

Round trim as standard (square trim optional)
COB reflector as standard (COB lens optional)

Parameter

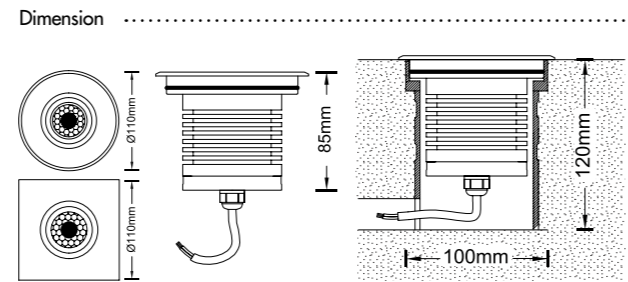
General Data	
Item No.	Round trim: UL-12W-COB-1200-AH Square trim: UL-12W-COB-1200-AHS
Power	12 Watts +10%
LED type	1 PC 12W CREE COB LED
Luminous flux	1050-1100lm +10%
CCT	2700K, 3000K, 4000K, 6000K
CRI	80+
Beam angle	COB reflector 15°, 23°, 38°, 45°, 60° as standard (Optional COB lens 10°, 23°, 36°)
Dimension	Ø110x85(mm) Diameter x length
Cut out	100 mm
Net weight	1.74 kgs
Warranty	1 year
Certifications	CE, RoHS
Electrical Data	
Input voltage	AC95~265V (or DC24V optional)
Insulation class	Class I
Cable	1PC rubber cable 1M H05RNF 3 x 1mm square
Driver	Built-in high voltage constant current driver with transformer
Construction Data	
IP rating	IP67 Waterproof
IK rating	IK09
Housing	Solid Passivated (Anodizing) Aluminum CNC machined
Protection finishing	20~25µm thickness anodized film for housing, silver color as standard, dark grey optional.
Trim	Round trim as standard (Square trim optional) Stainless steel 316
Glass	Step tempered Glass. T=10mm
Loading capacity	2000 kgs
Cable Gland	PG gland
Gasket	O-ring PMQ silicone seal
Accessories	
Mounting Sleeve	Anti-corrosion grey PVC+dark grey Aluminium ring
Honeycomb	with honeycomb as optional
Packaging	
Inner box size	150*150*155 mm
Carton size	47.5*32*33.5 cm (12 PCS / carton)

CE RoHS COMPLIANT IP67 IK08

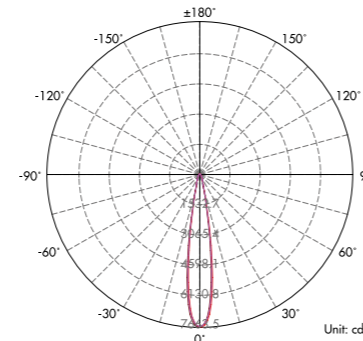
SSS 316 Passivated 1 Year Warranty

Parameter

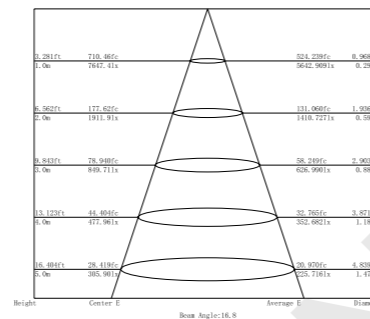
General Data	
Item No.	UL-9W-COB-0900-B
Power	9 Watts
LED type	1 PC 9W CREE COB LED
Luminous flux	700-750 lm
CCT	2700K, 3000K, 4000K, 6000K
CRI	80+
Beam angle	10°, 23°, 38°
Dimension	Ø78x75 (mm) Diameter x length
Cut out	68 mm
Net weight	0.538 kgs
Warranty	1 year
Certifications	CE, RoHS
Electrical Data	
Input voltage	DC24V as standard, (AC100~245V as options)
Insulation class	Class III
Cable	1PC rubber cable 1M H05RNF 2x1mm square
Driver	Low voltage constant current output, excluding the transformer
Construction Data	
IP rating	IP67 Waterproof
IK rating	IK08
Housing	Solid Passivated (Anodizing) Aluminum CNC machined
Protection finishing	20~25µm thickness anodized film for housing, Dark grey
Trim	Stainless steel 316
Glass	Step tempered Glass. T=8mm.
Loading capacity	2000 kgs
Cable Gland	PG7 IP67
Gasket	O-ring PMQ silicone seal
Accessories	
Mounting Sleeve	Passivated (Anodizing) Aluminum CNC machined, Dark grey
Honeycomb	with honeycomb as optional
Packaging	
Inner box size	85*85*120mm
Carton size	45*36*14cm (20PCS/carton)



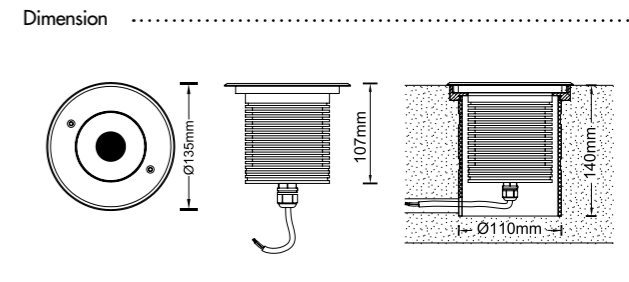
Light Distribution Curve (3000K, 10° COB lens)



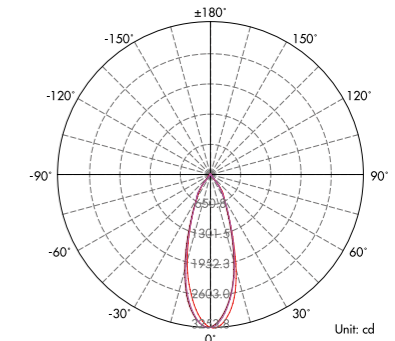
Lux distance Curve (3000K, 10° COB lens)



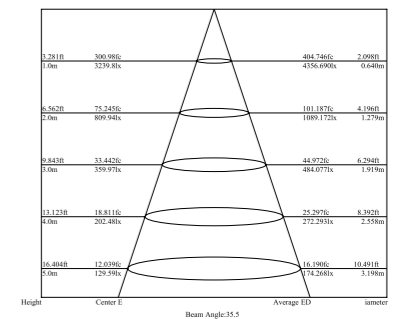
Illumination Picture (10° COB lens)



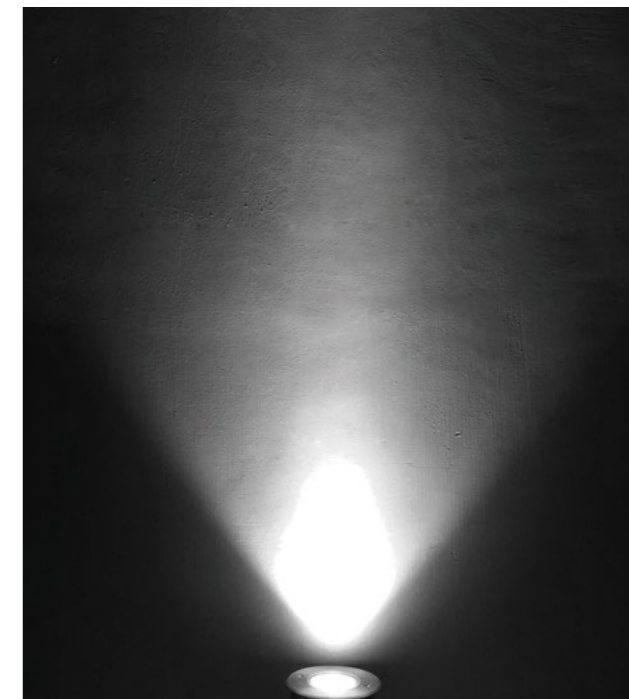
Light Distribution Curve (3000K, 1x38°)



Lux distance Curve (3000K, 1x38°)



Illumination Picture (1x38°)



CE RoHS COMPLIANT IP67 IK09

SSS 316 1 Year Warranty

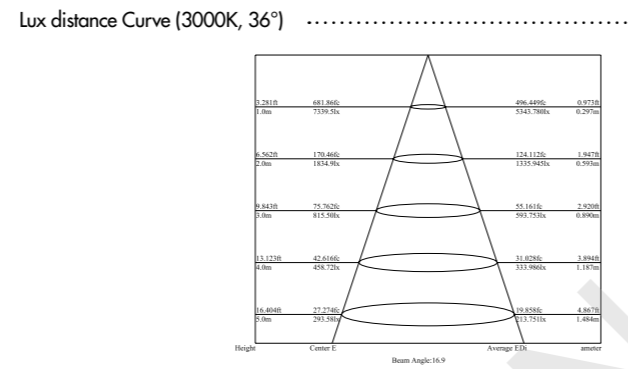
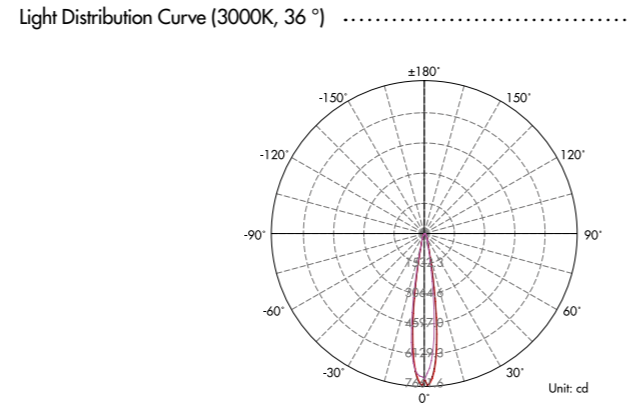
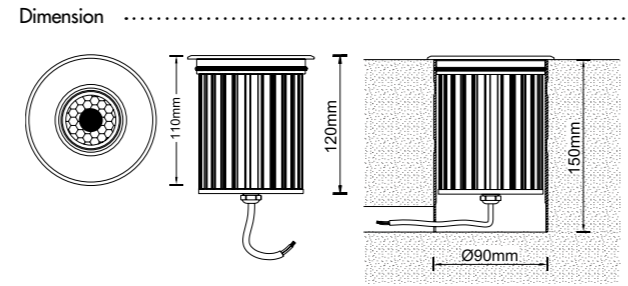
Round trim as standard (square trim optional)
COB reflector as standard (COB lens optional)

Parameter	
General Data	
Item No.	Round trim: UL-15W-COB-1500-AH Square trim: UL-15W-COB-1500-AHS
Power	1.5 Watts +10%
LED type	1 PC 15W CREE COB LED
Luminous flux	1320~1450lm +10%
CCT	2700K, 3000K, 4000K, 6000K
CRI	80+
Beam angle	COB reflector 15°, 23°, 38°, 45°, 60° as standard (Optional COB lens 10°, 23°, 36°)
Dimension	Ø110x85(mm) Diameter x length
Cut out	100 mm
Net weight	1.74 kgs
Warranty	1 year
Certifications	CE, RoHS
Electrical Data	
Input voltage	AC95~265V (or DC24V optional)
Insulation class	Class I
Cable	1PC rubber cable 1M H05RN-F 3 x 1mm square
Driver	Built-in high voltage constant current driver with transformer
Construction Data	
IP rating	IP67 Waterproof
IK rating	IK09
Housing	Solid Passivated (Anodizing) Aluminum CNC machined
Protection finishing	20~25µm thickness anodized film for housing, silver color as standard, dark grey optional.
Trim	Round trim as standard (Square trim optional) Stainless steel 316
Glass	Step tempered Glass. T=10mm
Loading capacity	2000 kgs
Cable Gland	PG gland
Gasket	O-ring PMQ silicone seal
Accessories	
Mounting Sleeve	Anti-corrosion grey PVC+dark grey Aluminium ring
Honeycomb	with honeycomb as optional
Packaging	
Inner box size	150*150*155 mm
Carton size	47.5*32*33.5 cm (12 PCS / carton)

CE RoHS COMPLIANT IP67 IK09

SSS 316 Passivated 1 Year Warranty

Parameter	
General Data	
Item No.	UL-25W-COB-2500-AH
Power	25 Watts
LED type	1PC 25W CREE COB LED
Luminous flux	2100~2300 lm
CCT	2700K, 3000K, 4000K, 6000K
CRI	80+
Beam angle	15°, 23°, 38°, 45°, 60°
Dimension	Ø135x107 (mm) Diameter x length
Cut out	110 mm
Net weight	1.735 kgs
Warranty	1 year
Certifications	CE, RoHS
Electrical Data	
Input voltage	AC95~265V
Insulation class	Class I
Cable	1PC rubber cable 1M H05RN-F 3x1mm square
Driver	Built-in high voltage constant current driver with transformer
Construction Data	
IP rating	IP67 Waterproof
IK rating	IK09
Housing	Solid Passivated (Anodizing) Aluminum CNC machined
Protection finishing	20~25µm thickness anodized film for housing. Dark grey
Trim	Stainless steel 316
Glass	Step tempered Glass. T=10mm.
Loading capacity	2000 kgs
Cable Gland	PG9 IP67
Gasket	O-ring PMQ silicone seal
Accessories	
Mounting Sleeve	Anti-corrosion grey PVC with screws fixed
Honeycomb	with honeycomb as optional
Packaging	
Inner box size	150*150*155 mm
Carton size	47.5*32*33.5 cm (12PCS / carton)



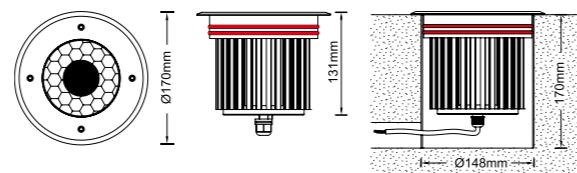
CE RoHS COMPLIANT IP67 IK08
SSS 316 1 Year Warranty

Parameter	
General Data	
Item No.	UL-25W-COB-2500EH
Power	25 Watts ±10%
LED type	1 PC 25V CREE COB LED
Luminous flux	1600lm~1800lm ±10%
CCT	2700K, 3000K, 4000K, 6000K
CRI	80+
Beam angle	10°, 23°, 36°
Dimension	Ø110 x 120 (mm) Diameter x length
Cut out	90 mm
Net weight	1.2 kgs
Warranty	1 year
Certifications	CE, RoHS
Electrical Data	
Input voltage	AC 100~265V
Insulation class	Class I
Cable	1PC rubber cable 1M HO5RN-F 3x1mm square
Driver	High voltage constant current output, with the transformer
Construction Data	
IP rating	IP67 Waterproof
IK rating	IK08
Housing	Solid Passivated (Anodizing) Aluminum CNC machined
Protection finishing	20~25µm thickness anodized film for housing. Dark grey
Trim	Stainless steel 316
Glass	Step tempered Glass. T=8mm.
Loading capacity	500 kgs
Cable Gland	PG gland
Gasket	O-ring PMQ silicone seal
Accessories	
Mounting Sleeve	Passivated (Anodizing) Aluminum CNC machined. Dark grey
Honeycomb	with honeycomb as optional
Packaging	
Inner box size	160*130*130 mm
Carton size	34.5*28.5*28.5 cm [8 PCS / carton]

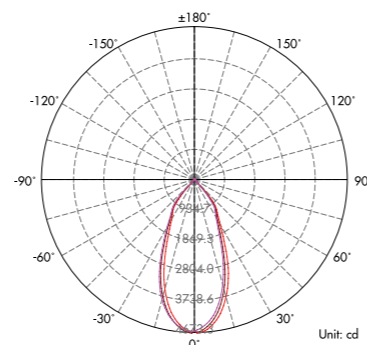




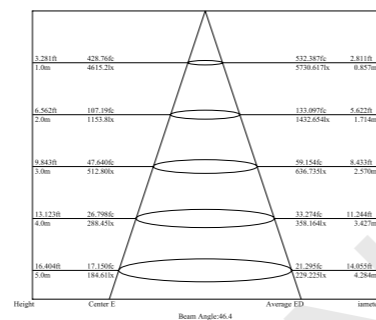
Dimension



Light Distribution Curve (3000K, 1x38°)



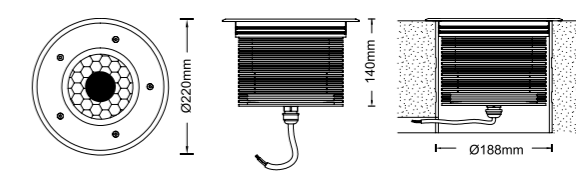
Lux distance Curve (3000K, 1x38°)



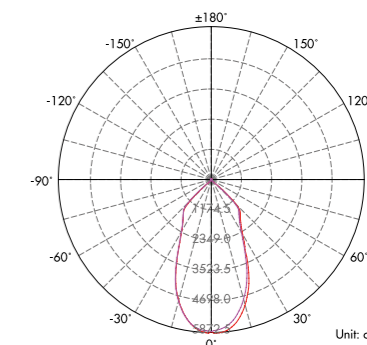
Illumination Picture (1x38°)



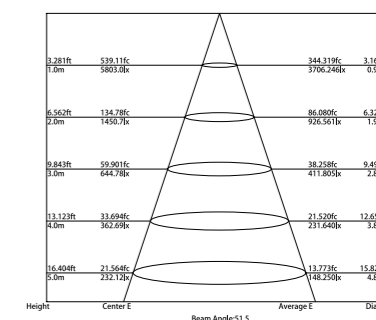
Dimension



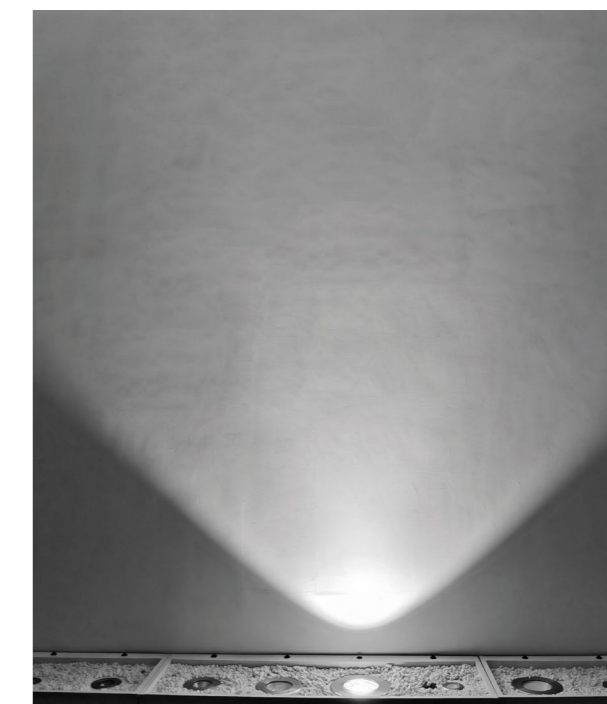
Light Distribution Curve (3000K, 1x24°)



Lux distance Curve (3000K, 1x24°)



Illumination Picture (1x24°)



CE RoHS COMPLIANT IP67 IK09

SSS 316 Passivated 1 Year Warranty

Parameter

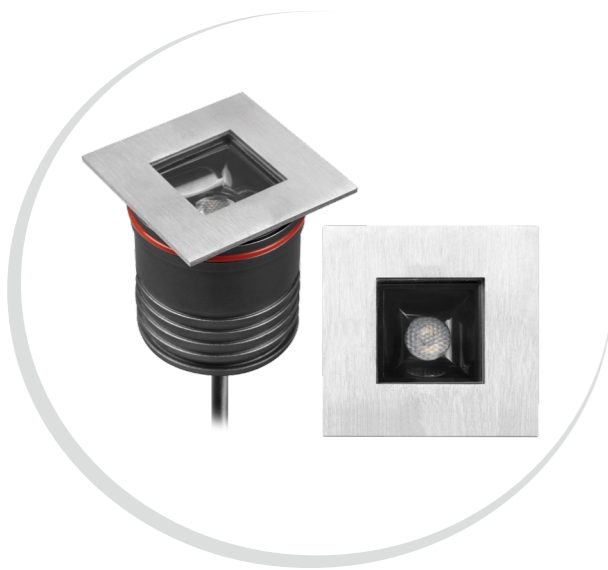
General Data	
Item No.	UL36W-COB-3600AH
Power	36 Watts
LED type	1PC 36W CREE COB LED
Luminous flux	2880~3060 lm
CCT	2700K, 3000K, 4000K, 6000K
CRI	80+
Beam angle	15°, 24°, 38°, 60°
Dimension	Ø170x131 (mm) Diameter x length
Cut out	110 mm
Net weight	3.490 kgs
Warranty	1 year
Certifications	CE, RoHS
Electrical Data	
Input voltage	AC95~265V
Insulation class	Class I
Cable	1PC rubber cable 1M H05RN-F 3x1mm square
Driver	Built-in high voltage constant current driver with transformer
Construction Data	
IP rating	IP67 Waterproof
IK rating	IK09
Housing	Solid Passivated (Anodizing) Aluminum CNC machined
Protection finishing	20~25µm thickness anodized film for housing. Dark grey
Trim	Stainless steel 316
Glass	Step tempered Glass. T=10mm.
Loading capacity	2000 kgs
Cable Gland	PG9 IP67
Gasket	O-ring PMQ silicone seal
Accessories	
Mounting Sleeve	Passivated (Anodizing) Aluminum CNC machined. Dark grey
Honeycomb	with honeycomb as optional
Packaging	
Inner box size	178*178*185 mm
Carton size	37.5*37.5*20.5 cm (4PCS / carton)

CE RoHS COMPLIANT IP67 IK09

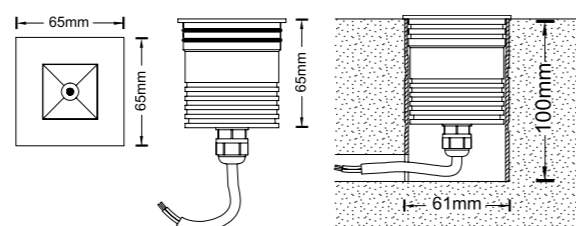
SSS 316 Passivated 1 Year Warranty

Parameter

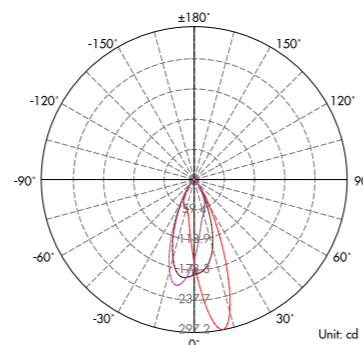
General Data	
Item No.	UL50W-COB-5000AH
Power	50 Watts
LED type	1PC 50W CREE COB LED
Luminous flux	5600~5800 lm
CCT	2700K, 3000K, 4000K, 6000K
CRI	80+
Beam angle	24°, 60°
Dimension	Ø220 x 140 (mm) Diameter x length
Cut out	188 mm
Net weight	4.32 kgs
Warranty	1 year
Certifications	CE, RoHS
Electrical Data	
Input voltage	AC100~265V
Insulation class	Class I
Cable	1PC rubber cable 1M H05RN-F 3x1mm square
Driver	Built-in high voltage constant current driver with transformer
Construction Data	
IP rating	IP67 Waterproof
IK rating	IK09
Housing	Solid Passivated (Anodizing) Aluminum CNC machined
Protection finishing	20~25µm thickness anodized film for housing. Dark grey
Trim	Stainless steel 316
Glass	Step tempered Glass. T=10mm.
Loading capacity	2000 kgs
Cable Gland	PG9 IP67
Gasket	O-ring PMQ silicone seal
Accessories	
Mounting Sleeve	Passivated (Anodizing) Aluminum CNC machined. Dark grey
Honeycomb	with honeycomb as optional
Packaging	
Inner box size	178*178*185 mm
Carton size	37.5*37.5*20.5 cm (4PCS / carton)



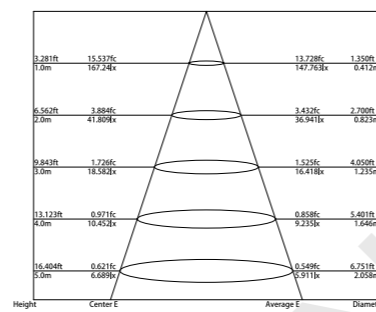
Dimension



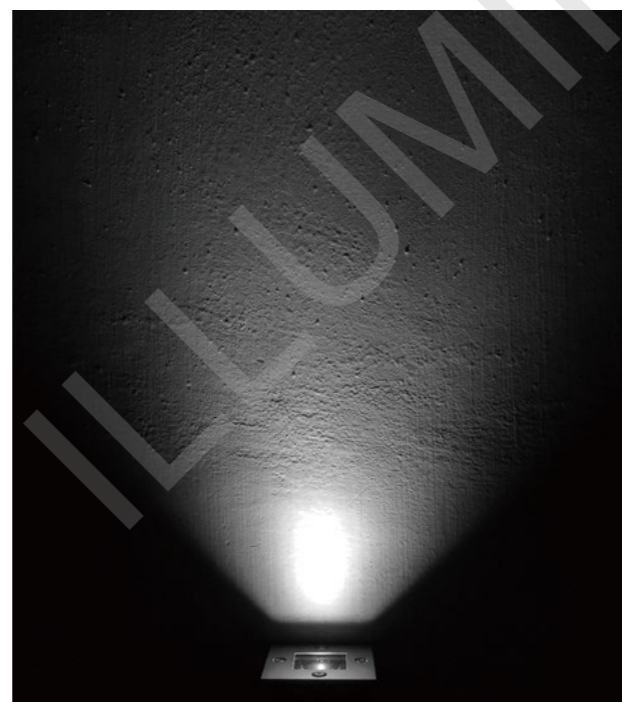
Light Distribution Curve (3000K, 1x24°)



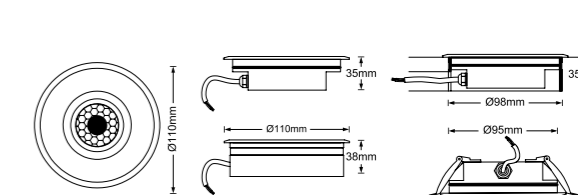
Lux distance Curve (3000K, 1x24°)



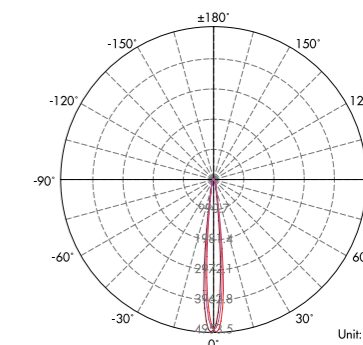
Illumination Picture (1x24°)



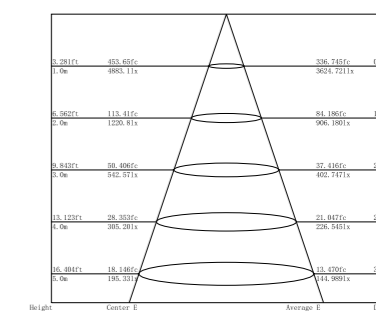
Dimension



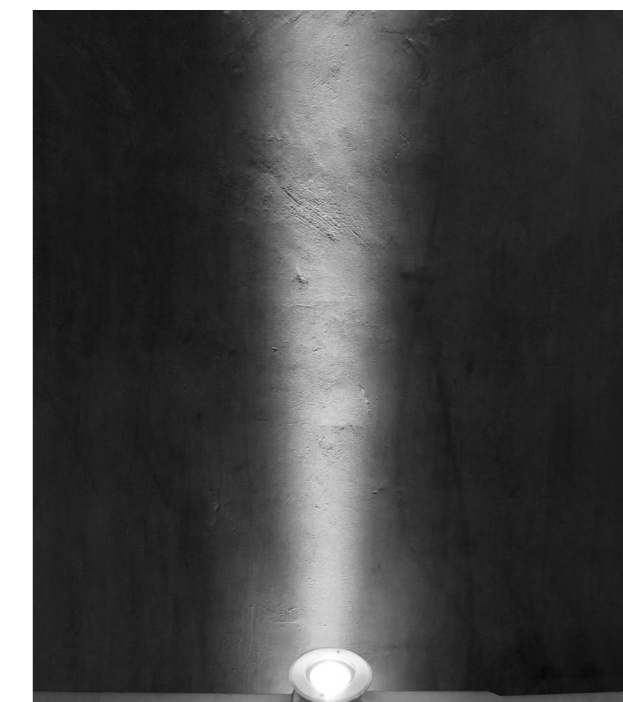
Light Distribution Curve (3000K, 10°)



Lux distance Curve (3000K, 10°)



Illumination Picture (10°)



CE RoHS COMPLIANT IP67 IK06

SSS 316 Passivated 1 Year Warranty

Parameter

General Data	
Item No.	UL-1020-0500-A
Power	5 Watts (10W, 15W coming later)
LED type	1 PC 5W CREE XPG LED
Luminous flux	350~400 lm
CCT	2700K, 3000K, 4000K, 6000K
CRI	80+
Beam angle	12°, 34°, 48° or Lens 10°, 24°, 36°, 48°, 10°*35°
Dimension	65x65x65(mm) Width x Length x Height
Cut out	61 mm
Net weight	0.45 kgs
Warranty	1 year
Certifications	CE, RoHS
Electrical Data	
Input voltage	DC 12V/DC24V (AC 100~265V optional)
Insulation class	Class III
Cable	1PC rubber cable 1.5M H05RN-F 2 or 3x0.75mm square
Driver	Low voltage constant current output, excluding the transformer
Construction Data	
IP rating	IP67 Waterproof
IK rating	IK06
Housing	Solid Passivated (Anodizing) Aluminum CNC machined
Protection finishing	20~25µm thickness anodized film for housing. Dark grey
Trim	Stainless steel 316
Glass	Step tempered Glass. T=8mm.
Loading capacity	320 kgs
Cable Gland	PG9 IP67
Gasket	O-ring PMQ silicone seal
Accessories	
Mounting Sleeve	Passivated (Anodizing) Aluminum CNC machined. Dark grey
Packaging	
Inner box size	110*105*70 mm
Carton size	44.5*35.5*16.5 cm (24PCS / carton)

CE RoHS COMPLIANT IP67 IK08

SSS 316 1 Year Warranty

Used as inground lights, downlights, deck lights !

Parameter

General Data	
Item No.	UL-6W-COB-06001
Power	6 Watts +10%
LED type	1 PC 6W CREE COB LED
Luminous flux	415lm ~435lm +10%
CCT	2700K, 3000K, 4000K, 6000K
CRI	80+
Beam angle	10°, 20°, 30°
Dimension	Ø110x35 (mm) Diameter x length
Cut out	98 mm with sleeve, 95mm with clip
Net weight	0.55 kgs
Warranty	1 year
Certifications	CE, RoHS
Electrical Data	
Input voltage	DC24V
Insulation class	Class III
Cable	1PC rubber cable 1M H05RN-F 2x1mm square
Driver	Low voltage constant current output, excluding the transformer
Construction Data	
IP rating	IP67 Waterproof
IK rating	IK08
Housing	Solid Passivated (Anodizing) Aluminum CNC machined
Protection finishing	20~25µm thickness anodized film for housing. Dark grey
Trim	Stainless steel 316
Glass	Step tempered Glass. T=8mm.
Loading capacity	500 kgs
Cable Gland	PG gland
Gasket	O-ring PMQ silicone seal
Accessories	
Mounting Sleeve	Passivated (Anodizing) Aluminum CNC machined. Dark grey
Clip	With spring as options, that's for wall lights, deck lights or ceiling lights application
Packaging	
Inner box size	120*120*60 mm
Carton size	38.5*26.5*20.5 cm (18 PCS / carton)



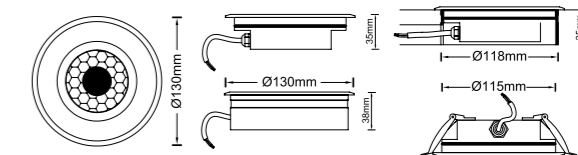
CE RoHS COMPLIANT IP67 IK08

Ultra slim Passivated 1 Year Warranty

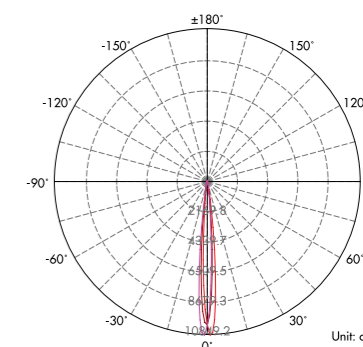
Parameter

General Data	
Item No.	UL-9W-COB-09004
Power	9 Watts
LED type	1 PC 9W CREE COB LED
Luminous flux	Clear glass: 435-490lm; Middle black painting glass: 345-445lm
CCT	2700K, 3000K, 4000K, 6000K
CRI	80+
Beam angle	10°, 20°, 30°
Dimension	Ø130x35 (mm) Diameter x Height
Cut out	Inground light: Ø118 mm Deck light: Ø115 mm
Net weight	0.72 KGS
Warranty	1 year
Certifications	CE, RoHS
Electrical Data	
Input voltage	DC 24V
Insulation class	Class III
Cable	1PC rubber cable 1M H05RN-F 2x1mm square
Driver	Built-in low voltage constant current driver without transformer
Control	ON/OFF / PWM
Construction Data	
IP rating	IP67 Waterproof
IK rating	IK08
Housing	Solid Passivated (Anodizing) Aluminum CNC machined
Protection finishing	20~25µm thickness anodized film for housing. Dark grey color
Trim	Stainless steel 316
Glass	Step tempered clear glass as standard T=8mm. (middle black painting glass optional)
Loading capacity	2000 kgs
Cable Gland	PG7 IP67
Gasket	O-ring PMQ silicone seal
Accessories	
Mounting sleeve	Aluminium sleeve used as inground light
Clip	Two clips with screws optional used as downlight / deck light
Packaging	
Inner box size	140 * 140 * 60 mm
Carton size	30.5 * 30.5 * 20.5CM (112PCS/CTN)

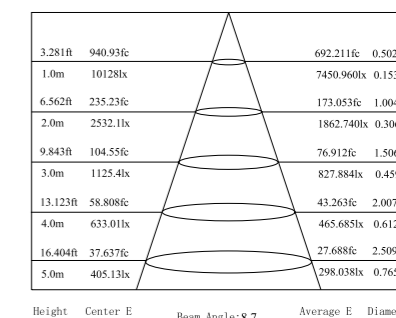
Dimension



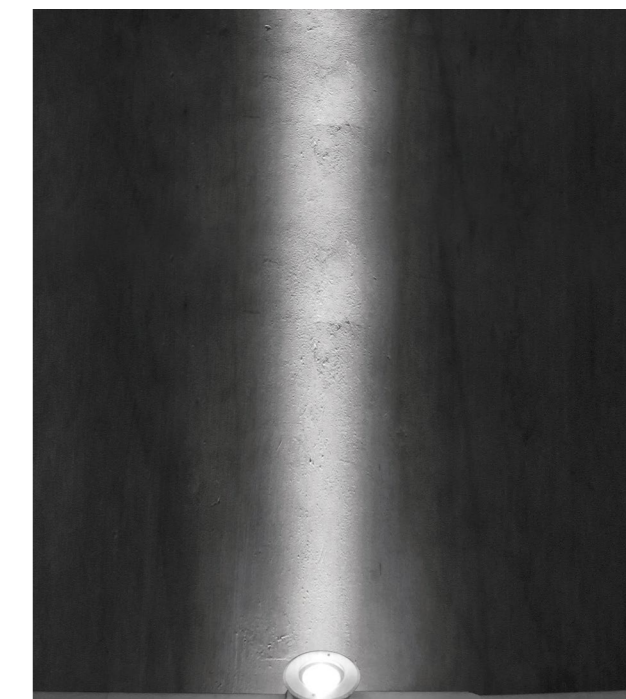
Light Distribution Curve (3000K, 10°)



Lux distance Curve (3000K, 10°)

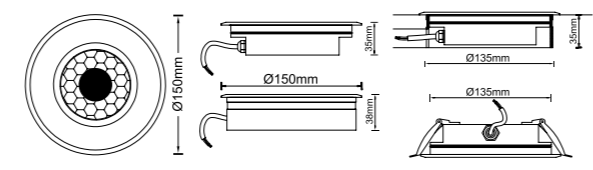


Illumination Picture (10°)

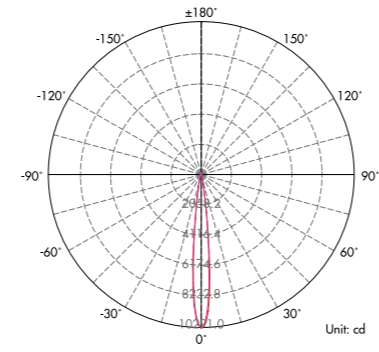




Dimension



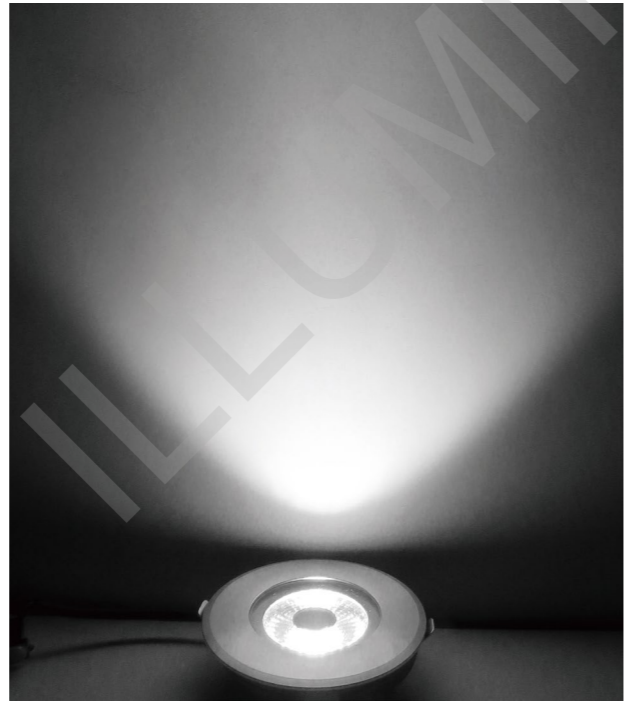
Light Distribution Curve (3000K,30°)



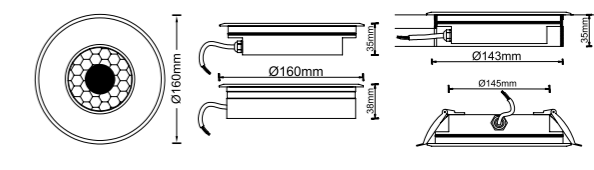
Lux distance Curve (3000K,30°)

Height	Center E	Beam Angle:11.5	Average E	Diameter
3.281ft	956.066ft		700.367ft	0.662ft
1.0m	10291lx		7538.750lx	0.202m
6.562ft	239.016lx		175.092lx	1.323ft
2.0m	2572.8lx		1884.687lx	0.403m
9.843ft	106.23lx		77.819lx	1.985ft
3.0m	1143.4lx		837.639lx	0.605m
13.123ft	59.754lx		43.773lx	2.646ft
4.0m	643.19lx		471.172lx	0.807m
16.404ft	38.242lx		28.015lx	3.308ft
5.0m	411.64lx		301.550lx	1.008m

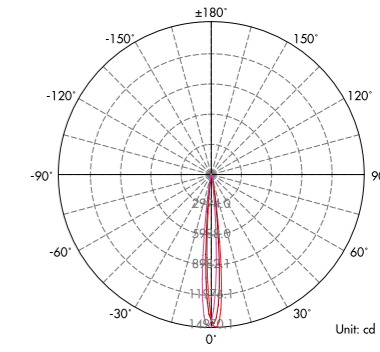
Illumination Picture (30°)



Dimension



Light Distribution Curve (3000K,20°)



Lux distance Curve (3000K,20°)

Height	Center E	Beam Angle:10.0	Average E	Diameter
3.281ft	1332.5lx		962.453lx	0.572ft
1.0m	14343lx		10359.844lx	0.174m
6.562ft	333.13lx		240.613lx	1.143ft
2.0m	3585.8lx		2589.961lx	0.348m
9.843ft	148.06lx		106.939lx	1.715ft
3.0m	1593.7lx		1151.094lx	0.523m
13.123ft	83.282lx		60.155lx	2.287ft
4.0m	896.45lx		647.490lx	0.697m
16.404ft	53.301lx		38.498lx	2.858ft
5.0m	573.73lx		414.394lx	0.871m

Illumination Picture (20°)



CE RoHS COMPLIANT IP67 IK08

Ultra slim Passivated 1 Year Warranty

Parameter

General Data	
Item No.	UL-12W-COB-1200H
Power	12 Watts
LED type	1 PC 12W CREE COB LED
Luminous flux	Clear glass: 830~950lm; Middle black painting glass:470~600lm
CCT	2700K, 3000K, 4000K, 6000K
CRI	80+
Beam angle	10°, 20°, 30°
Dimension	Ø150x35(mm) Diameter x Height
Cut out	Inground light: Ø135mm Deck light: Ø135mm
Net weight	0.98 KGS
Warranty	1 year
Certifications	CE, RoHS
Electrical Data	
Input voltage	DC 24V
Insulation class	Class III
Cable	1PC rubber cable 1M H05RN-F 2x1mm square
Driver	Built-in low voltage constant current driver without transformer
Control	ON\OFF / PWM
Construction Data	
IP rating	IP67 Waterproof
IK rating	IK08
Housing	Solid Passivated (Anodizing) Aluminum CNC machined
Protection finishing	20~25µm thickness anodized film for housing. Dark grey color
Trim	Stainless steel 316
Glass	Step tempered clear glass as standard T=8mm. (middle black painting glass optional)
Loading capacity	2000 kgs
Cable Gland	PG7 IP67
Gasket	O-ring PMQ silicone seal
Accessories	
Mounting sleeve	Aluminium sleeve used as inground light
Clip	Two clips with screws optional used as downlight / deck light
Packaging	
Inner box size	160*160*60 mm
Carton size	34.5*34.5*20.5CM (12PCS/CTN)

CE RoHS COMPLIANT IP67 IK08

Ultra slim Passivated 1 Year Warranty

Parameter

General Data	
Item No.	UL-15W-COB-1500H
Power	15 Watts
LED type	1 PC 15W CREE COB LED
Luminous flux	Clear glass: 1000~1060lm; Middle black painting glass: 650~900lm
CCT	2700K, 3000K, 4000K, 6000K
CRI	80+
Beam angle	10°, 20°, 30°
Dimension	Ø160x35 (mm) Diameter x Height
Cut out	Inground light: Ø143mm Deck light: Ø145mm
Net weight	1.1 KGS
Warranty	1 year
Certifications	CE, RoHS
Electrical Data	
Input voltage	DC 24V
Insulation class	Class III
Cable	1PC rubber cable 1M H05RN-F 2x1mm square
Driver	Built-in low voltage constant current driver without transformer
Control	ON\OFF / PWM
Construction Data	
IP rating	IP67 Waterproof
IK rating	IK08
Housing	Solid Passivated (Anodizing) Aluminum CNC machined
Protection finishing	20~25µm thickness anodized film for housing. Dark grey color
Trim	Stainless steel 316
Glass	Step tempered clear glass as standard T=8mm. (middle black painting glass optional)
Loading capacity	2000 kgs
Cable Gland	PG7 IP67
Gasket	O-ring PMQ silicone seal
Accessories	
Mounting sleeve	Aluminium sleeve used as inground light
Clip	Two clips with screws optional used as downlight / deck light
Packaging	
Inner box size	170*170*60 mm
Carton size	36.5*36.5*14CM (8PCS/CTN)

INGROUND LIGHTS SERIES

INGROUND LIGHTS SERIES



INGROUND LIGHTS SERIES

1.6 ASYMMETRIC SMD LED GROUND SPOT SERIES



Illustration of downward asymmetrical light

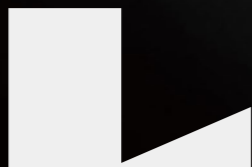
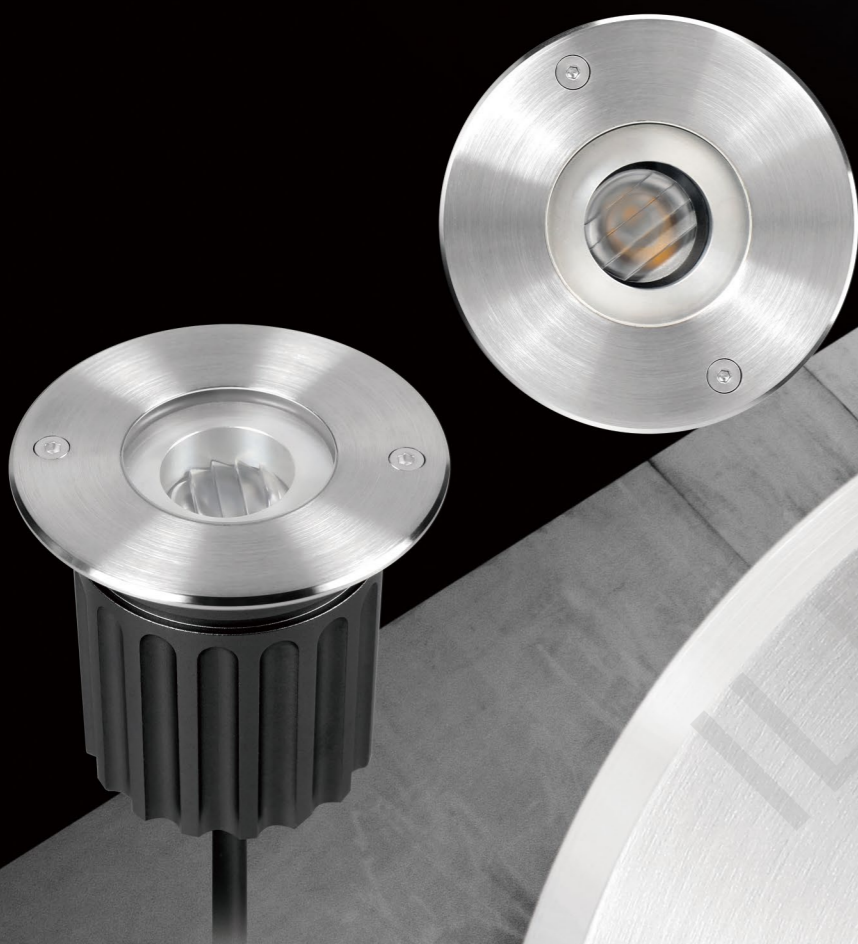
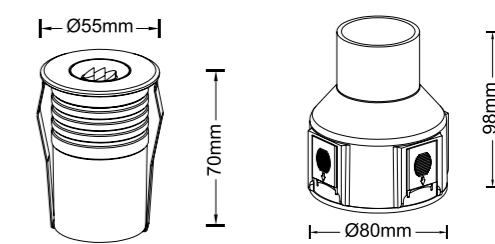


Illustration of upward asymmetrical light

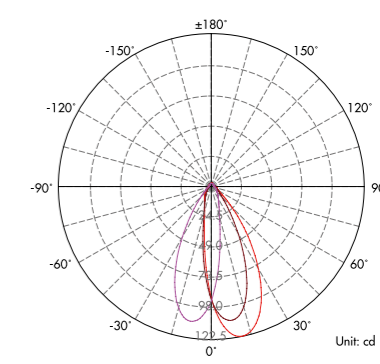




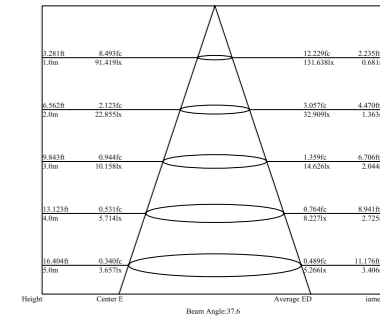
Dimension



Light Distribution Curve (3000K, 15x30°)



Lux distance Curve (3000K, 15x30°)



Illumination Picture (15x30°)



CE RoHS COMPLIANT IP67 IK06

SSS 316 Passivated 1 Year Warranty

Asymmetric lens

Parameter	
General Data	
Item No.	UL-1009-0300C
Power	3 Watts
LED type	1 PC 3W CREE XPE LED
Luminous flux	110~130 lm
CCT	2700K, 3000K, 4000K, 6000K, R/G/Y/B
CRI	80+
Beam angle	Symmetric: 5°, 10°, 17°, 23°, 28°, 43°, 58° Asymmetric: 15°x25°, 15°x30°, 15°x45°, 15°x60° (tilt + pan)
Dimension	55x70 (mm) Diameter x Height
Cut out	80 mm
Net weight	0.356 kgs
Warranty	1 year
Certifications	CE, RoHS
Electrical Data	
Input voltage	DC24V / DC12V as standard, (AC100~240V as options)
Insulation class	Class III
Cable	1PC rubber cable 1M H05RN-F 2x1mm square
Driver	Low voltage constant current output, excluding the transformer
Construction Data	
IP rating	IP67 Waterproof
IK rating	IK06
Housing	Solid Passivated (Anodizing) Aluminum CNC machined
Protection finishing	20~25µm thickness anodized film for housing, Dark grey
Trim	Stainless steel 316
Glass	Step tempered Glass, T=6mm.
Loading capacity	320 kgs
Cable Gland	PG7 IP67
Gasket	O-ring PMQ silicone seal
Accessories	
Mounting Sleeve	Anti-corrosion black PVC, with screws fixed
Packaging	
Inner box size	88*88*105 mm
Carton size	46*28.5*24 cm (30PCS / carton)

INGROUND LIGHTS SERIES





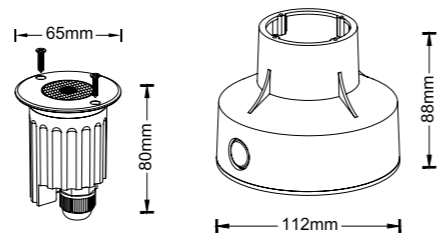
CE RoHS COMPLIANT IP67 IK06

SSS 316 Passivated 1 Year Warranty

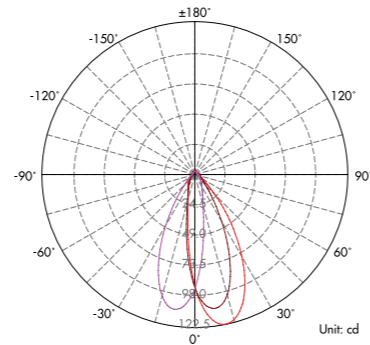
Parameter

General Data	
Item No.	UL-1008-0500B
Power	5 Watts
LED type	1 PCSWV Cree XPG LED
Luminous flux	350~400 lm
CCT	2700K, 3000K, 4000K, 6000K
CRI	80+
Beam angle	Symmetric: 5°, 10°, 17°, 23°, 28°, 43°, 58° Asymmetric: 15°x25°, 15°x30°, 15°x45°, 15°x60° (tilt +pan)
Dimension	Ø65x80 (mm) Diameter x length
Cut out	112 mm
Net weight	0.48 kgs
Warranty	1 year
Certifications	CE, RoHS
Electrical Data	
Input voltage	DC24V
Insulation class	Class III
Cable	1PC rubber cable 1M H05RN-F 2x1mm square
Driver	Low voltage constant current output, excluding the transformer
Construction Data	
IP rating	IP67 Waterproof
IK rating	IK06
Housing	Solid Passivated (Anodizing) Aluminum CNC machined
Protection finishing	20~25µm thickness anodized film for housing. Dark grey
Trim	Stainless steel 316
Glass	Step tempered Glass. T=8mm.
Loading capacity	320 kgs
Cable Gland	PG7 IP67
Gasket	O-ring PMQ silicone seal
Accessories	
Mounting sleeve	Anti-corrosion black PVC
Packaging	
Inner box size	117*117*105 mm
Carton size	48.5*25*34 cm [24PCS / carton]

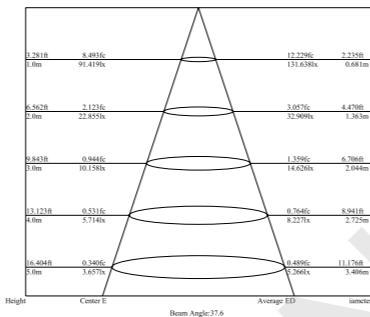
Dimension



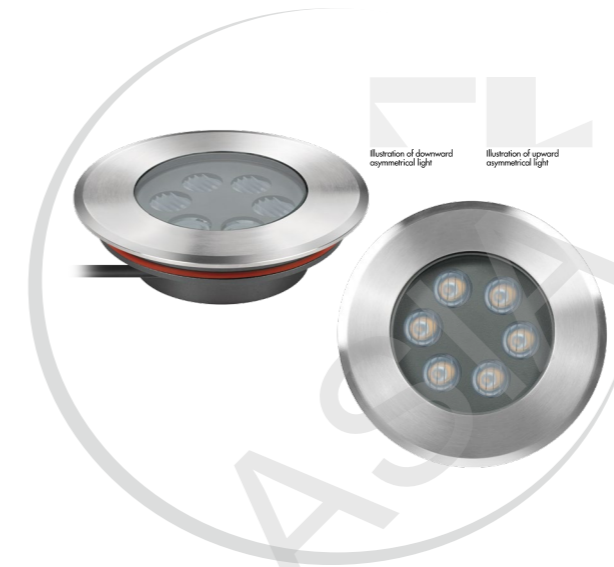
Light Distribution Curve (3000K, 10°)



Lux distance Curve (3000K, 10°)



Illumination Picture (10°)



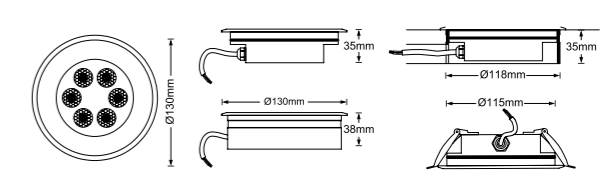
CE RoHS COMPLIANT IP67 IK08

Ultra slim Passivated 1 Year Warranty

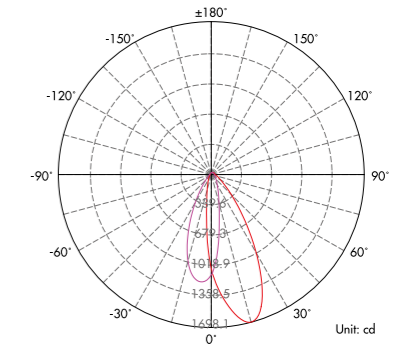
Parameter

General Data	
Item No.	UL-6001-0900H
Power	9 Watts
LED type	6 PCS OSRAM SMD LED
Luminous flux	480-540lm
CCT	2700K, 3000K, 4000K, 6000K
CRI	80+
Beam angle	Symmetric: 5°, 10°, 17°, 23°, 28°, 43°, 58° Asymmetric: 15°x25°, 15°x30°, 15°x45°, 15°x60° (tilt +pan)
Dimension	Ø130x35 (mm) Diameter x Height
Cut out	Inground light: Ø118 mm Deck light: Ø115 mm
Net weight	0.72 KGS
Warranty	1 year
Certifications	CE, RoHS
Electrical Data	
Input voltage	DC 24V
Insulation class	Class III
Cable	1PC rubber cable 1M H05RN-F 2x1mm square
Driver	Built-in low voltage constant current driver without transformer
Control	ON\OFF / PWM
Construction Data	
IP rating	IP67 Waterproof
IK rating	IK08
Housing	Solid Passivated (Anodizing) Aluminum CNC machined
Protection finishing	20~25µm thickness anodized film for housing. Dark grey color
Trim	Stainless steel 316
Glass	Step tempered Glass. T=8mm.
Loading capacity	2000 kgs
Cable Gland	PG7 IP67
Gasket	O-ring PMQ silicone seal
Accessories	
Mounting sleeve	Aluminium sleeve used as inground light
Clip	Two clips with screws optional used as downlight / deck light
Packaging	
Inner box size	140*140*60 mm
Carton size	30.5*30.5*20.5CM (12PCS/CTN)

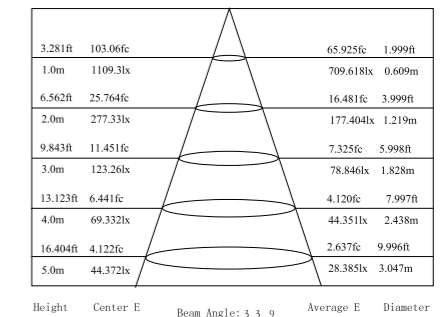
Dimension



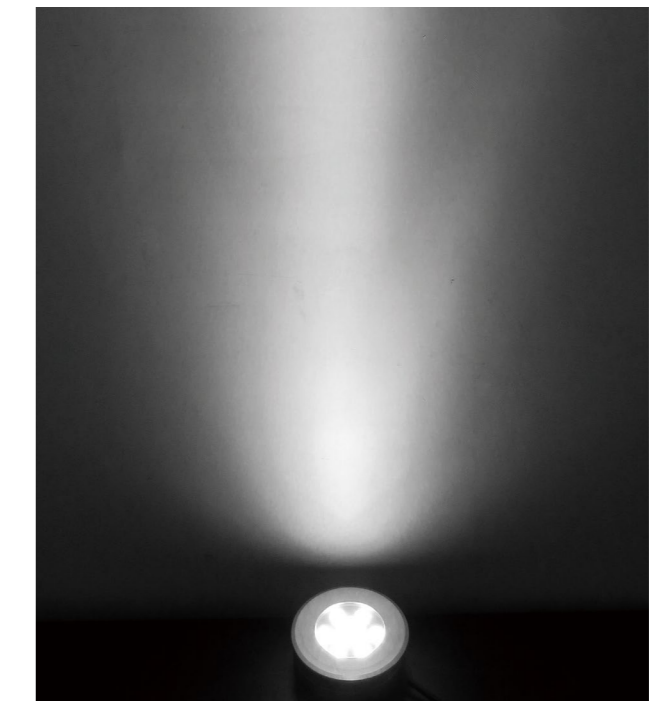
Light Distribution Curve (3000K, 10°+30°)

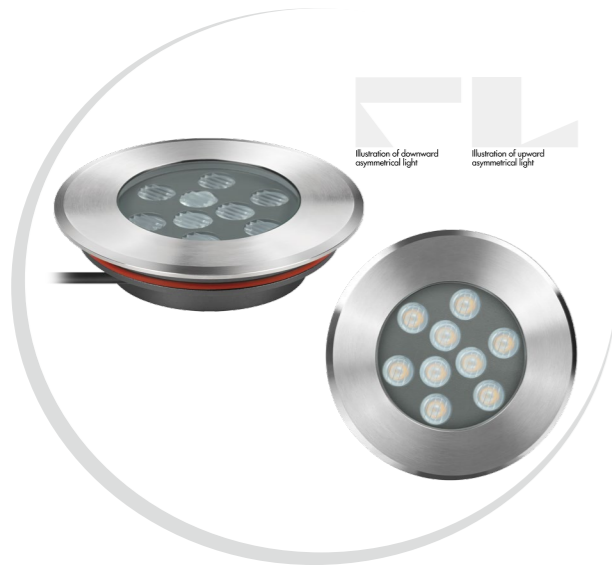


Lux distance Curve (3000K, 10°+30°)

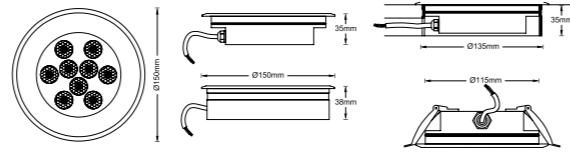


Illumination Picture (10°+30°)

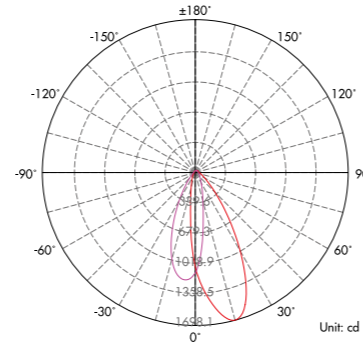




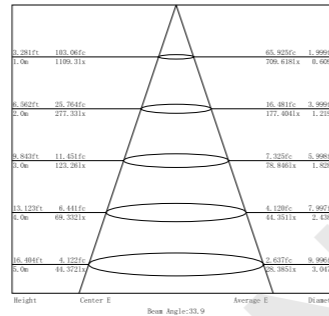
Dimension



Light Distribution Curve (3000K, 15°+30°)



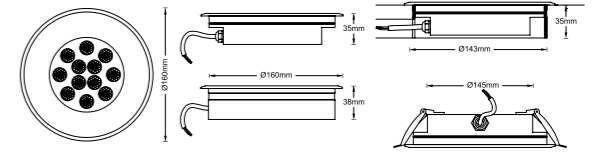
Lux distance Curve (3000K, 15°+30°)



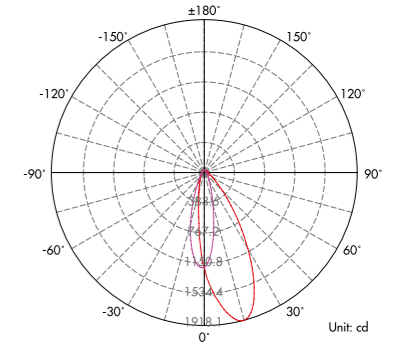
Illumination Picture (15°+30°)



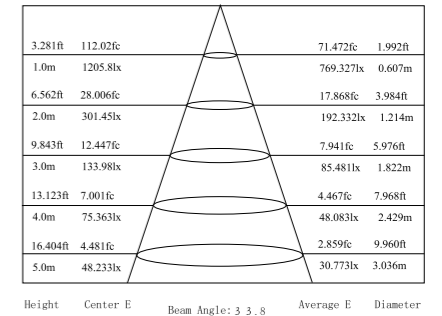
Dimension



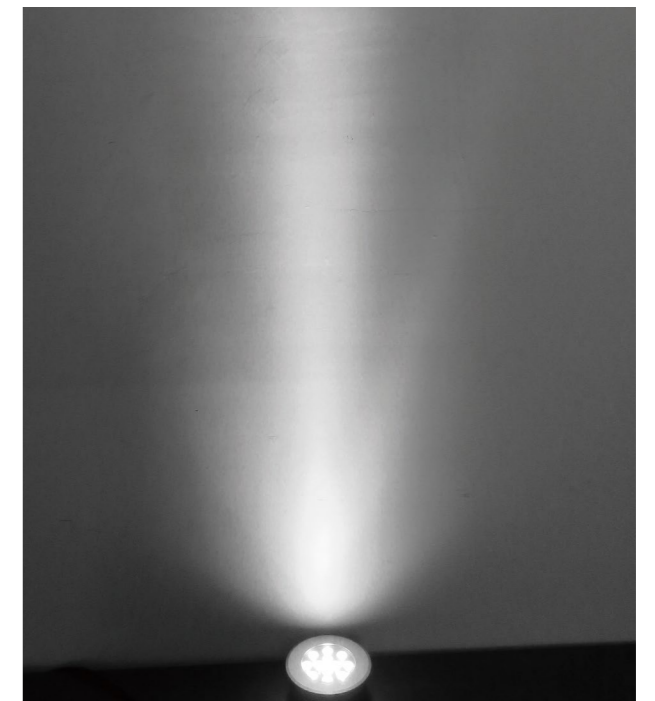
Light Distribution Curve (3000K, 15°x15°)



Lux distance Curve (3000K, 15°x15°)



Illumination Picture (15°x15°)



CE RoHS COMPLIANT IP67 IK08

Ultra slim Passivated 1 Year Warranty

Parameter

General Data	
Item No.	UL-9001-1200H
Power	12 Watts
LED type	9 PCS OSRAM SMD LED
Luminous flux	720-810lm
CCT	2700K, 3000K, 4000K, 6000K
CRI	80+
Beam angle	Symmetric: 5°, 10°, 17°, 23°, 28°, 43°, 58° Asymmetric: 15°x25°, 15°x30°, 15°x45°, 15°x60° (tilt +pan)
Dimension	Ø150x35 (mm) Diameter x Height
Cut out	Inground light: Ø135mm Deck light: Ø135mm
Net weight	0.98 KGS
Warranty	1 year
Certifications	CE, RoHS
Electrical Data	
Input voltage	DC 24V
Insulation class	Class III
Cable	1PC rubber cable 1M H05RN-F 2x1mm square
Driver	Built-in low voltage constant current driver without transformer
Control	ON\OFF / PWM
Construction Data	
IP rating	IP67 Waterproof
IK rating	IK08
Housing	Solid Passivated (Anodizing) Aluminum CNC machined
Protection finishing	20~25µm thickness anodized film for housing. Dark grey color
Trim	Stainless steel 316
Glass	Step tempered Glass. T=8mm.
Loading capacity	2000 kgs
Cable Gland	PG7 IP67
Gasket	O-ring PMQ silicone seal
Accessories	
Mounting sleeve	Aluminium sleeve used as inground light
Clip	Two clips with screws optional used as downlight / deck light
Packaging	
Inner box size	160*160*60 mm
Carton size	34.5*34.5*20.5CM (12PCS/CTN)

CE RoHS COMPLIANT IP67 IK08

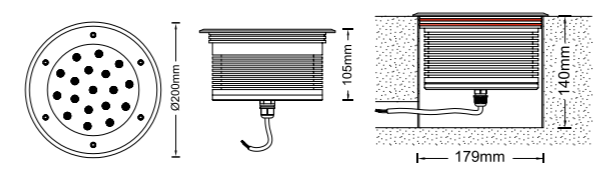
Ultra slim Passivated 1 Year Warranty

Parameter

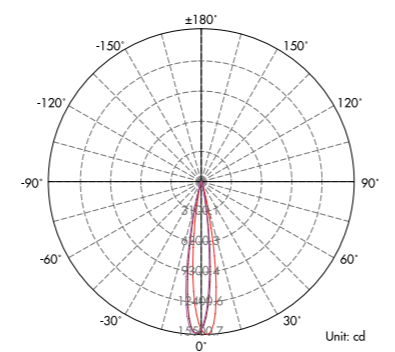
General Data	
Item No.	UL-1201-1500H
Power	15 Watts
LED type	12 PCS OSRAM SMD LED
Luminous flux	960-1080lm
CCT	2700K, 3000K, 4000K, 6000K
CRI	80+
Beam angle	Symmetric: 5°, 10°, 17°, 23°, 28°, 43°, 58° Asymmetric: 15°x25°, 15°x30°, 15°x45°, 15°x60° (tilt +pan)
Dimension	Ø160x35 (mm) Diameter x Height
Cut out	Inground light: Ø143mm Deck light: Ø145mm
Net weight	1.1 KGS
Warranty	1 year
Certifications	CE, RoHS
Electrical Data	
Input voltage	DC 24V
Insulation class	Class III
Cable	1PC rubber cable 1M H05RN-F 2x1mm square
Driver	Built-in low voltage constant current driver without transformer
Control	ON\OFF / PWM
Construction Data	
IP rating	IP67 Waterproof
IK rating	IK08
Housing	Solid Passivated (Anodizing) Aluminum CNC machined
Protection finishing	20~25µm thickness anodized film for housing. Dark grey color
Trim	Stainless steel 316
Glass	Step tempered Glass. T=8mm.
Loading capacity	2000 kgs
Cable Gland	PG7 IP67
Gasket	O-ring PMQ silicone seal
Accessories	
Mounting sleeve	Aluminium sleeve used as inground light
Clip	Two clips with screws optional used as downlight / deck light
Packaging	
Inner box size	170*170*60 mm
Carton size	36.5*36.5*14cm (8PCS/CTN)



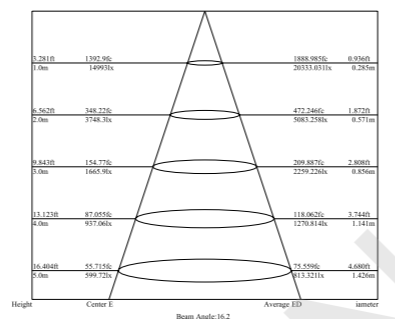
Dimension



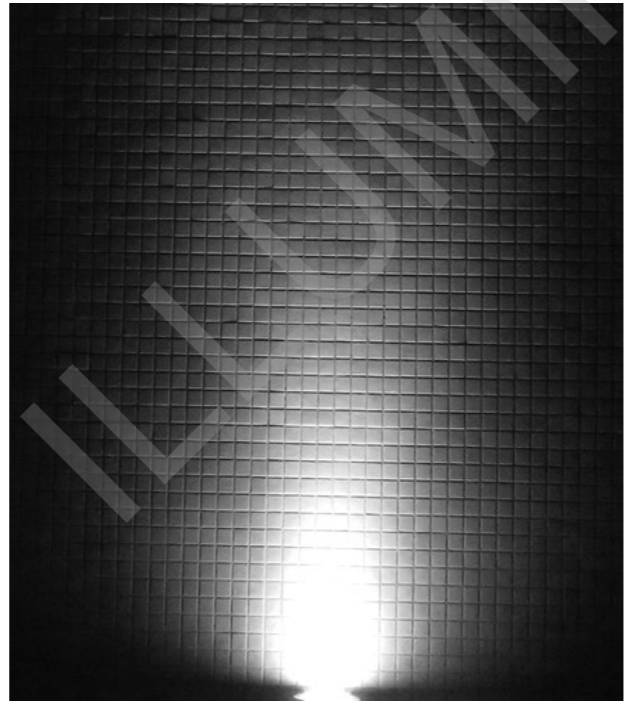
Light Distribution Curve (3000K, 15x15°)



Lux distance Curve (3000K, 15x15°)



Illumination Picture (15x15°)



CE RoHS COMPLIANT IP67 IK09

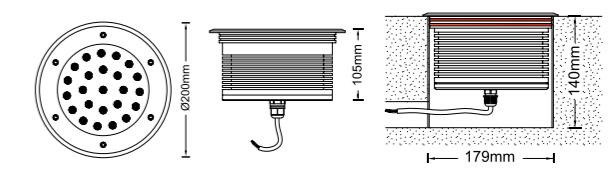
SSS 316 Passivated 1 Year Warranty

Asymmetric lens!

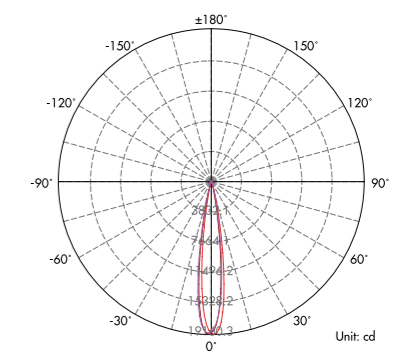
Parameter	
General Data	
Item No.	UL-1801-3000-AH
Power	30 Watts
LED type	18 PCS CREE XPE LED
Luminous flux	1750~1850 lm
CCT	2700K, 3000K, 4000K, 6000K, R/G/Y/B
CRI	80+
Beam angle	Symmetric: 5°, 10°, 17°, 23°, 28°, 43°, 58° Asymmetric: 15°x25°, 15°x30°, 15°x45°, 15°x60° (tilt +pan)
Dimension	200 x 105 (mm) Diameter x Height
Cut out	179 mm
Net weight	4.410 kgs
Warranty	1 year
Certifications	CE, RoHS
Electrical Data	
Input voltage	AC95~265V
Insulation class	Class I
Cable	1PC rubber cable 1M H05RN-F 3x1mm square
Driver	Built-in high voltage constant current driver with transformer
Construction Data	
IP rating	IP67 Waterproof
IK rating	IK09
Housing	Solid Passivated (Anodizing) Aluminum CNC machined
Protection finishing	20~25µm thickness anodized film for housing, Dark grey
Trim	Stainless steel 316
Glass	Step tempered Glass. T=10mm.
Loading capacity	2000 kgs
Cable Gland	PG7 P67
Gasket	O-ring PMQ silicone seal
Accessories	
Mounting sleeve	Passivated (Anodizing) Aluminum CNC machined
Packaging	
Inner box size	210*210*180 mm
Carton size	44*22.5*20 cm (2 PCS / carton)



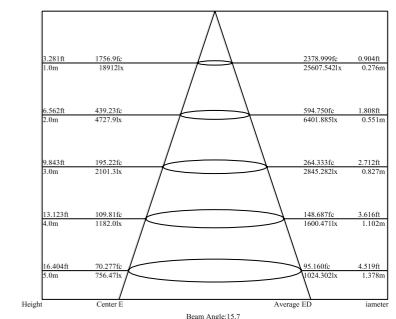
Dimension



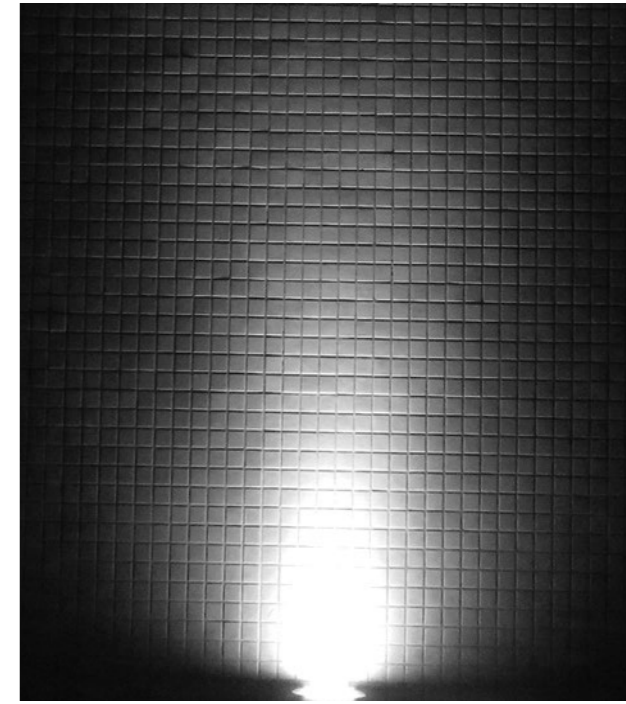
Light Distribution Curve (3000K, 15x15°)



Lux distance Curve (3000K, 15x15°)



Illumination Picture (15x15°)



CE RoHS COMPLIANT IP67 IK09

SSS 316 Passivated 1 Year Warranty

Asymmetric lens!

Parameter	
General Data	
Item No.	UL-2401-4000-BH
Power	40 Watts as standard, (30 watts as options)
LED type	24 PCS CREE XPE LED
Luminous flux	2320~2500 lm
CCT	2700K, 3000K, 4000K, 6000K, R/G/Y/B
CRI	80+
Beam angle	Symmetric: 5°, 10°, 17°, 23°, 28°, 43°, 58° Asymmetric: 15°x25°, 15°x30°, 15°x45°, 15°x60° (tilt +pan)
Dimension	200 x 105 (mm) Diameter x Height
Cut out	179 mm
Net weight	4.435 kgs
Warranty	1 year
Certifications	CE, RoHS
Electrical Data	
Input voltage	AC95~265V
Insulation class	Class I
Cable	1PC rubber cable 1M H05RN-F 3x1mm square
Driver	Built-in high voltage constant current driver with transformer
Construction Data	
IP rating	IP67 Waterproof
IK rating	IK09
Housing	Solid Passivated (Anodizing) Aluminum CNC machined
Protection finishing	20~25µm thickness anodized film for housing, Dark grey
Trim	Stainless steel 316
Glass	Step tempered Glass. T=10mm.
Loading capacity	2000 kgs
Cable Gland	PG7 IP67
Gasket	O-ring PMQ silicone seal
Accessories	
Mounting sleeve	Passivated (Anodizing) Aluminum CNC machined
Packaging	
Inner box size	210*210*180 mm
Carton size	44*22.5*20 cm (2 PCS / carton)

INGROUND LIGHTS SERIES

1.7 ASYMMETRIC COB LED GROUND SPOT SERIES

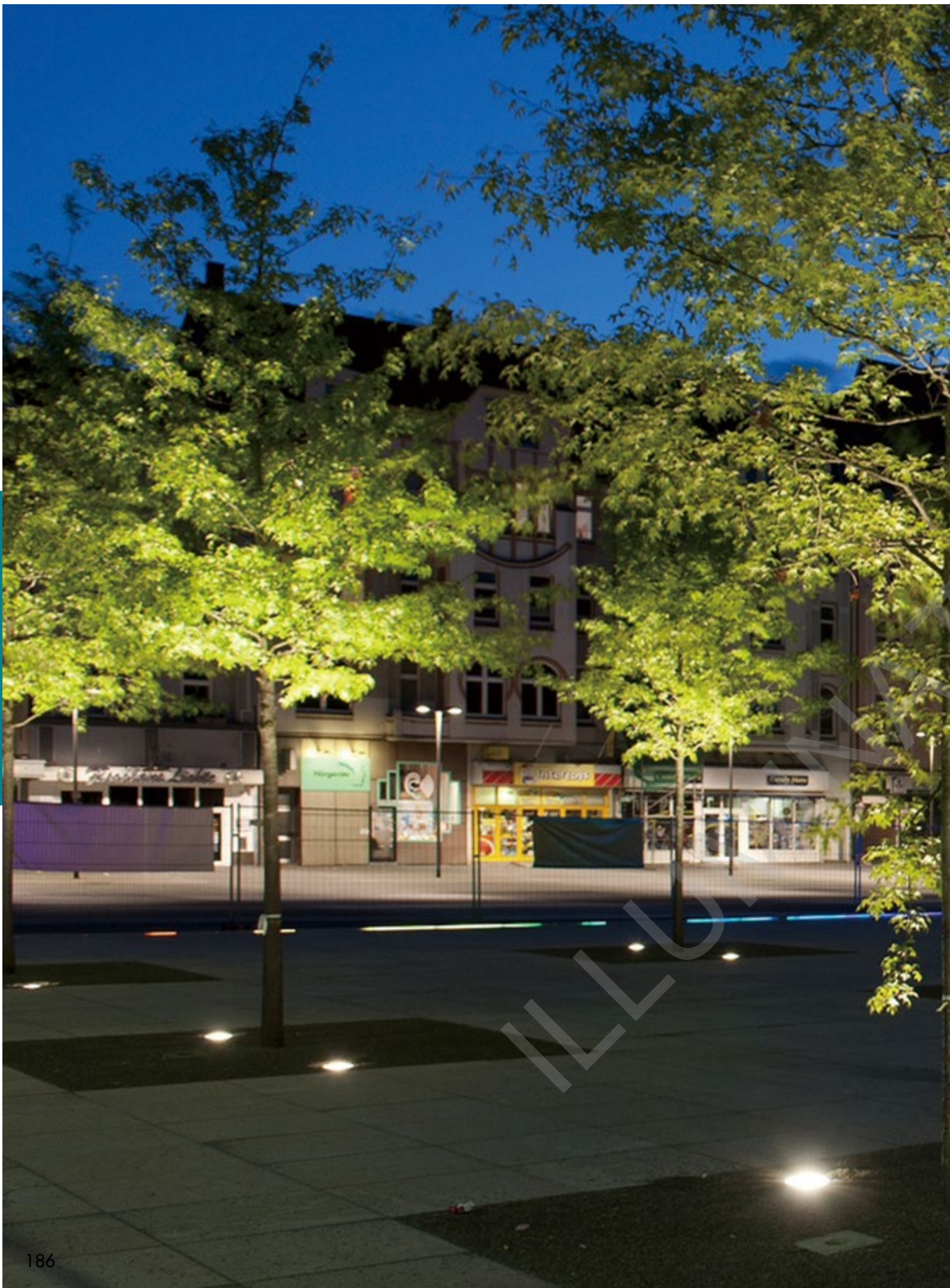


Illustration of downward asymmetrical light



Illustration of upward asymmetrical light



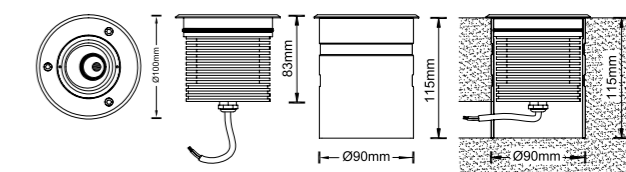


CE RoHS COMPLIANT IP67 IK08

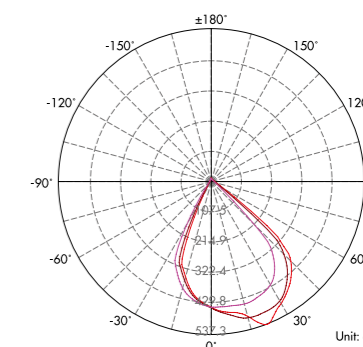
Passivated 1 Year Warranty

Parameter	
General Data	
Item No.	UL-15W-COB-1500-DH
Power	1.5 Watts
LED type	1 PC 1.5W CREE COB LED
Luminous flux	Black reflector: 540~640 lm; White reflector: 810~960lm
CCT	2700K, 3000K, 4000K, 6000K
CRI	80+
Beam angle	Asymmetric 15°x 70° (Tilt x Pan)
Dimension	Ø100x83 (mm) Diameter x Height
Cut out	Ø90 mm
Net weight	0.95 KGS
Warranty	1 year
Certifications	CE, RoHS
Electrical Data	
Input voltage	AC 100~245V
Insulation class	Class I
Cable	1PC rubber cable 1M H05RN-F 3x1mm square
Driver	Built-in high voltage constant current driver with transformer
Construction Data	
IP rating	IP67 Waterproof
IK rating	IK08
Housing	Solid Passivated (Anodizing) Aluminum CNC machined
Protection finishing	20~25µm thickness anodized film for housing. Dark grey color
Trim	Stainless steel 316
Glass	Step tempered Glass. T=8mm.
Loading capacity	2000 kgs
Cable Gland	PG7 IP67
Gasket	O-ring PMQ silicone seal
Accessories	
Mounting sleeve	Anticorrosion black PVC with screws fixed
Packaging	
Inner box size	110*110*125 mm
Carton size	35*35*27.5 cm (18PCS/CTN)

Dimension



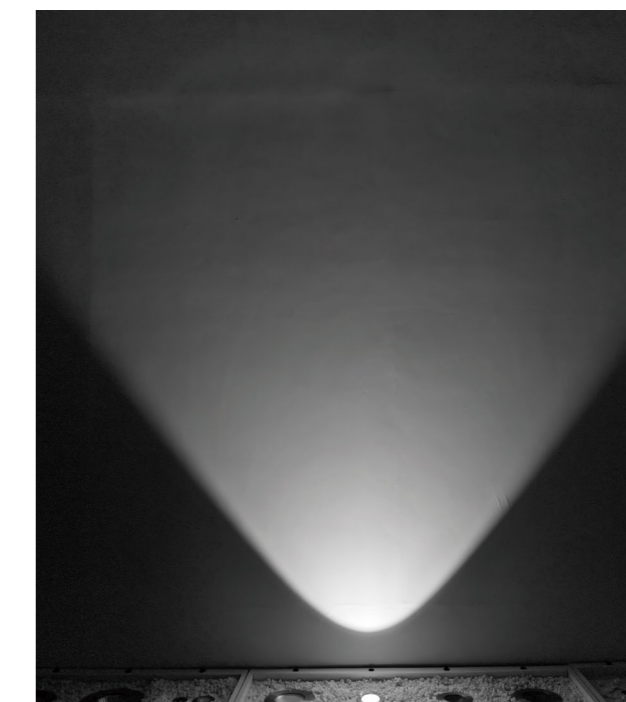
Light Distribution Curve (3000K, 15°x 70°)



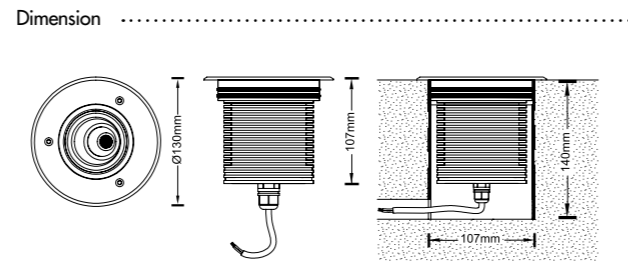
Lux distance Curve (3000K, 15°x 70°)

Height	Center E	Beam Angle: 70.4	Average E	Diameter
3.281ft	41.116fc		22.398fc	4.631ft
1.0m	442.57lx		241.093lx	1.411m
6.562ft	10.279fc		5.600fc	9.261ft
2.0m	110.64lx		60.273lx	2.823m
9.843ft	4.568fc		2.489fc	13.892ft
3.0m	49.175lx		404.483lx	1.134m
13.123ft	2.570fc		1.400fc	18.522ft
4.0m	27.661lx		15.068lx	5.646m
16.404ft	1.645fc		0.896fc	23.153ft
5.0m	17.703lx		9.644lx	7.057m

Illumination Picture (15x70°)

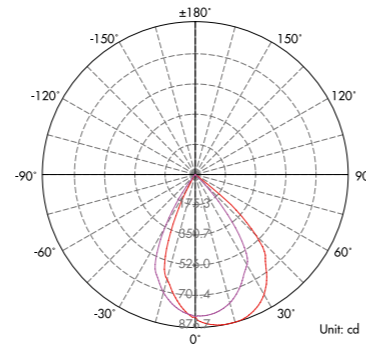


INGROUND LIGHTS SERIES

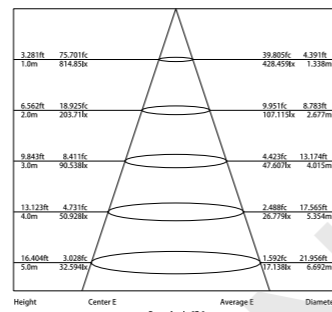


Dimension

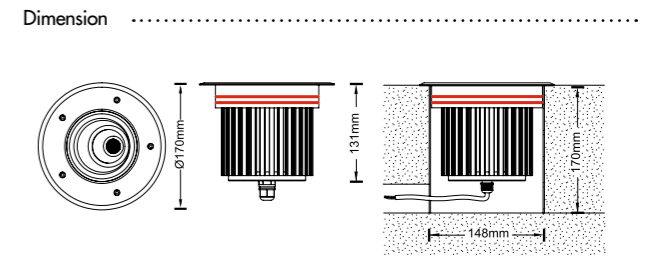
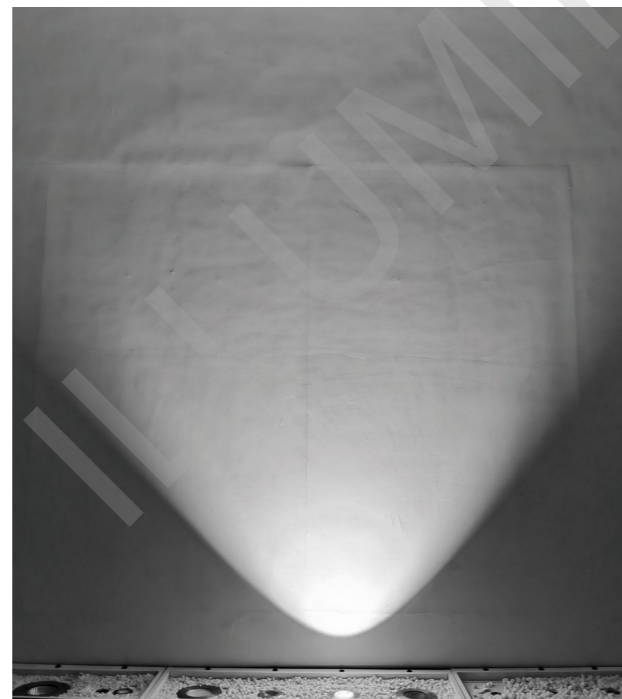
Light Distribution Curve (3000K, 15x70°)



Lux distance Curve (3000K, 15x70°)

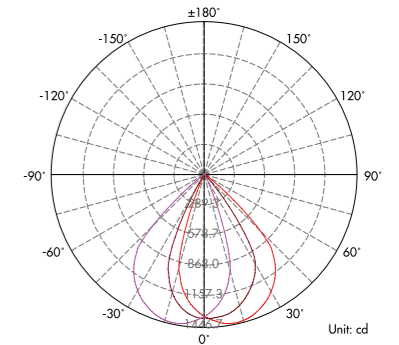


Illumination Picture (15x70°)

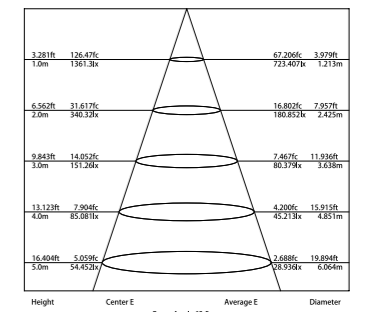


Dimension

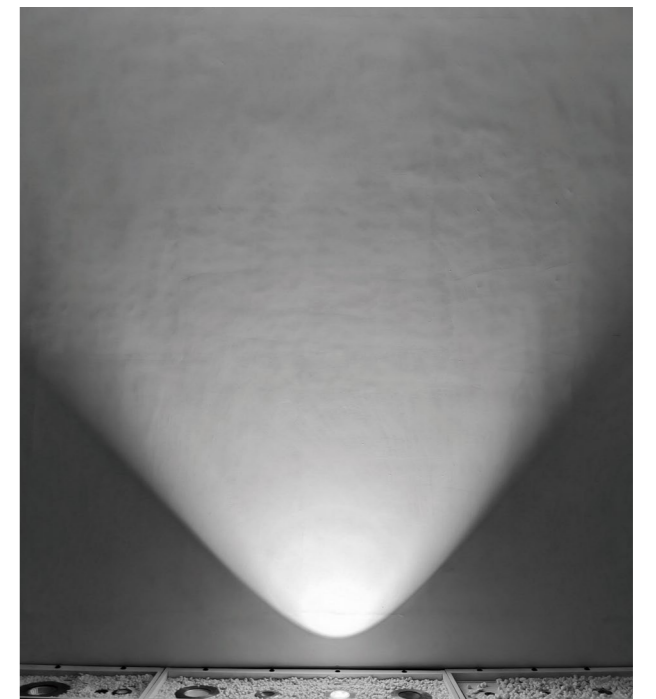
Light Distribution Curve (3000K, 15x70°)



Lux distance Curve (3000K, 15x70°)



Illumination Picture (15x70°)



CE RoHS COMPLIANT IP67 IK09

SSS 316 Passivated 1 Year Warranty

Parameter

General Data	
Item No.	UL-25W-COB-2500-CH
Power	25 Watts
LED type	1PC 25W CREE COB LED
Luminous flux	black reflector: 853~953lm; white reflector: 1280~1380lm
CCT	2700K, 3000K, 4000K, 6000K
CRI	80+
Beam angle	15x70°
Dimension	Ø130x107 (mm) Diameter x length
Cut out	153 mm
Net weight	3.7 kgs
Warranty	1 year
Certifications	CE, RoHS
Electrical Data	
Input voltage	AC100-265V
Insulation class	Class I
Cable	1PC rubber cable 1M H05RN-F 3x1mm square
Driver	Built-in high voltage constant current driver with transformer
Construction Data	
IP rating	IP67 Waterproof
IK rating	IK09
Housing	Solid Passivated (Anodizing) Aluminum CNC machined
Protection finishing	20~25µm thickness anodized film for housing. Dark grey
Trim	Stainless steel 316
Glass	Step tempered Glass. T=8mm.
Loading capacity	2000 kgs
Cable Gland	PG9 IP67
Gasket	O-ring PMQ silicone seal
Accessories	
Mounting sleeve	Passivated (Anodizing) Aluminum CNC machined. Dark grey
Packaging	
Inner box size	150*150*155mm
Carton size	32.5*32.5*33.5 cm (8PCS / carton)

CE RoHS COMPLIANT IP67 IK09

SSS 316 Passivated 1 Year Warranty

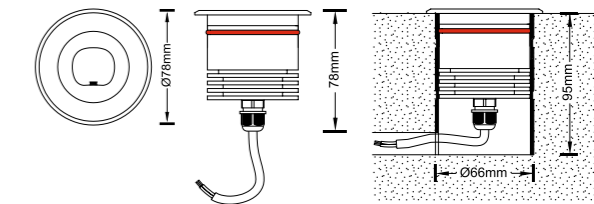
Parameter

General Data	
Item No.	UL-36W-COB-3600-BH
Power	36 Watts
LED type	1PC 36W CREE COB LED
Luminous flux	black reflector: 1230~1300lm; white reflector: 1850~1950lm
CCT	2700K, 3000K, 4000K, 6000K
CRI	80+
Beam angle	15x70°
Dimension	Ø170x131 (mm) Diameter x length
Cut out	153 mm
Net weight	4.1 kgs
Warranty	1 year
Certifications	CE, RoHS
Electrical Data	
Input voltage	DC24V
Insulation class	Class III
Cable	1PC rubber cable 1M H05RN-F 2x1mm square
Driver	Low voltage constant current output, excluding the transformer
Construction Data	
IP rating	IP67 Waterproof
IK rating	IK09
Housing	Solid Passivated (Anodizing) Aluminum CNC machined
Protection finishing	20~25µm thickness anodized film for housing. Dark grey
Trim	Stainless steel 316
Glass	Step tempered Glass. T=10mm.
Loading capacity	2000 kgs
Cable Gland	PG9 IP67
Gasket	O-ring PMQ silicone seal
Accessories	
Mounting sleeve	Passivated (Anodizing) Aluminum CNC machined. Dark grey
Packaging	
Inner box size	178*178*185 mm
Carton size	37.5*37.5*20.5 cm (4PCS / carton)

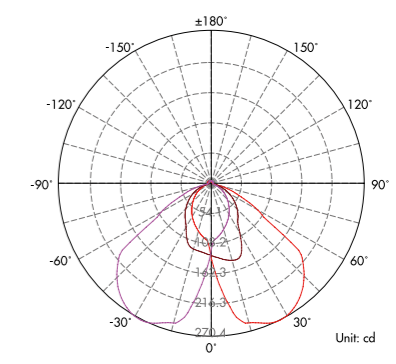




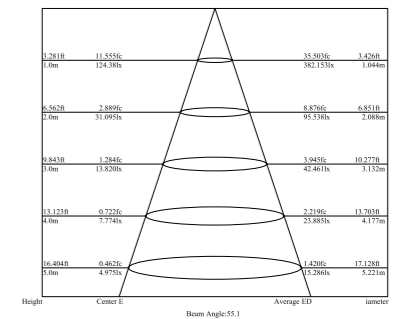
Dimension



Light Distribution Curve (3000K, 30° X 60°)



Lux distance Curve (3000K, 30° X 60°)



Illumination Picture (30° X 60°)



CE RoHS COMPLIANT IP67 IK08

SSS 316 Passivated 1 Year Warranty

Asymmetric Reflector!

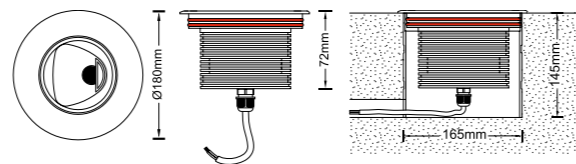
Parameter	
General Data	
Item No.	UL-1013-0700A
Power	7 Watts +10%
LED type	1 PC CREE MHB-A 5050 SMD LED
Luminous flux	460-500lm
CCT	3000K, 4000K, 6000K
CRI	80+
Beam angle	30° tilt asymmetric + 60° pan beam
Dimension	78x78 (mm) Diameter x Height
Cut out	66 mm
Net weight	0.539 kgs
Warranty	1 year
Certifications	CE, RoHS
Electrical Data	
Input voltage	DC24V as standard, (AC100~245V as options)
Insulation class	Class III
Cable	1PC rubber cable 1M H05RN-F 2x1mm square
Driver	Low voltage constant current output, excluding the transformer
Construction Data	
IP rating	IP67 Waterproof
IK rating	IK08
Housing	Solid Passivated (Anodizing) Aluminum CNC machined
Protection finishing	20~25µm thickness anodized film for housing, Dark grey
Trim	Stainless steel 316
Glass	Step tempered Glass, T=6mm.
Loading capacity	2000 kgs
Cable Gland	PG7 IP67
Gasket	O-ring PMQ silicone seal
Accessories	
Mounting sleeve	Passivated (Anodizing) Aluminum CNC machined
Packaging	
Inner box size	85*85*110 mm
Carton size	45*36*13.5 cm (20PCS / carton)

INGROUND LIGHTS SERIES

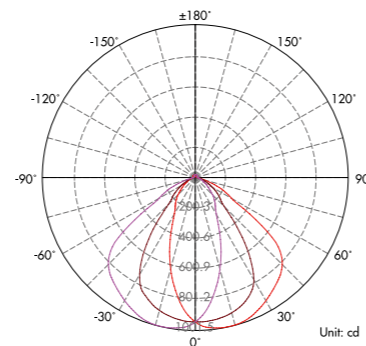


Illustration of downward asymmetrical light
Illustration of general asymmetrical light

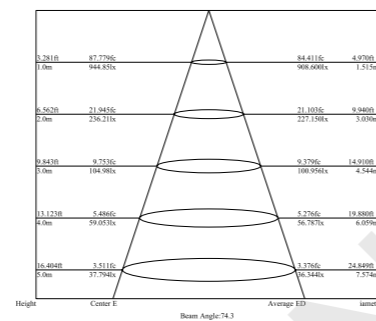
Dimension



Light Distribution Curve (3000K, 15°+60°)



Lux distance Curve (3000K, 15°+60°)



Illumination Picture (15°+60°)



CE RoHS COMPLIANT IP67 IK09

SSS 316 Passivated 1 Year Warranty

Asymmetric Reflector!

Parameter

General Data	
Item No.	UL-30W-COB-3000BH
Power	30 Watts
LED type	1 PC 30W CREE COB LED
Luminous flux	2400~2500 lm
CCT	2700K, 3000K, 4000K, 6000K, R/G/Y/B
CRI	80+
Beam angle	15° tilt asymmetric + 60° pan beam
Dimension	180x72 (mm) Diameter x Height
Cut out	165 mm
Net weight	3.535 kgs
Warranty	1 year
Certifications	CE, RoHS
Electrical Data	
Input voltage	AC100-240V
Insulation class	Class I
Cable	1PC rubber cable 1M H05RN-F 3x1mm square
Driver	Built-in high voltage constant current driver with transformer
Construction Data	
IP rating	IP67 Waterproof
IK rating	IK09
Housing	Solid Passivated (Anodizing) Aluminum CNC machined
Protection finishing	20~25µm thickness anodized film for housing, Dark grey
Trim	Stainless steel 316
Glass	Step tempered Glass, T=10mm.
Loading capacity	2000 kgs
Cable Gland	PG7 IP67
Gasket	O-ring PMQ silicone seal
Accessories	
Mounting sleeve	PVC
Packaging	
Inner box size	190*190*160 mm
Carton size	40*40*18.5 cm (4PCS / carton)





ILLUMINATING ASIA



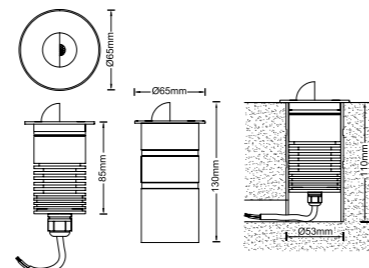
CE RoHS COMPLIANT IP67 IK08

SSS 316 Passivated 1 Year Warranty

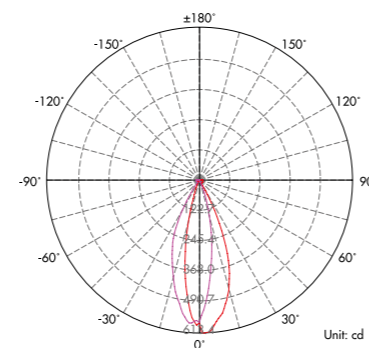
Parameter

General Data	
Item No.	UL-6W-COB-0600-CH (HOOD TRIM)
Power	6 Watts
LED type	1 PC 6W COB LED
Luminous flux	234-300 lm
CCT	2700K, 3000K, 4000K, 6000K
CRI	80+
Beam angle	24°, 36°
Dimension	Ø65x85 (mm) Diameter x length
Cut out	53 mm
Net weight	0.62 kgs
Warranty	1 year
Certifications	CE, RoHS
Electrical Data	
Input voltage	AC100~245V as standard (DC24V as options)
Insulation class	Class I
Cable	1PC rubber cable 1M H05RN-F 3x1mm square
Driver	Built-in high voltage constant current driver with transformer
Construction Data	
IP rating	IP67 Waterproof
IK rating	IK08
Housing	Solid Passivated (Anodizing) Aluminum CNC machined
Protection finishing	20~25µm thickness anodized film for housing. Dark grey
Trim	Stainless steel 316
Glass	Step tempered Glass. T=6mm.
Loading capacity	2000 kgs
Cable Gland	PG9 IP67
Gasket	O-ring PMQ silicone seal
Accessories	
Mounting sleeve	Passivated (Anodizing) Aluminum CNC machined. Dark grey
Packaging	
Inner box size	117*117*105 mm
Carton size	49*25*23.5 cm (16PCS / carton)

Dimension



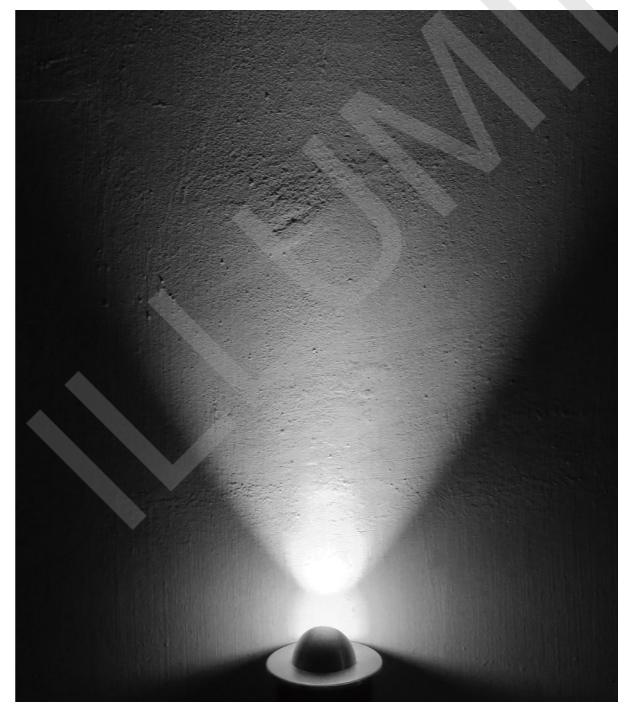
Light Distribution Curve (3000K, 1x24°)



Lux distance Curve (3000K, 1x24°)

Height	Center E	Beam Angle: 31.9	Average E Diameter
3.281ft	53.069ftc		32.999ft 1.873ft
1.0m	571.23lx		355.200lx 0.571m
6.562ft	13.267ftc		18.079ft 3.948ft
2.0m	142.81lx		194.603lx 1.203m
9.843ft	5.897ftc		8.035ft 5.922ft
3.0m	63.470lx		86.490lx 1.805m
13.123ft	3.317ftc		4.520ft 7.897ft
4.0m	35.702lx		48.651lx 2.407m
16.404ft	2.123ftc		2.893ft 9.871ft
5.0m	22.849lx		31.136lx 3.009m

Illumination Picture (1x24°)



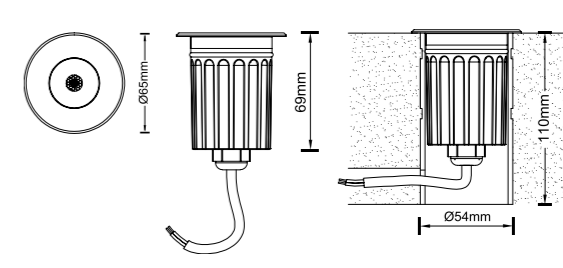
CE RoHS COMPLIANT IP67 IK08

SSS 316 Passivated 1 Year Warranty

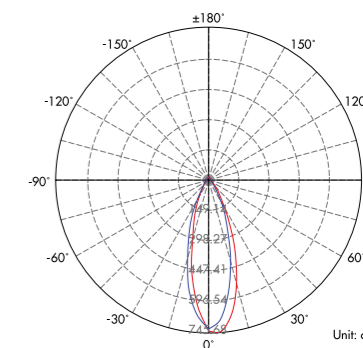
Parameter

General Data	
Item No.	UL-6W-COB-0600F (Half glass black)
Power	6 Watts
LED type	1 PC 6W COB LED
Luminous flux	260~285 lm
CCT	2700K, 3000K, 4000K, 6000K
CRI	80+
Beam angle	24°, 36°
Dimension	Ø65x69 (mm) Diameter x length
Cut out	54 mm
Net weight	0.45 kgs
Warranty	1 year
Certifications	CE, RoHS
Electrical Data	
Input voltage	DC24V
Insulation class	Class III
Cable	1PC rubber cable 1M H05RN-F 2x1mm square
Driver	Low voltage constant current output, excluding the transformer
Construction Data	
IP rating	IP67 Waterproof
IK rating	IK08
Housing	Solid Passivated (Anodizing) Aluminum CNC machined
Protection finishing	20~25µm thickness anodized film for housing. Dark grey
Trim	Stainless steel 316
Glass	Step tempered Glass. T=6mm.
Loading capacity	2000 kgs
Cable Gland	PG7 IP67
Gasket	O-ring PMQ silicone seal
Accessories	
Mounting sleeve	Passivated (Anodizing) Aluminum CNC machined Dark grey
Packaging	
Inner box size	117*117*105 mm
Carton size	49*25*23.5cm (16PCS / carton)

Dimension



Light Distribution Curve (3000K, 1x36°)



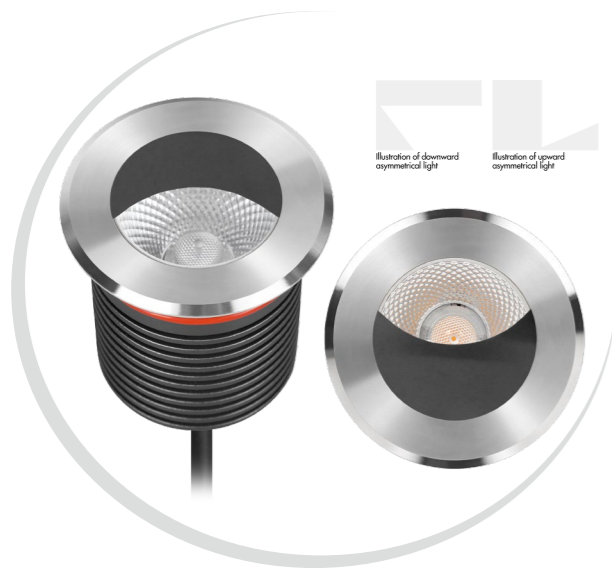
Lux distance Curve (3000K, 1x36°)

Height	Center E	Beam Angle: 36.0	Average E Diameter
2m	182.33 LUX		1.2m 1.2m
4m	45.58 LUX		2.3m 2.4m
6m	20.26 LUX		3.5m 3.6m
8m	11.40 LUX		4.7m 4.8m
10m	7.29 LUX		5.8m 6.0m
12m	5.06 LUX		7.0m 7.2m

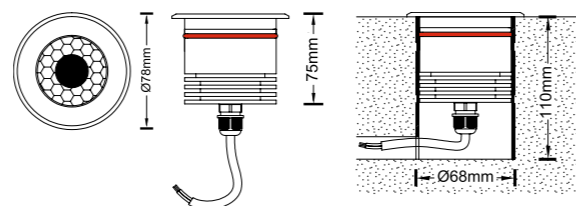
Vert.Spread:32.5 Horiz.Spread:33.2

Illumination Picture (1x36°)

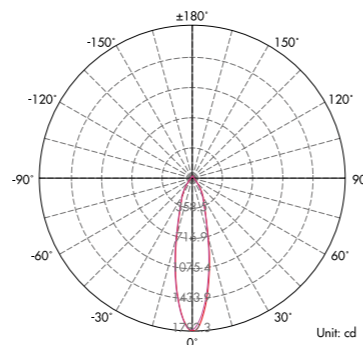




Dimension



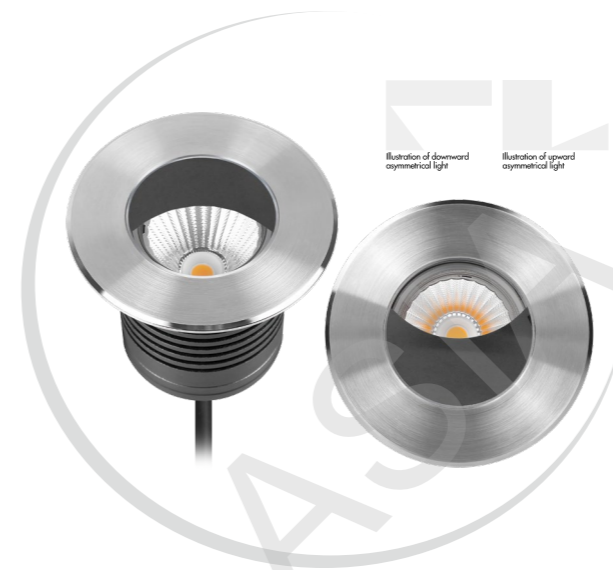
Light Distribution Curve (3000K, 1x40°)



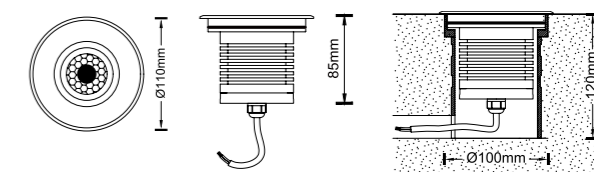
Lux distance Curve (3000K, 1x40°)

Height	Center E	Beam Angle: 25.9	Average E	Diameter
3.281ft	165.54ft		240.297ft	1.510ft
1.0m	1781.9ft		2586.558ft	0.460m
6.562ft	41.385ft		60.074ft	3.020ft
2.0m	445.47ft		646.640ft	0.921m
9.843ft	18.393ft		26.700ft	4.530ft
3.0m	197.99ft		287.395ft	1.381m
13.123ft	10.346ft		15.019ft	6.040ft
4.0m	111.37ft		161.660ft	1.841m
16.404ft	6.622ft		9.612ft	7.550ft
5.0m	71.275ft		103.462ft	2.301m

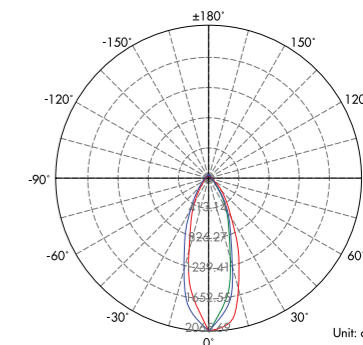
Illumination Picture (1x40°)



Dimension



Light Distribution Curve (3000K, 1x25°)

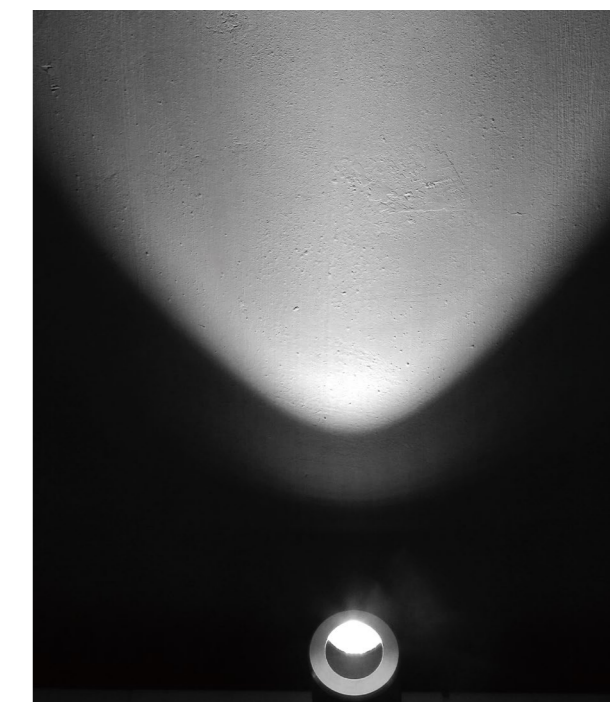


Lux distance Curve (3000K, 1x25°)

2m	511.69 LUX	1.4m	1.3m
4m	127.92 LUX	2.7m	2.6m
6m	56.85 LUX	4.1m	3.9m
8m	31.98 LUX	5.4m	5.2m
10m	20.47 LUX	6.8m	6.6m
12m	14.21 LUX	8.2m	7.9m

Vert.Spread:37.6 Horiz.Spread:36.3

Illumination Picture (38°)



CE RoHS COMPLIANT IP67 IK08

SSS 316 Passivated 1 Year Warranty

Parameter

General Data	
Item No.	UL-9W-COB-0900B(Half glass black)
Power	9 Watts
LED type	1 PC 9W COB LED
Luminous flux	390-420 lm
CCT	2700K, 3000K, 4000K, 6000K
CRI	80+
Beam angle	10°, 23°, 38°
Dimension	Ø78x75 (mm) Diameter x length
Cut out	66 mm
Net weight	0.538 kgs
Warranty	1 year
Certifications	CE, RoHS
Electrical Data	
Input voltage	DC24V as standard, (AC100~245V as options)
Insulation class	Class III
Cable	1PC rubber cable 1M H05RN-F 2x1mm square
Driver	Low voltage constant current output, excluding the transformer
Construction Data	
IP rating	IP67 Waterproof
IK rating	IK08
Housing	Solid Passivated (Anodizing) Aluminum CNC machined
Protection finishing	20~25µm thickness anodized film for housing. Dark grey
Trim	Stainless steel 316
Glass	Step tempered Glass. T=8mm.
Loading capacity	2000 kgs
Cable Gland	PG7 IP67
Gasket	O-ring PMQ silicone seal
Accessories	
Mounting sleeve	Passivated (Anodizing) Aluminum CNC machined. Dark grey
Packaging	
Inner box size	85*85*110 mm
Carton size	45*36*13.5 cm (20PCS / carton)

CE RoHS COMPLIANT IP67 IK09

SSS 316 Passivated 1 Year Warranty

Parameter

General Data	
Item No.	UL-15W-COB-1500-AH (Half glass black)
Power	1.5 Watts
LED type	1 PC 1.5W COB LED
Luminous flux	755-800 lm
CCT	2700K, 3000K, 4000K, 6000K
CRI	80+
Beam angle	15°, 23°, 38°, 45°, 60°
Dimension	Ø110x85 (mm) Diameter x length
Cut out	100 mm
Net weight	0.955 kgs
Warranty	1 year
Certifications	CE, RoHS
Electrical Data	
Input voltage	AC100~265V
Insulation class	Class I
Cable	1PC rubber cable 1M H05RN-F 3x1mm square
Driver	Built-in high voltage constant current driver with transformer
Construction Data	
IP rating	IP67 Waterproof
IK rating	IK09
Housing	Solid Passivated (Anodizing) Aluminum CNC machined
Protection finishing	20~25µm thickness anodized film for housing. Dark grey
Trim	Stainless steel 316
Glass	Step tempered Glass. T=10mm.
Loading capacity	2000 kgs
Cable Gland	PG9 IP67
Gasket	O-ring PMQ silicone seal
Accessories	
Mounting sleeve	Anti-corrosion grey PVC+dark grey Aluminium ring
Packaging	
Inner box size	113*113*132 mm
Carton size	47*24.5*28 cm (16PCS / carton)

INGROUND LIGHTS SERIES

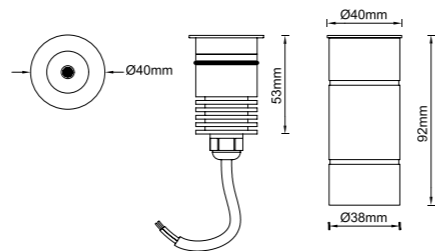
1.8 DEPTH ILLUMINANT ANTI-GLARE GROUND SPOT SERIES



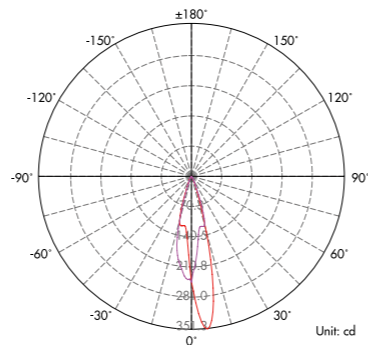
Deep 3W



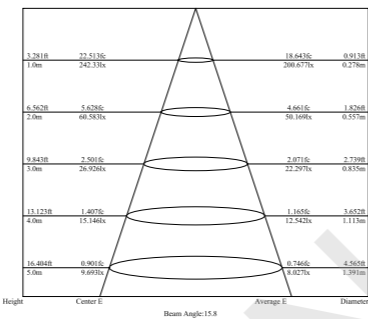
Dimension



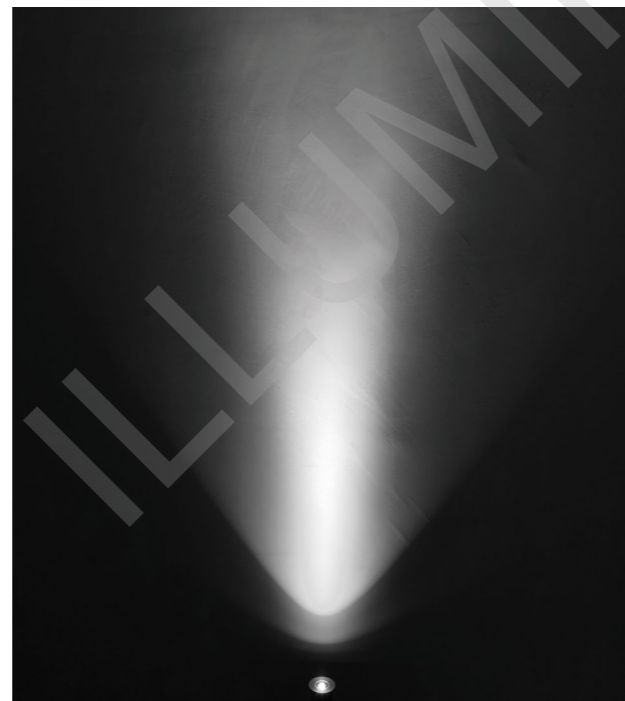
Light Distribution Curve (3000K,35°)



Lux distance Curve (3000K,35°)



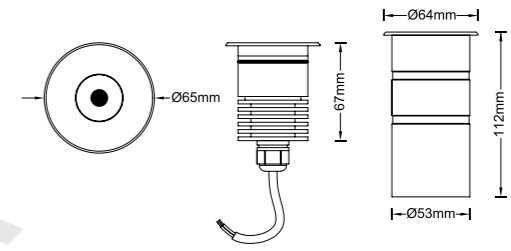
Illumination Picture (35°)



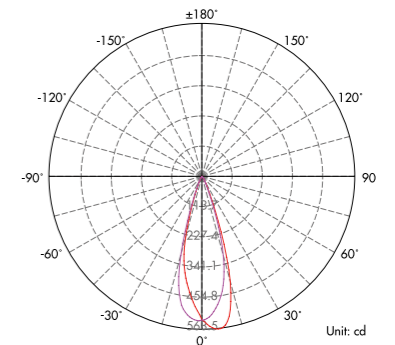
Deep 5W



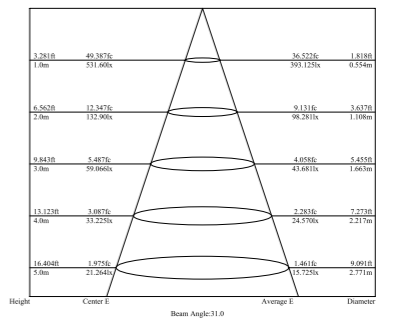
Dimension



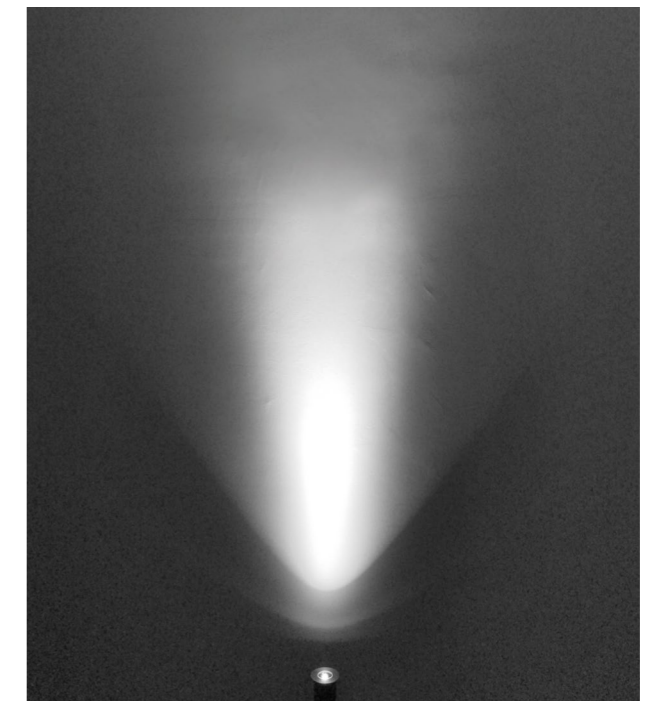
Light Distribution Curve (3000K,35°)



Lux distance Curve (3000K,35°)



Illumination Picture (35°)



CE RoHS COMPLIANT IP67 IK06

SSS 316 1 Year Warranty

Parameter

General Data	
Item No.	UL-1026-0300-A
Power	3 Wwatts ± 10%
LED type	1 PC 3W OSRAM 3030 LED
Luminous flux	60lm ± 10%
CCT	2700K, 3000K, 4000K, 6000K
CRI	80+
Beam angle	35°
Dimension	Ø40x53 (mm) Diameter x length
Cut out	Ø38 (mm)
Net weight	0.35 kgs
Warranty	1 year
Certifications	CE, RoHS
Electrical Data	
Input voltage	DC 12V-DC24V
Insulation class	Class III
Cable	1PC rubber cable 1M H05RN-F 2x1mm square
Driver	Low constant voltage input driver, constant current output for LEDs
Construction Data	
IP rating	IP67 Waterproof
IK rating	IK06
Housing	Solid Passivated (Anodizing) Aluminum CNC machined
Protection finishing	20~25µm thickness anodized film for housing. Dark grey
Trim	Stainless steel 316
Glass	Step tempered Glass. T=4mm.
Loading capacity	300 kgs
Cable Gland	PG gland
Gasket	O-ring PMQ silicone seal
Accessories	
Mounting Sleeve	Passivated (Anodizing) Aluminum CNC machined. Dark grey
Packaging	
Inner box size	110*85*60 mm
Carton size	44*24*32 cm (50 PCS / carton)

CE RoHS COMPLIANT IP67 IK06

SSS 316 1 Year Warranty

Parameter

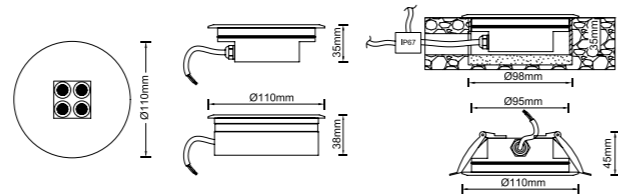
General Data	
Item No.	UL-1026-0500-A
Power	4.5 Wwatts ± 10%
LED type	1 PC CREE XPG LED
Luminous flux	150lm ± 10%
CCT	2700K, 3000K, 4000K, 6000K
CRI	80+
Beam angle	35°
Dimension	Ø64x67 (mm) Diameter x length
Cut out	Ø53 (mm)
Net weight	0.45 kgs
Warranty	1 year
Certifications	CE, RoHS
Electrical Data	
Input voltage	DC 12V-DC24V
Insulation class	Class III
Cable	1PC rubber cable 1M H05RN-F 2x1mm square
Driver	Low constant voltage input driver, constant current output for LEDs
Construction Data	
IP rating	IP67 Waterproof
IK rating	IK06
Housing	Solid Passivated (Anodizing) Aluminum CNC machined
Protection finishing	20~25µm thickness anodized film for housing. Dark grey
Trim	Stainless steel 316
Glass	Step tempered Glass. T=6mm.
Loading capacity	300 kgs
Cable Gland	PG gland
Gasket	O-ring PMQ silicone seal
Accessories	
Mounting Sleeve	Passivated (Anodizing) Aluminum CNC machined. Dark grey
Packaging	
Inner box size	130*115*80 mm
Carton size	36.5*28*26 cm (18 PCS / carton)



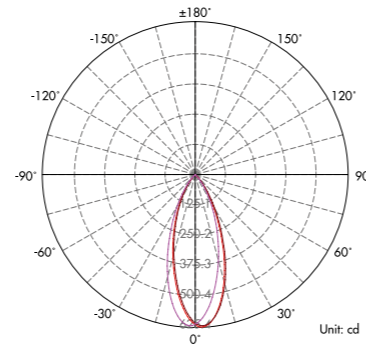
Slim Deep 6W



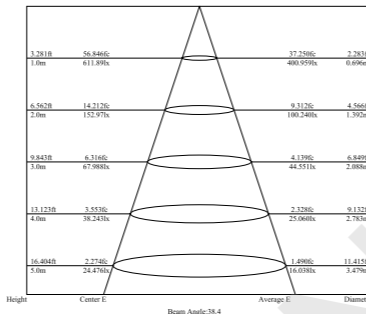
Dimension



Light Distribution Curve (3000K,40°)



Lux distance Curve (3000K,40°)



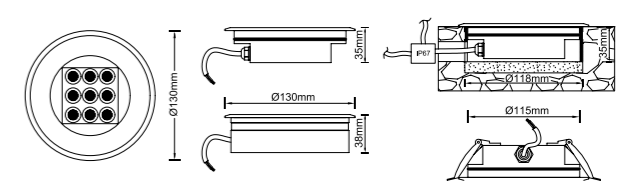
Illumination Picture (40°)



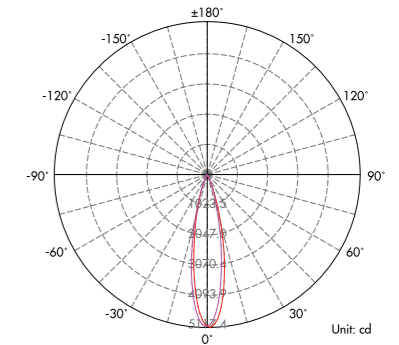
Slim Deep 12W



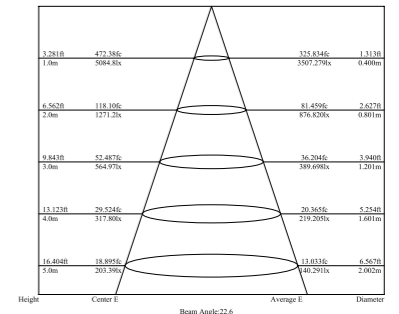
Dimension



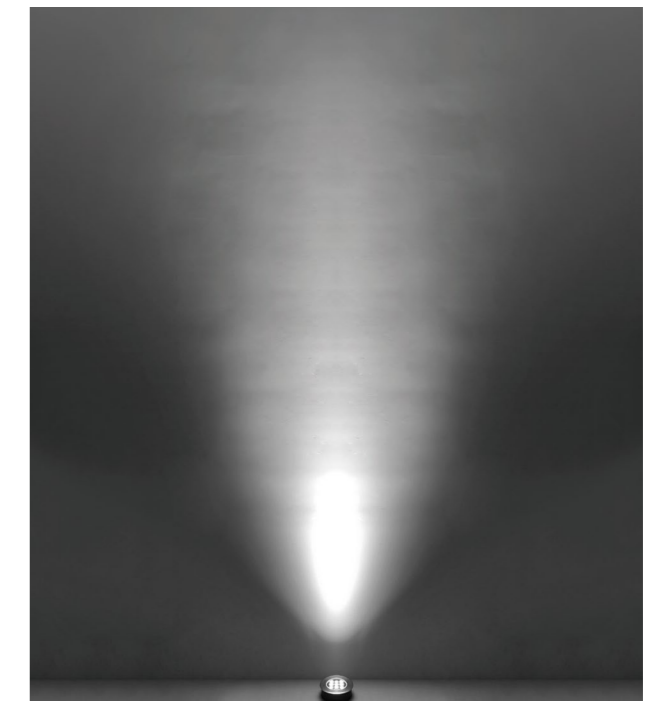
Light Distribution Curve (3000K,24°)



Lux distance Curve (3000K,24°)



Illumination Picture (24°)



CE RoHS COMPLIANT IP67 IK08

SSS 316 1 Year Warranty

Used as inground lights, downlights, deck lights!

Parameter

General Data	
Item No.	UL-4001-0600-E
Power	6 Watts ± 10%
LED type	4 PCS 1.5V OSRAM 3030 LED
Luminous flux	500lm ± 10%
CCT	2700K, 3000K, 4000K, 6000K
CRI	80+
Beam angle	15°, 24°, 40°
Dimension	Ø110x35 (mm) Diameter x length
Cut out	98 mm with sleeve, 95mm with clip
Net weight	0.58 kgs
Warranty	1 year
Certifications	CE, RoHS
Electrical Data	
Input voltage	DC24V
Insulation class	Class III
Cable	1PC rubber cable 1M H05RN-F 2x1mm square
Driver	Low constant voltage input driver, constant current output for LEDs
Construction Data	
IP rating	IP67 Waterproof
IK rating	IK08
Housing	Solid Passivated (Anodizing) Aluminum CNC machined
Protection finishing	20~25µm thickness anodized film for housing. Dark grey
Trim	Stainless steel 316
Glass	Step tempered Glass, T=8mm.
Loading capacity	500 kgs
Cable Gland	PG gland
Gasket	O-ring PMQ silicone seal
Accessories	
Mounting Sleeve	Passivated (Anodizing) Aluminum CNC machined. Dark grey
Clip	With spring as options, that's for wall lights, deck lights or ceiling lights application
Packaging	
Inner box size	120*120*60 mm
Carton size	38.5*26.5*20.5 cm (18 PCS / carton)

CE RoHS COMPLIANT IP67 IK08

SSS 316 1 Year Warranty

Used as inground lights, downlights, deck lights!

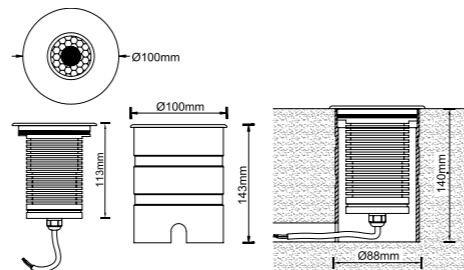
Parameter

General Data	
Item No.	UL-9001-1200-E
Power	12 Watts ± 10%
LED type	9 PCS 1.3V OSRAM 3030 LED
Luminous flux	1000lm ± 10%
CCT	2700K, 3000K, 4000K, 6000K
CRI	80+
Beam angle	15°, 24°, 40°
Dimension	Ø130x35 (mm) Diameter x length
Cut out	118 mm with sleeve, 115mm with clip
Net weight	0.75 kgs
Warranty	1 year
Certifications	CE, RoHS
Electrical Data	
Input voltage	DC24V
Insulation class	Class III
Cable	1PC rubber cable 1M H05RN-F 2x1mm square
Driver	Low constant voltage input driver, constant current output for LEDs
Construction Data	
IP rating	IP67 Waterproof
IK rating	IK08
Housing	Solid Passivated (Anodizing) Aluminum CNC machined
Protection finishing	20~25µm thickness anodized film for housing. Dark grey
Trim	Stainless steel 316
Glass	Step tempered Glass, T=8mm.
Loading capacity	500 kgs
Cable Gland	PG gland
Gasket	O-ring PMQ silicone seal
Accessories	
Mounting Sleeve	Passivated (Anodizing) Aluminum CNC machined. Dark grey
Clip	With spring as options, that's for wall lights, deck lights or ceiling lights application
Packaging	
Inner box size	140*140*60 mm
Carton size	30.5*30.5*20.5 cm (12 PCS / carton)

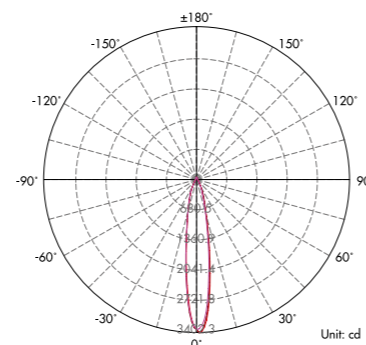




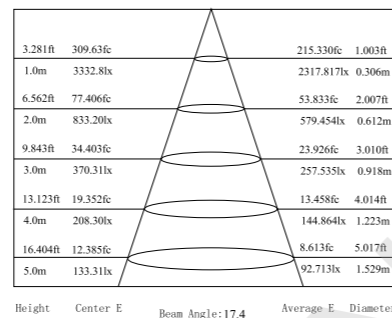
Dimension



Light Distribution Curve (3000K,15°)



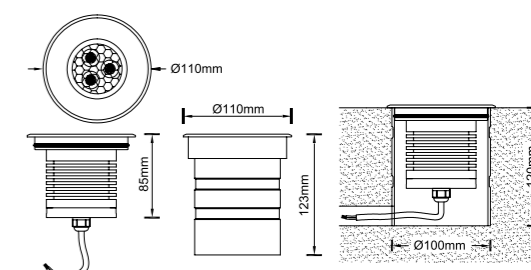
Lux distance Curve (3000K,15°)



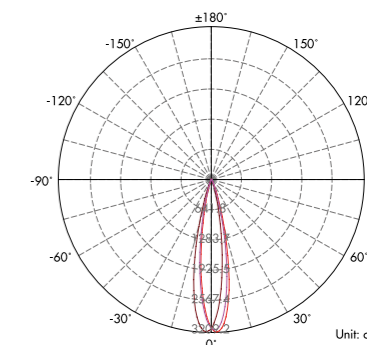
Illumination Picture (15°)



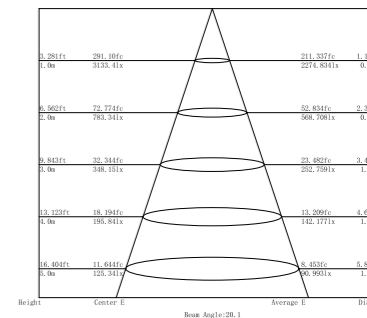
Dimension



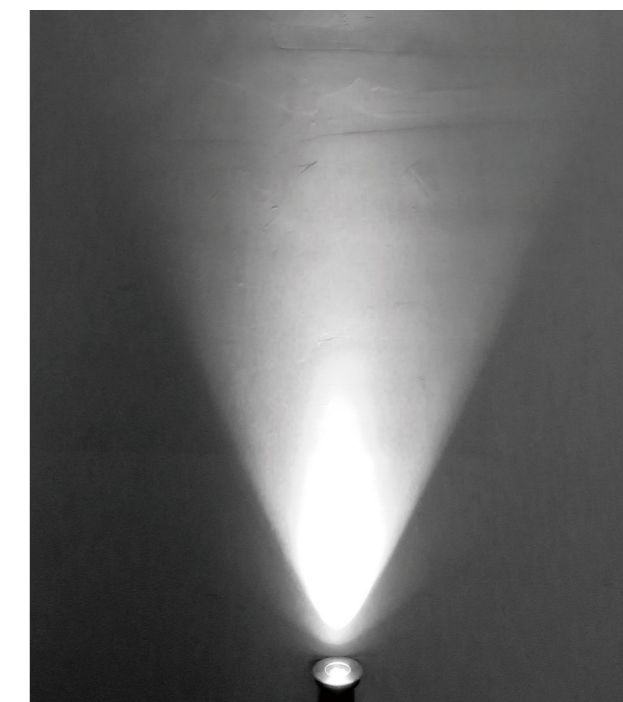
Light Distribution Curve (3000K,25°)



Lux distance Curve (3000K,25°)



Illumination Picture (25°)



CE RoHS COMPLIANT IP67 IK09

Passivated 1 Year Warranty

Parameter

General Data	
Item No.	UL-15W-COB-1500-GH
Power	1.5 Watts
LED type	1 PC 15W CREE COB LED
Luminous flux	510~610 lm
CCT	2700K, 3000K, 4000K, 6000K
CRI	80+
Beam angle	15°
Dimension	Ø100x113 (mm) Diameter x Height
Cut out	Ø88 mm
Net weight	1.2 KGS
Warranty	1 year
Certifications	CE, RoHS
Electrical Data	
Input voltage	AC100~245V
Insulation class	Class I
Cable	1PC rubber cable 1M H05RN-F 3x1mm square
Driver	Built-in high voltage constant current driver with transformer
Construction Data	
IP rating	IP67 Waterproof
IK rating	IK09
Housing	Solid Passivated (Anodizing) Aluminum CNC machined
Protection finishing	20~25µm thickness anodized film for housing. Dark grey color
Trim	Stainless steel 316
Glass	Step tempered Glass. T=8mm.
Loading capacity	2000 kgs
Cable Gland	PG7 IP67
Gasket	O-ring PMQ silicone seal
Accessories	
Mounting sleeve	Aluminium sleeve in dark grey
Packaging	
Inner box size	110*110*145mm
Carton size	35.5*32.5*32.5 cm (12PCS/CTN)

CE RoHS COMPLIANT IP67 IK09

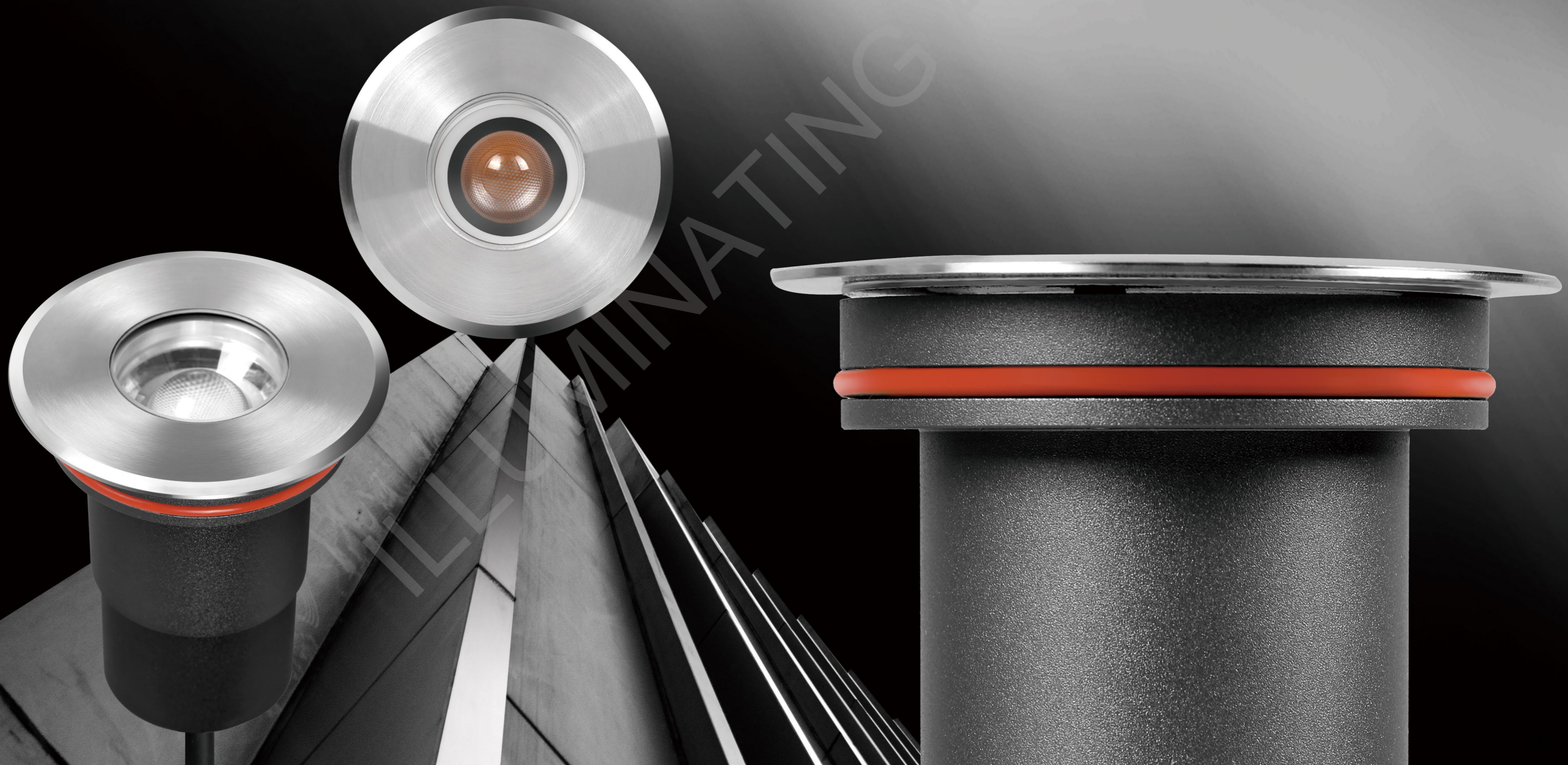
SSS 316 Passivated 1 Year Warranty

Parameter

General Data	
Item No.	UL-3003-1500-BH
Power	1.5 Watts
LED type	3 PCS 5W XPG LED
Luminous flux	600~750 lm
CCT	2700K, 3000K, 4000K, 6000K
CRI	80+
Beam angle	6°, 8°, 10°, 17°, 23°, 28°, 43°, 58° or Asymmetric 1.5°+1.5°, 1.5°+2.5°, 1.5°+3.0°, 1.5°+4.5°, 1.5°+6.0° (tilt +pan)
Dimension	110x85 (mm) Diameter x Height
Cut out	100 mm
Net weight	1.2 kgs
Warranty	1 year
Certifications	CE, RoHS
Electrical Data	
Input voltage	AC100-265V (or DC24V)
Insulation class	Class I
Cable	1PC rubber cable 1M H05RN-F 3x1mm square
Driver	Built-in high voltage constant current driver with transformer
Construction Data	
IP rating	IP67 Waterproof
IK rating	IK09
Housing	Solid Passivated (Anodizing) Aluminum CNC machined
Protection finishing	20~25µm thickness anodized film for housing, Dark grey
Trim	Stainless steel 316
Glass	Step tempered Glass. T=10mm.
Loading capacity	2000 kgs
Cable Gland	PG7 IP67
Gasket	O-ring PMQ silicone seal
Accessories	
Mounting sleeve	Passivated (Anodizing) Aluminum CNC machined. Dark grey
Packaging	
Inner box size	113*113*132 mm
Carton size	47*24.5*28 cm (16PCS / carton)

INGROUND LIGHTS SERIES

1.9 ZOOMABLE COB LED GROUND SPOT SERIES





CE RoHS COMPLIANT IP67 IK08

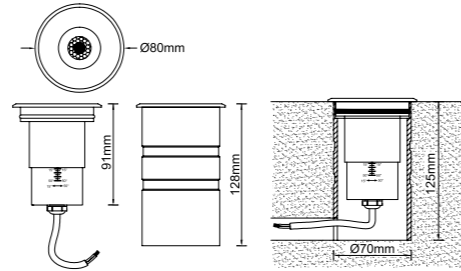
SSS 316 Passivated 1 Year Warranty

Zoomable!

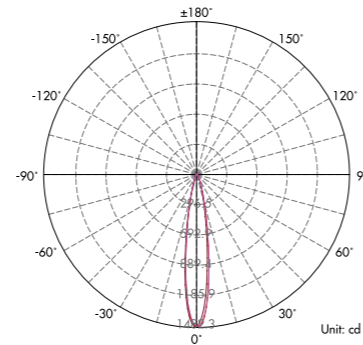
Parameter

General Data	
Item No.	UL-8W-COB-0800J
Power	8 Watts (1.5W, 25W versions coming later)
LED type	1 PC 8W CREE CXA1304 COB LED
Luminous flux	15°: 190-230 lm, 50°: 550-590 lm
CCT	2700K, 3000K, 4000K, 6000K
CRI	80+
Beam angle	Zoomable 15° to 50° adjustable
Dimension	Ø80*128 (mm) Diameter x length
Cut out	70 mm
Net weight	0.8 kgs
Warranty	1 year
Certifications	CE, RoHS
Electrical Data	
Input voltage	DC 12V ~DC24V
Insulation class	Class III
Cable	1PC rubber cable 1M H05RN-F 2x1mm square
Driver	Low voltage constant current driver without transformer
Construction Data	
IP rating	IP67 Waterproof
IK rating	IK07
Housing	Solid Passivated (Anodizing) Aluminum CNC machined
Protection finishing	20-25µm thickness anodized film for housing. Dark grey
Trim	Stainless steel 316
Glass	Step tempered Glass. T=6mm.
Loading capacity	500 kgs
Cable Gland	PG7 IP67
Gasket	O-ring PMQ silicone sea
Accessories	
Mounting sleeve	Passivated (Anodizing) Aluminum CNC machined. Dark grey
Packaging	
Inner box size	150*110*85 mm
Carton size	47.5*35.5*19 cm (18PCS / carton)

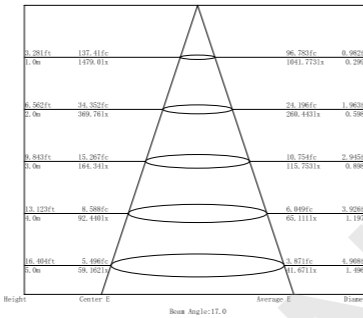
Dimension



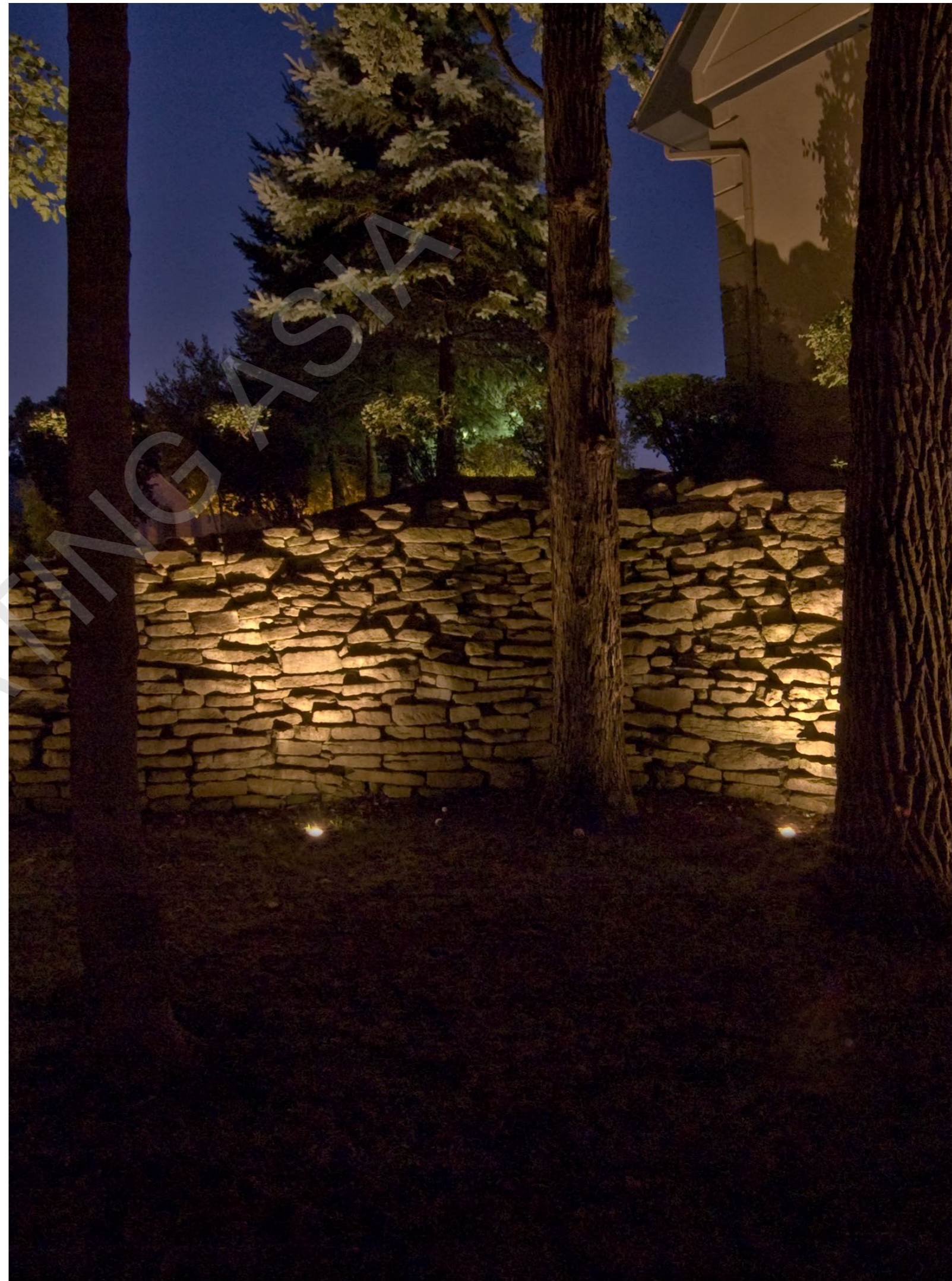
Light Distribution Curve (3000K, 1x15°)



Lux distance Curve (3000K, 1x15°)



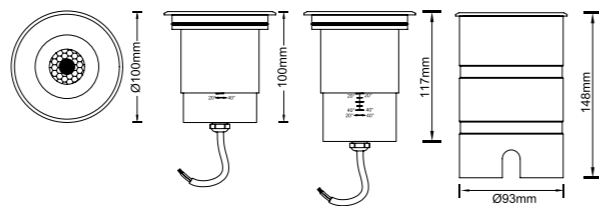
Illumination Picture (1x15°)



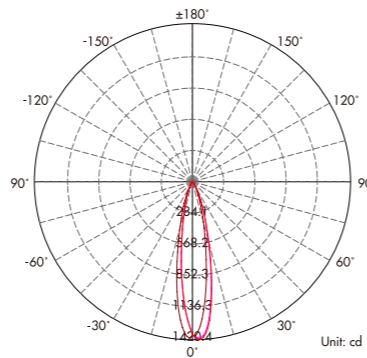
Zoom 15W



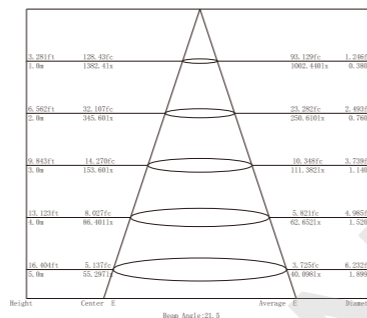
Dimension



Light Distribution Curve (3000K, 20°)



Lux distance Curve (3000K, 20°)



Illumination Picture (20°)



CE RoHS COMPLIANT IP67 IK07

SSS 316 1 Year Warranty

Zoomable beam 20°-40°

Parameter

General Data

Item No.	AC100-265V: UL-15W-COB-1500JH / DC24V:UL-15W-COB-1500J
Power	1.5 Watts +10%
LED type	1PC 15W CREE CXA1507 LED
Luminous flux	20°: 300lm+10% / 40°: 1000lm+10%
CCT	2700K, 3000K, 4000K, 6000K
CRI	80+
Beam angle	Zoomable 20°-40°
Dimension	Ø100x117 (mm) Diameter x length
Cut out	Ø93 mm
Net weight	1 kgs
Warranty	1 year
Certifications	CE, RoHS

Electrical Data

Input voltage	AC100-265V or DC24V optional
Insulation class	Class I or Class III
Cable	1PC rubber cable 1M HO5RN-F 3 or 2x1mm square
Driver	Built-in constant current driver or Low constant voltage input driver, constant current output for LEDs

Construction Data

IP rating	IP67 Waterproof
IK rating	IK07
Housing	Solid Passivated (Anodizing) Aluminum CNC machined
Protection finishing	20~25µm thickness anodized film for housing .Dark grey
Trim	Stainless steel 316
Glass	Step tempered Glass.T=8mm.
Loading capacity	500 kgs
Cable Gland	PG gland
Gasket	O-ring PMQ silicone seal

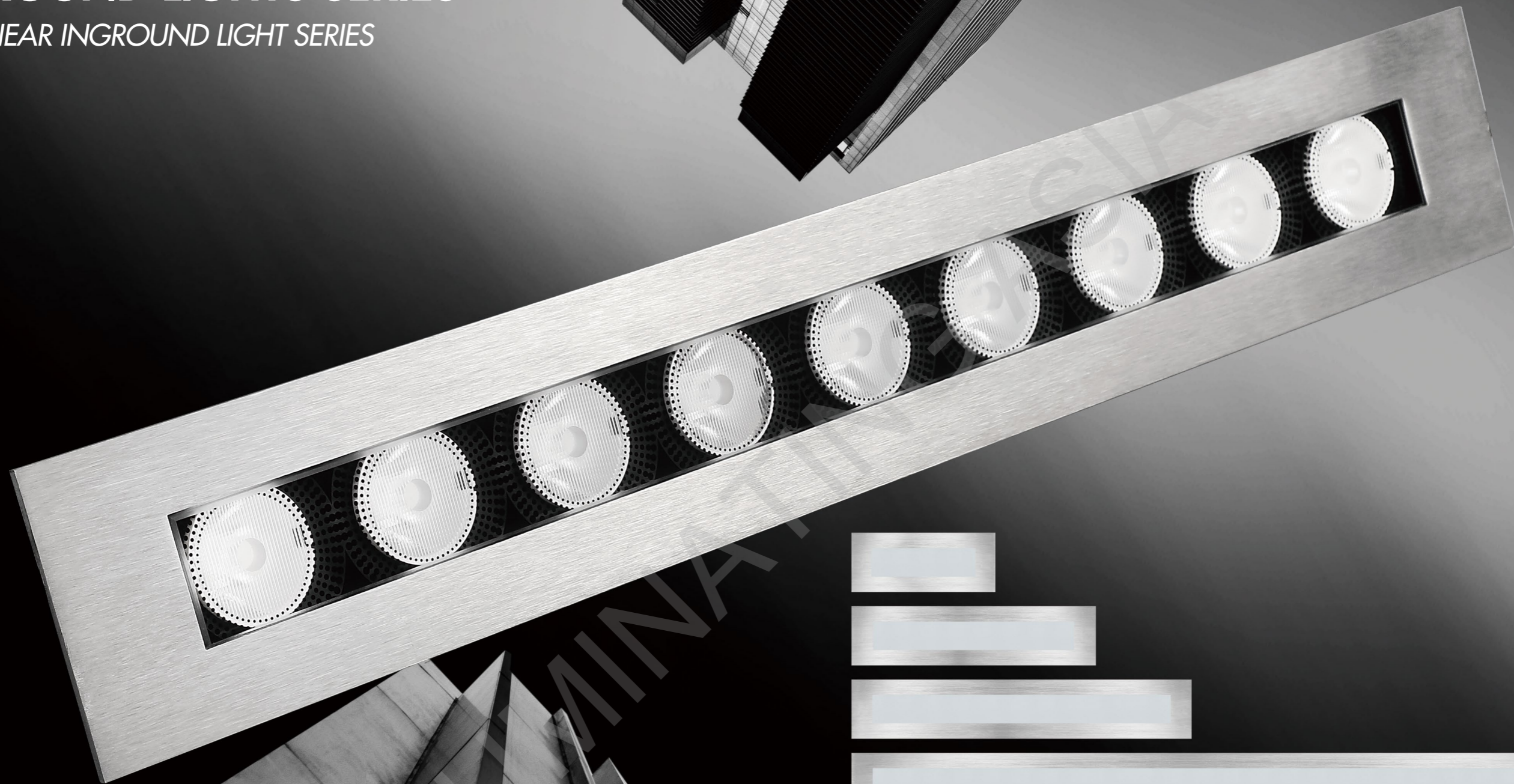
Accessories

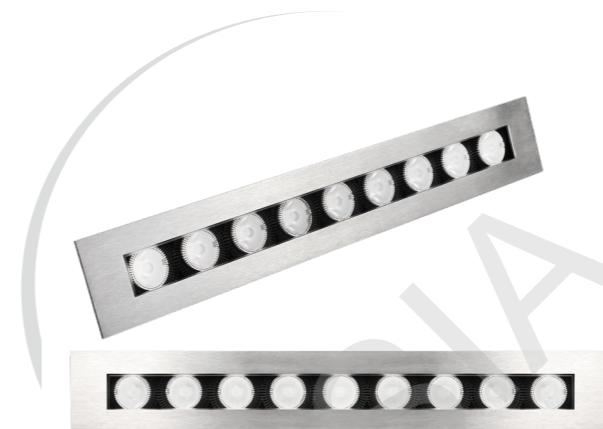
Mounting Sleeve	Passivated (Anodizing) Aluminum CNC machined .Dark grey
Packaging	
Inner box size	150*120*155 mm
Carton size	50*47.5*17.5cm (10 PCS/carton)



INGROUND LIGHTS SERIES

1.10 LINEAR INGROUND LIGHT SERIES





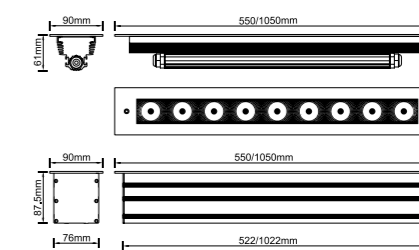
CE RoHS COMPLIANT IP68 IK08

SSS 316 Passivated 1 Year Warranty

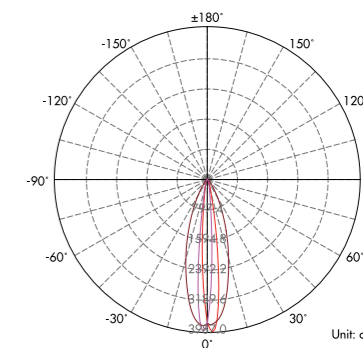
Parameter

General Data	
Item No.	48W: ULCO10-4800-A / 98W: ULCO11-9600-A
Power	48 Watts / 96 Watts
LED type	9 PCS / 18 PCS CREE XPG LED
Luminous flux	1920lm±10% / 3840lm±10%
CCT	2700K, 3000K, 4000K, 6000K, R/G/Y/B
CRI	80+
Beam angle	5°, 8°, 12°, 24°, 36°, 60°, 10°*30°
Dimension	550*90*61 mm / 1050*90*61 mm (L x W x H)
Cut out	/
Net weight	2.52 kgs / 5.2 kgs
Warranty	1 year
Certifications	CE, RoHS
Electrical Data	
Input voltage	DC12V / DC24V (AC100~240V version optional)
Insulation class	Class III
Cable	2 PCS rubber cable 20CM cables
Driver	Low voltage constant current output, excluding the transformer
Control	Stand alone
Construction Data	
IP rating	IP68 Waterproof
IK rating	IK08
Housing	Solid Passivated (Anodizing) Aluminum CNC machined
Protection finishing	20~25µm thickness anodized film for housing. Dark grey
Trim	stainless steel 316
Glass	Tempered Glass. T=8mm
Loading capacity	2000kgs
Cable Gland	PG9 IP68
Gasket	PMQ silicone gasket seal
Accessories	
Mounting sleeve	Passivated (Anodizing) Aluminum. Dark grey
Packaging	
Inner box size	95*93.5*600 mm / 95*95*1100mm
Carton size	21*62*21cm / 21.5*112.5*21.5 cm (4 PCS/CTN)

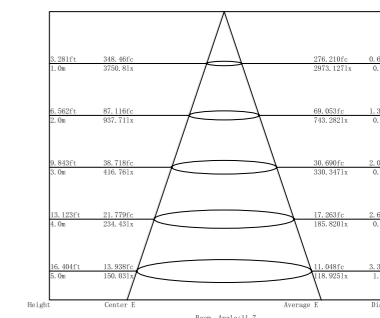
Dimension



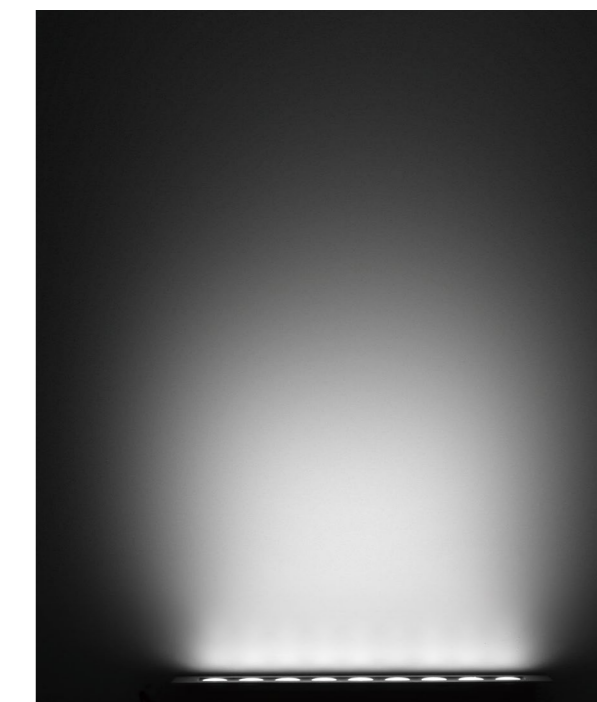
Light Distribution Curve (3000K, 10x30°)



Lux distance Curve (3000K, 10x30°)



Illumination Picture (10x30°)



INGROUND LIGHTS SERIES

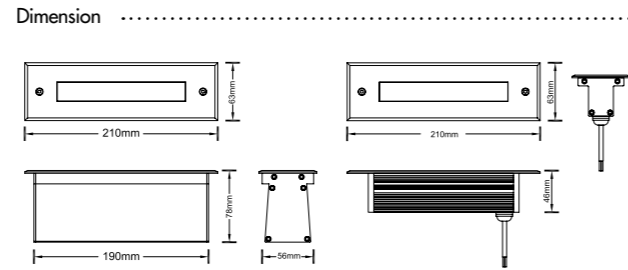


CE RoHS COMPLIANT IP67 IK08

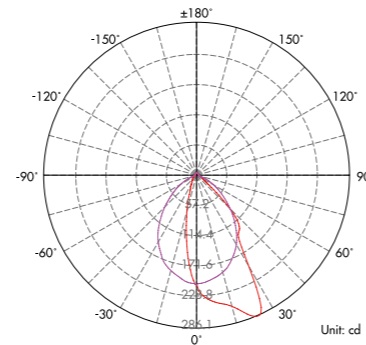
SSS 316 Passivated 1 Year Warranty

Asymmetric lens!

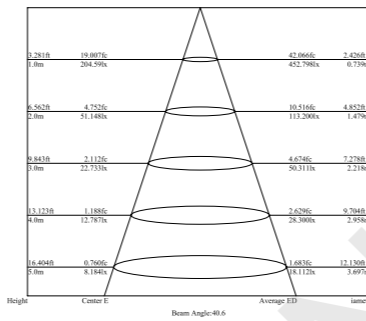
It can be used as inground lights, step lights or wall lights.



Dimension



Light Distribution Curve



Lux distance Curve



Illumination Picture (Assymetrical 30° tilt +120° pan beam)

Parameter

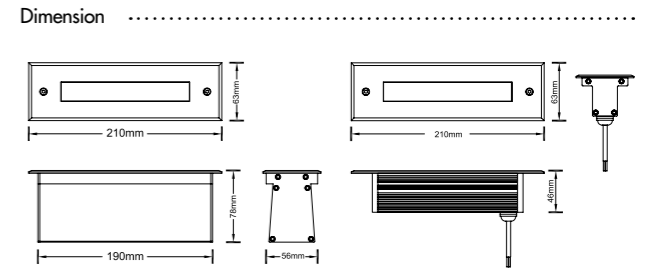
General Data	
Item No.	UL-C001-0700-AH
Power	7.5 Watts
LED type	30 PCS OSRAM 2835 SMD LED
Luminous flux	330~350 lm
CCT	2700K, 3000K, 4000K, 6000K, R/G/Y/B
CRI	80+
Beam angle	Assymetrical 30° tilt +120° pan beam
Dimension	210 x 63 x 78 (mm) Length x Width x Height
Cut out	185 x 57 x 75 (mm) Length x Width x Height
Net weight	1.04 kgs
Warranty	1 year
Certifications	CE, RoHS
Electrical Data	
Input voltage	AC100-255V
Insulation class	Class I
Cable	1 PC rubber cable 1M H05RN-F 3x1mm square
Driver	Builin high voltage constant current driver with transformer
Construction Data	
IP rating	IP67 Waterproof
IK rating	IK08
Housing	Passivated (Anodizing) Aluminum
Protection finishing	20~25µm thickness anodized film for housing. Dark grey
Trim	Stainless steel 316
Glass	Step tempered Glass. T=8mm.
Loading capacity	2000 kgs
Cable Gland	PG9 IP67
Gasket	O-ring PMQ silicone seal
Accessories	
Mounting Sleeve	Passivated (Anodizing) Aluminum CNC machined. Dark grey
Packaging	
Inner box size	220*85*95mm
Carton size	44.5*23.5*21 cm (10PCS / carton)



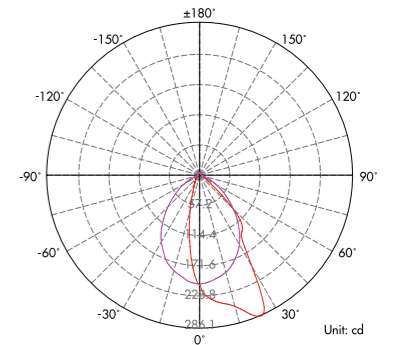
CE RoHS COMPLIANT IP67 IK08

SSS 316 Passivated 1 Year Warranty

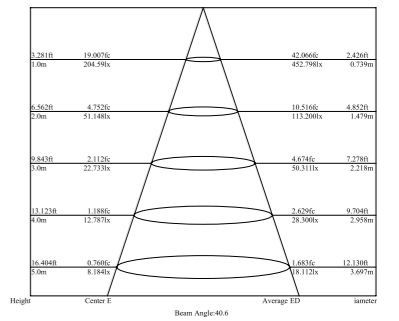
It can be used as inground lights, step lights or wall lights.



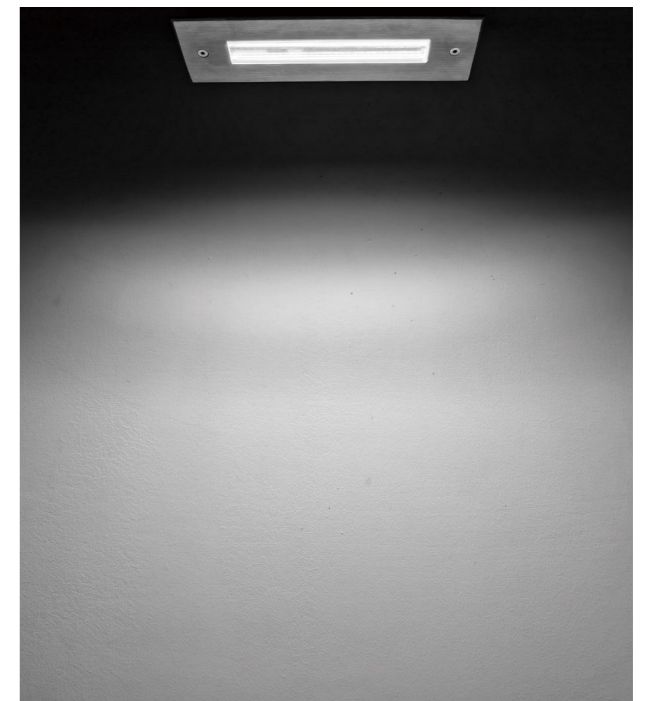
Dimension



Light Distribution Curve



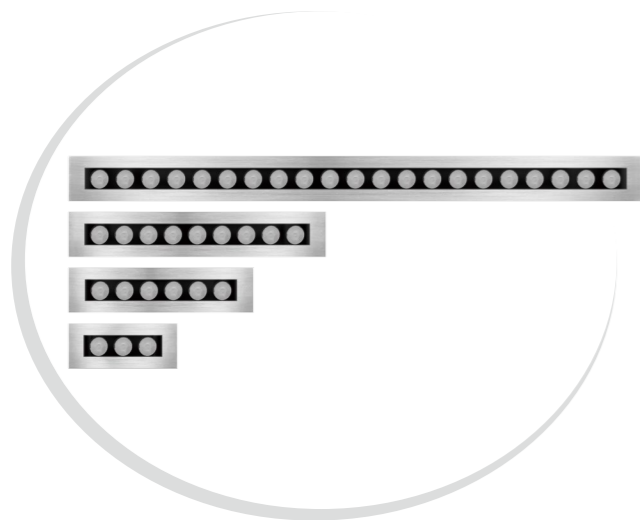
Lux distance Curve



Illumination Picture (Assymetrical 30° tilt +120° pan beam)

Parameter

General Data	
Item No.	UL-C001-0700-AH (frosted glass)
Power	7.5 Watts
LED type	30 PCS OSRAM 2835 SMD LED
Luminous flux	220~250lm
CCT	2700K, 3000K, 4000K, 6000K, R/G/Y/B
CRI	80+
Beam angle	120°
Dimension	210 x 63 x 78 (mm) Length x Width x Height
Cut out	185 x 57 x 75 (mm) Length x Width x Height
Net weight	1.04 kgs
Warranty	1 year
Certifications	CE, RoHS
Electrical Data	
Input voltage	AC100-255V
Insulation class	Class I
Cable	1 PC rubber cable 1M H05RN-F 3x1mm square
Driver	Builin high voltage constant current driver with transformer
Construction Data	
IP rating	IP67 Waterproof
IK rating	IK08
Housing	Passivated(Anodizing) Aluminum
Protection finishing	20~25µm thickness anodized film for housing. Dark grey
Trim	Passivated(Anodizing) Aluminum
Glass	Step tempered Glass. T=8mm.
Loading capacity	200 kgs
Cable Gland	PG9 IP67
Gasket	O-ring PMQ silicone seal
Accessories	
Mounting Sleeve	Passivated (Anodizing) Aluminum CNC machined. Dark grey
Packaging	
Inner box size	220*85*95mm
Carton size	44.5*23.5*21 cm (10PCS / carton)

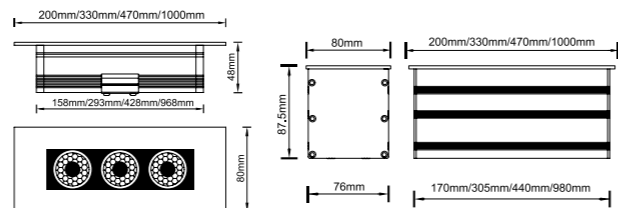


CE RoHS COMPLIANT IP67 IK08

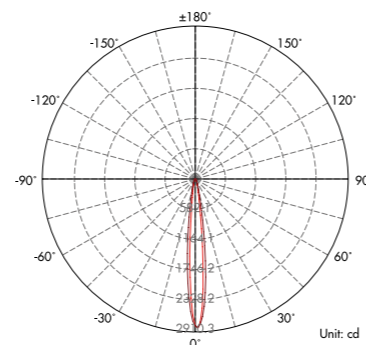
SSS 316 1 Year Warranty

Used as step lights, inground lights !

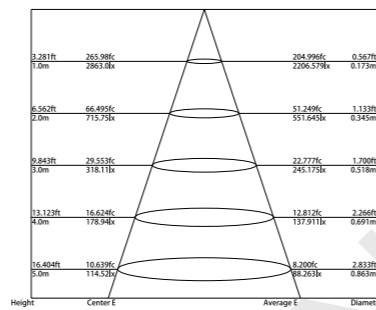
Dimension



Light Distribution Curve (3000K,7W,10x30°)



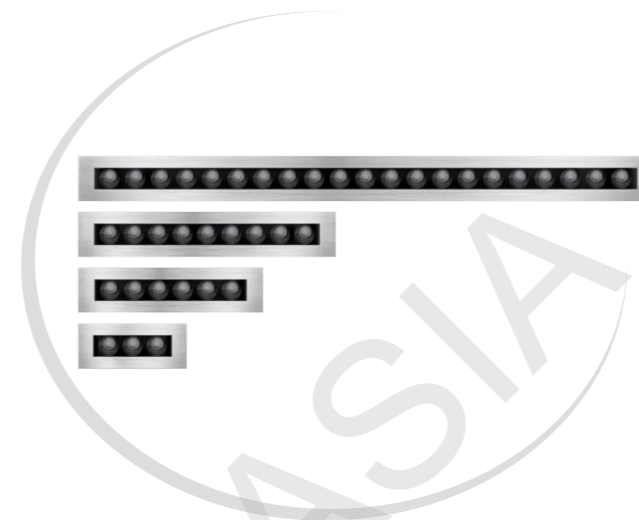
Lux distance Curve (3000K,7W,10x30°)



Illumination Picture (10x30°)



General Data	
Item No.	UL-C012-0700A / UL-C012-1400A / UL-C012-2100A / UL-C012-4900A
Power	7W / 14W / 21W / 49W +10%
LED type	3PCS / 6PCS / 9PCS / 21PCS CREE XPE LED
Luminous flux	350lm / 700lm / 1050lm / 2450lm +10%
CCT	2700K, 3000K, 4000K, 6000K, R,G,Y,B
CRI	80+
Beam angle	5°, 8°, 12°, 24°, 36°, 60°, or oval lens 10°*30°
Dimension	200/330/470/1000x 80 x 87.5 (mm) Length x Width x Height
Cut out	175mm/310mm/445mm/985mm x 80 x 85 (mm) Length x Width x Height
Net weight	/ kgs
Warranty	1 year
Certifications	CE, RoHS
Electrical Data	
Input voltage	DC 12V-DC24V
Insulation class	Class III
Cable	1PC rubber cable 1M H05RN-F 2x1mm square
Driver	Low voltage constant current driver without transformer
Construction Data	
IP rating	IP67 Waterproof
IK rating	IK08
Housing	Passivated(Anodizing) Aluminum
Protection finishing	20~25µm thickness anodized film for housing. Dark grey
Trim	Stainless steel 316
Glass	Step tempered Glass. T=8mm.
Loading capacity	500 kgs
Cable Gland	PG gland
Gasket	PMQ silicone seal
Accessories	
Mounting Sleeve	Passivated (Anodizing) Aluminum. Dark grey
Packaging	
Inner box size	/ mm
Carton size	/ cm (/ PCS / carton)



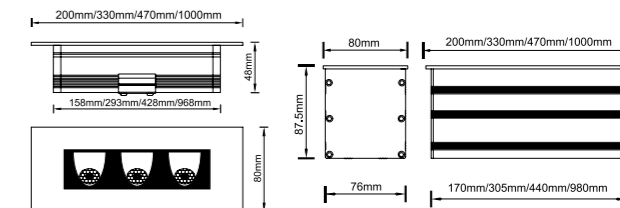
CE RoHS COMPLIANT IP67 IK08

SSS 316 1 Year Warranty

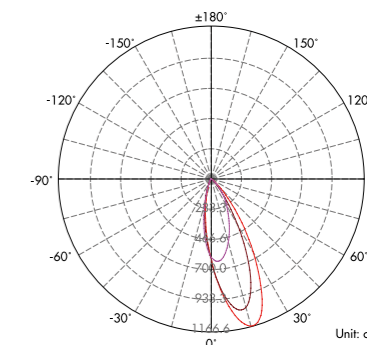
Used as step lights, inground lights !

Asymmetrical 15° x X° design !

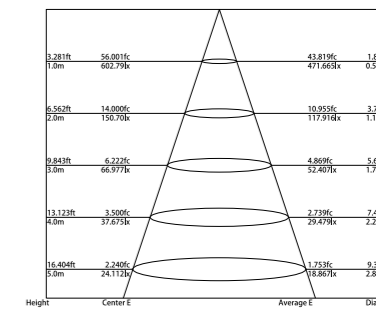
Dimension



Light Distribution Curve (3000K,7W,15x28°)



Lux distance Curve (3000K,7W,15x28°)



Illumination Picture (15x28°)



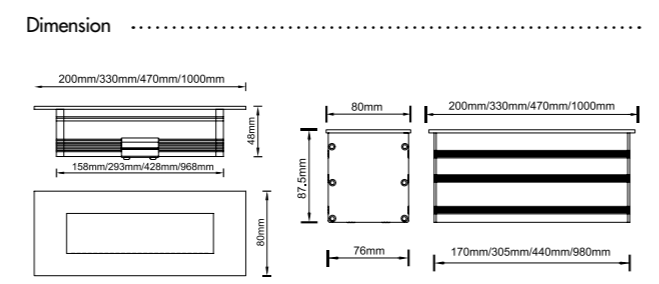
General Data	
Item No.	UL-C012-0700B / UL-C012-1400B / UL-C012-2100B / UL-C012-4900B
Power	7W / 14W / 21W / 49W +10%
LED type	3PCS / 6PCS / 9PCS / 21PCS CREE XPE LED
Luminous flux	400/800/1200/2800 lm +10%
CCT	2700K, 3000K, 4000K, 6000K
CRI	80+
Beam angle	Asymmetrical 15°x(6°/8°/10°/15°/17°/23°/28°/43°/58°/95°options)
Dimension	200/330/470/1000x 80 x 87.5 (mm) Length x Width x Height
Cut out	175mm/310mm/445mm/985mm x 80 x 85 (mm) Length x Width x Height
Net weight	/ kgs
Warranty	1 year
Certifications	CE, RoHS
Electrical Data	
Input voltage	DC 12V-DC24V
Insulation class	Class III
Cable	1PC rubber cable 1M H05RN-F 2x1mm square
Driver	Low voltage constant current driver without transformer
Construction Data	
IP rating	IP67 Waterproof
IK rating	IK08
Housing	Passivated(Anodizing) Aluminum
Protection finishing	20~25µm thickness anodized film for housing. Dark grey
Trim	Stainless steel 316
Glass	Step tempered Glass. T=8mm.
Loading capacity	500 kgs
Cable Gland	PG gland
Gasket	PMQ silicone seal
Accessories	
Mounting Sleeve	Passivated (Anodizing) Aluminum. Dark grey
Packaging	
Inner box size	/ mm
Carton size	/ cm (/ PCS / carton)



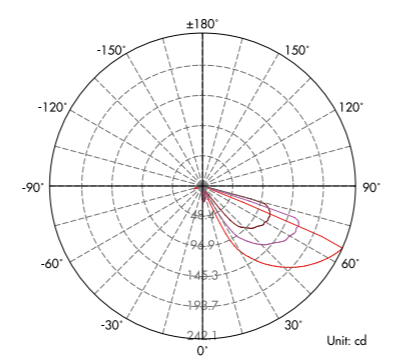
CE RoHS COMPLIANT IP67 IK08

SSS 316 1 Year Warranty

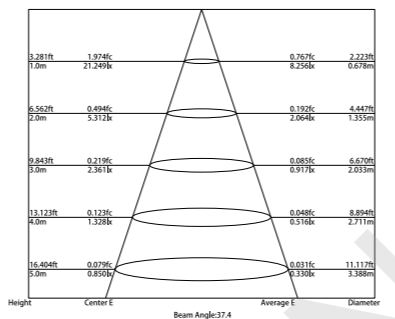
Used as step lights, inground lights!
Asymmetrical 50°x 40°+ Anti-glare Black reflector design!



Light Distribution Curve (3000K, 7W, 50°x40°)



Lux distance Curve (3000K, 7W, 50°x40°)



Illumination Picture (7W, 50°x40°)



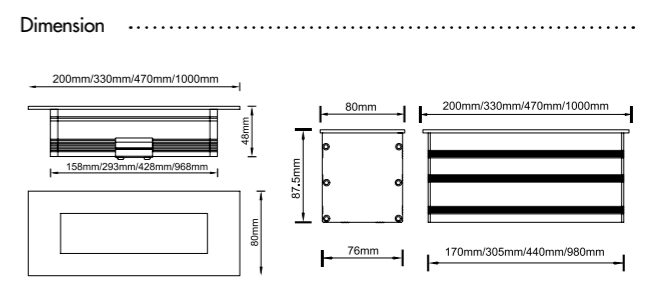
Parameter	
General Data	
Item No.	ULC012-0700C / ULC012-1400C / ULC012-2100C / ULC012-4900C
Power	7W / 14W / 21W / 49W +10%
LED type	OSRAM 2835SMD LED
Luminous flux	200lm / 390lm / 580lm / 1400lm+10%
CCT	2700K, 3000K, 4000K, 6000K
CRI	80+
Beam angle	Asymmetrical 50°x40°
Dimension	200/330/470/1000x 80 x 87.5 (mm) Length x Width x Height
Cut out	175mm/310mm/445mm/985mm x 80 x 85 (mm) Length x Width x Height
Net weight	/ kgs
Warranty	1 year
Certifications	CE, RoHS
Electrical Data	
Input voltage	DC24V
Insulation class	Class III
Cable	1PC rubber cable 1M H05RN-F 2x1mm square
Driver	Low voltage constant current driver without transformer
Construction Data	
IP rating	IP67 Waterproof
IK rating	IK08
Housing	Passivated(Anodizing) Aluminum
Protection finishing	20~25µm thickness anodized film for housing. Dark grey
Trim	Stainless steel 316
Glass	Step tempered Glass. T=8mm.
Loading capacity	500 kgs
Cable Gland	PG gland
Gasket	PMQ silicone seal
Accessories	
Mounting Sleeve	Passivated (Anodizing) Aluminum. Dark grey
Packaging	
Inner box size	/ mm
Carton size	/ cm (/ PCS / carton)



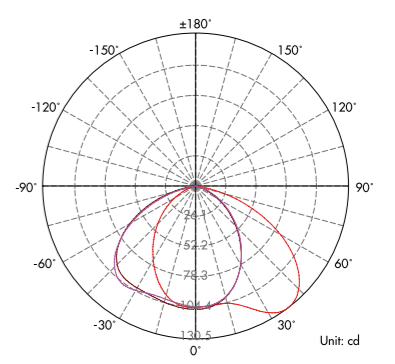
CE RoHS COMPLIANT IP67 IK08

SSS 316 1 Year Warranty

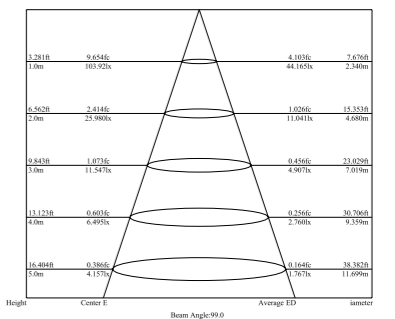
Used as step lights, inground lights!
Asymmetrical white reflector +Frosted glass!



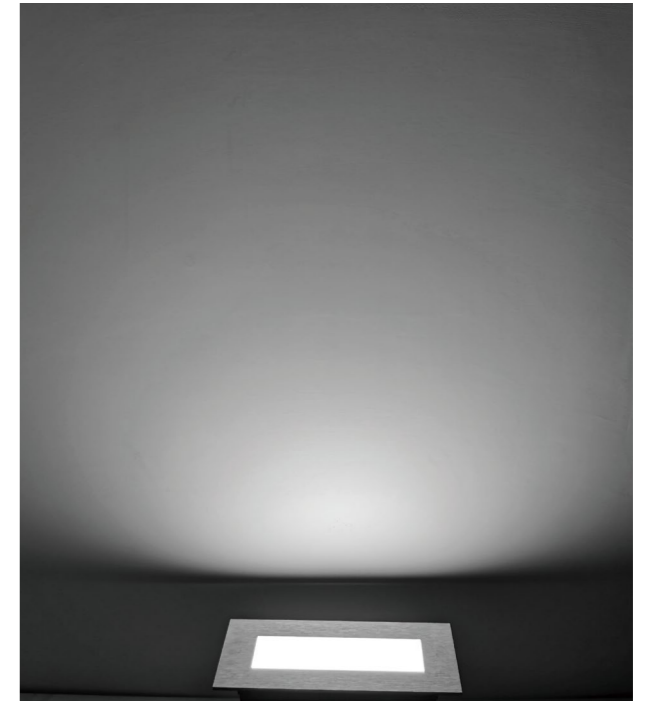
Light Distribution Curve (3000K, 7W, 120°)



Lux distance Curve (3000K, 7W, 120°)



Illumination Picture (7W, 120°)



Parameter	
General Data	
Item No.	ULC012-0700C(F) / ULC012-1400C(F) / ULC012-2100C(F) / ULC012-4900C(F)
Power	7W / 14W / 21W / 49W +10%
LED type	OSRAM 2835SMD LED
Luminous flux	200lm / 390lm / 580lm / 1400lm+10%
CCT	2700K, 3000K, 4000K, 6000K
CRI	80+
Beam angle	120°
Dimension	200/330/470/1000x 80 x 87.5 (mm) Length x Width x Height
Cut out	175mm/310mm/445mm/985mm x 80 x 85 (mm) Length x Width x Height
Net weight	/ kgs
Warranty	1 year
Certifications	CE, RoHS
Electrical Data	
Input voltage	DC24V
Insulation class	Class III
Cable	1PC rubber cable 1M H05RN-F 2x1mm square
Driver	Low voltage constant current driver without transformer
Construction Data	
IP rating	IP67 Waterproof
IK rating	IK08
Housing	Passivated(Anodizing) Aluminum
Protection finishing	20~25µm thickness anodized film for housing. Dark grey
Trim	Stainless steel 316
Glass	Step tempered frosted glass. T=8mm
Loading capacity	500 kgs
Cable Gland	PG gland
Gasket	PMQ silicone seal
Accessories	
Mounting Sleeve	Passivated (Anodizing) Aluminum. Dark grey
Packaging	
Inner box size	/ mm
Carton size	/ cm (/ PCS / carton)

INGROUND LIGHTS SERIES

INGROUND LIGHTS SERIES



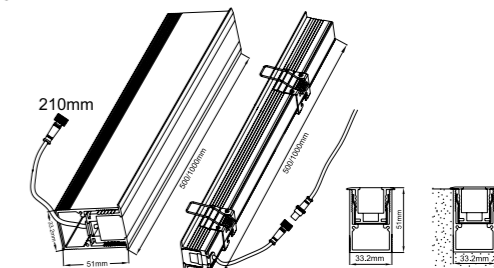
CE RoHS COMPLIANT IP67 IK08

SSS 316 Passivated 1 Year Warranty

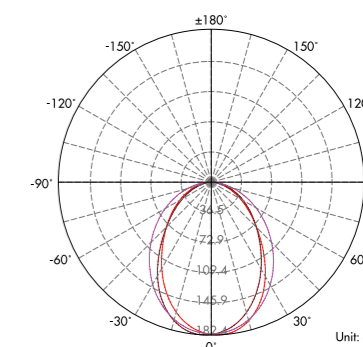
Inground lights and ceiling lights!
No dark areas!

Parameter	
General Data	
Item No.	UL-C008-2500A/UL-C008-1200-A
Power	24 Watts (12 watts as options)
LED type	198 PCS 2835 SMD LED
Luminous flux	1200~1350 lm (500~560lm for 12 watts)
CCT	2700K, 3000K, 4000K, 6000K, R/G/Y/B
CRI	80+
Beam angle	120°
Dimension	1000 x 33.2 x 51 (mm) Length x Width x Height (0.5 meters version as options)
Cut out	1000 x 33.2 x 51 (mm) Length x Width x Height
Net weight	1.720 kgs
Warranty	1 year
Certifications	CE, RoHS
Electrical Data	
Input voltage	DC24V (With a separately driver as options)
Insulation class	Class III
Cable	2 x cable 1.5cm H05RN-F 2x0.75mm square with IP67 waterproof connector male +female.
Driver	Low voltage constant current output, excluding the transformer
Construction Data	
IP rating	IP67 Waterproof
IK rating	IK08
Housing	Passivated(Anodizing) Aluminum
Protection finishing	20~25µm thickness anodized film for housing. Dark grey
Trim	Passivated(Anodizing) Aluminum
Glass	Without glass, but with strong PMMA diffuser
Loading capacity	200 kgs
Cable Gland	Glue
Gasket	/
Accessories	
Mounting Sleeve	Passivated (Anodizing) Aluminum CNC machined. Dark grey. With 2 PCS clips for mounting sleeve,
Others	2 PCS springs for ceiling lights applications, and 2 PC end caps with screws
Packaging	
Inner box size	1020*40*60 mm
Carton size	104*34*20 cm (24PCS / carton)

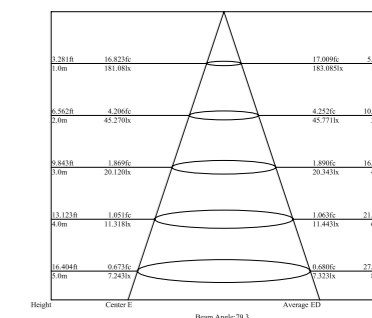
Dimension



Light Distribution Curve (3000K, 120°)



Lux distance Curve (3000K, 120°)



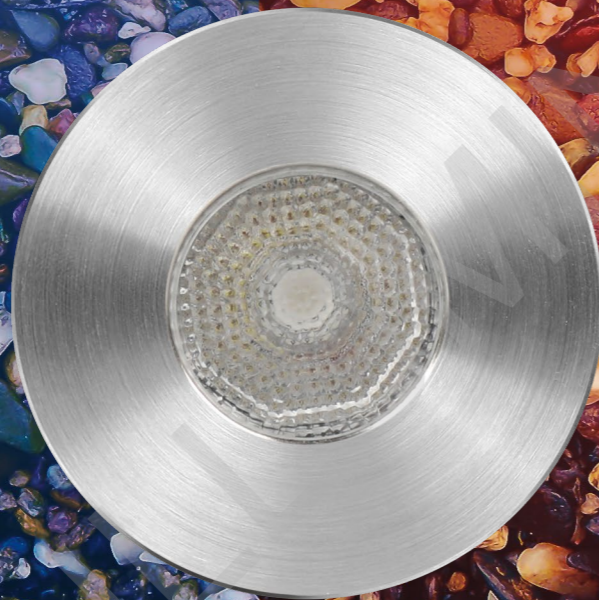
Illumination Picture (120°)

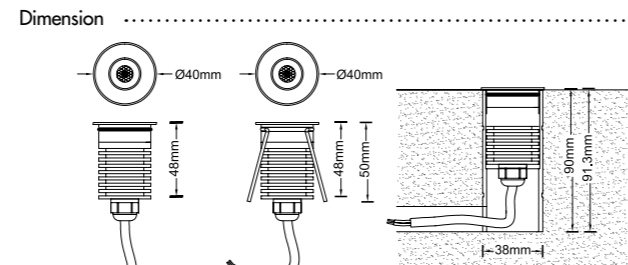


INGROUND LIGHTS SERIES

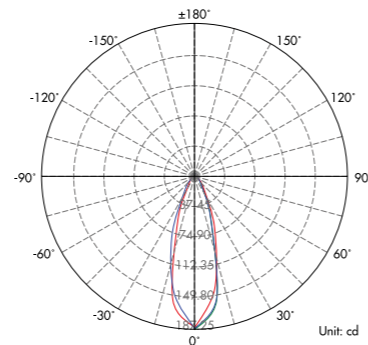
INGROUND LIGHTS SERIES

1.11 RGB/RGBW GROUND SPOT SERIES

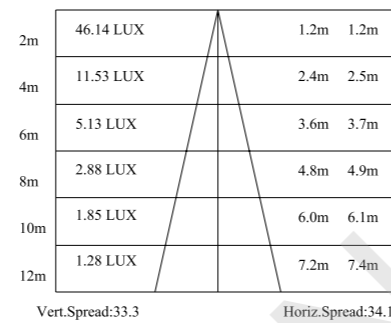




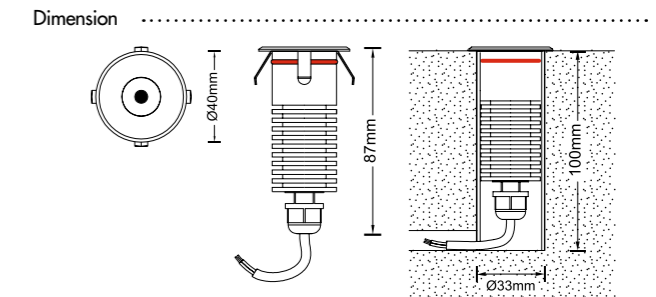
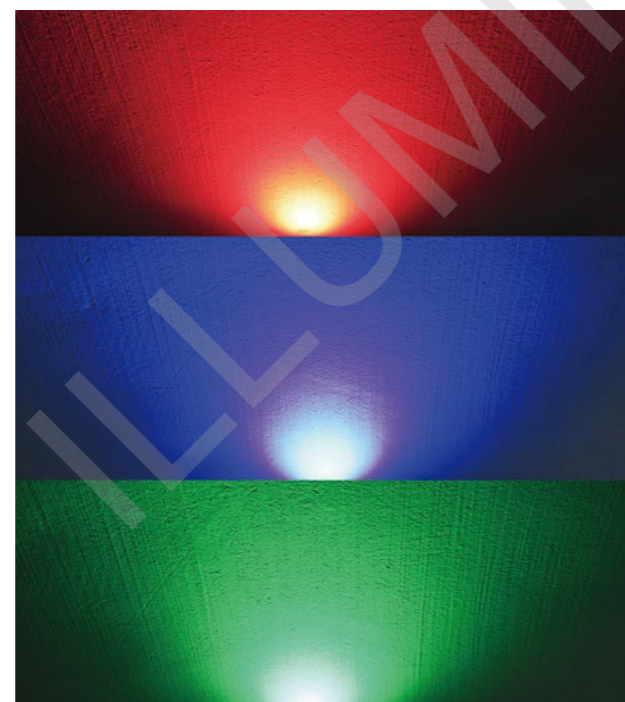
Light Distribution Curve (RGBW5500K, 1x30°)



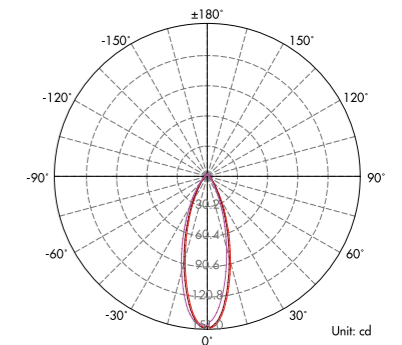
Lux distance Curve (RGBW5500K, 1x30°)



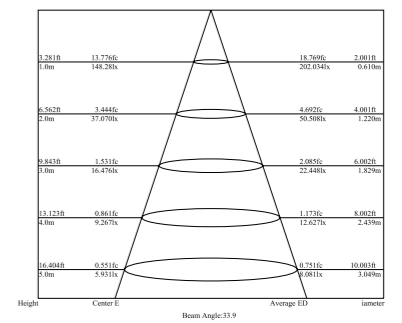
Illumination Picture (1x30°)



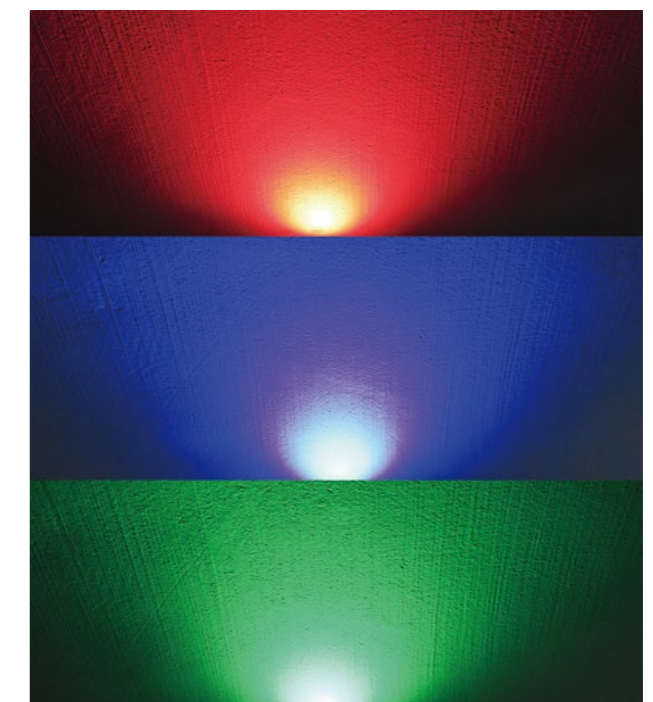
Light Distribution Curve (RGB, 45°)



Lux distance Curve (RGB, 45°)



Illumination Picture (45°)



CE RoHS COMPLIANT IP67 IK06

SSS 316 Passivated 1 Year Warranty

Parameter	
General Data	
Item No.	UL-1001-0300(RGBW)-A
Power	4 Watts
LED type	1 PC 4W 4in1 RGBW5500K LED as standard (RGB optional)
Luminous flux	/
CCT	RGBW5500K
CRI	/
Beam angle	30°
Dimension	Ø40x50 (mm) Diameter x length
Cut out	38 mm
Net weight	0.25 kgs
Warranty	1 year
Certifications	CE, RoHS
Electrical Data	
Input voltage	DC12V
Insulation class	Class III
Cable	1PC rubber cable 1.5M H05RN-F 5x0.5mm ² square
Driver	Low voltage constant current output, excluding the transformer
Construction Data	
IP rating	IP67 Waterproof
IK rating	IK06
Housing	Solid Passivated (Anodizing) Aluminum CNC machined
Protection finishing	20~25µm thickness anodized film for housing. Dark grey
Trim	Stainless steel 316
Glass	Step tempered Glass. T=4mm.
Loading capacity	320 kgs
Cable Gland	PG9 IP67
Gasket	O-ring PMQ silicone seal
Accessories	
Mounting Sleeve	Passivated (Anodizing) Aluminum CNC machined. Dark grey
Clip	With Aluminium spring that's for deck lights or ceiling lights application
Packaging	
Inner box size	110*85*60 mm
Carton size	44*24*32 cm (50PCS / carton)

CE RoHS COMPLIANT IP67 IK09

SSS 316 Passivated 1 Year Warranty

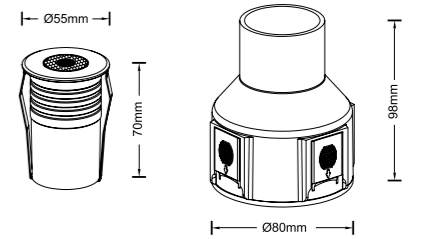
Parameter	
General Data	
Item No.	UL-1003-0300(RGB)-A
Power	3 Watts
LED type	1 PC 3W 3in1 RGB LED
Luminous flux	95 lm (All LED chips on)
CCT	RGB
CRI	70+
Beam angle	20°, 45°, 60°
Dimension	40 x 87 (mm) Diameter x Height
Cut out	33mm
Net weight	0.27 kgs
Warranty	1 year
Certifications	CE, RoHS
Electrical Data	
Input voltage	DC12V
Insulation class	Class III
Cable	1 x cable 1.5M H05RN-F 4x0.75mm square to open wires
Driver	Low voltage constant current output, excluding the transformer
Construction Data	
IP rating	IP67 Waterproof
IK rating	IK09
Housing	Solid Passivated (Anodizing) Aluminum CNC machined
Protection finishing	20~25µm thickness anodized film for housing. Dark grey
Trim	Stainless Steel 316
Glass	Step style, Super White, Tempered Glass. T=10mm.
Loading capacity	500 kgs
Cable Gland	Nickel Copper PG9 IP67
Gasket	O-ring PMQ silicone seal
Accessories	
Mounting Sleeve	Solid Passivated (Anodizing) Aluminum CNC machined. Dark grey
Clip	With Aluminium spring that's for deck lights or ceiling lights application
Packaging	
Inner box size	120*85*60 mm
Carton size	49*24*33 cm (50 PCS / carton)



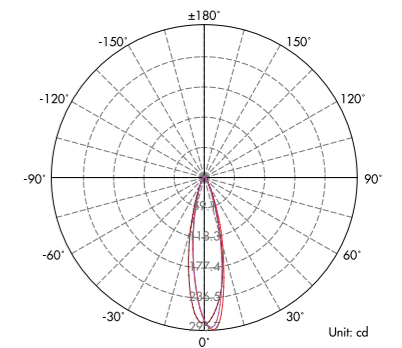
CE RoHS COMPLIANT IP67 IK06

SSS 316 Passivated 1 Year Warranty

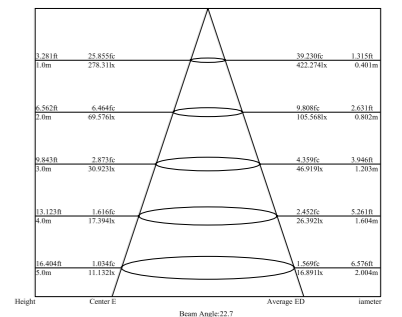
Dimension



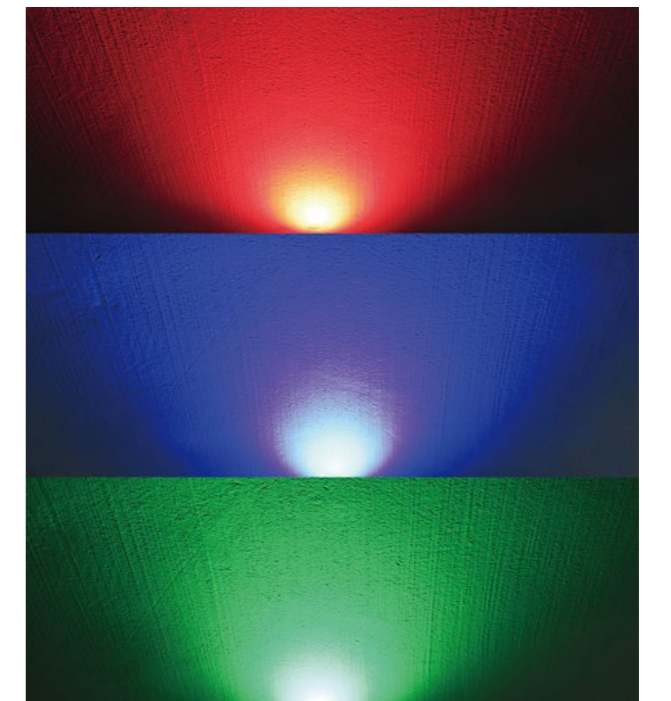
Light Distribution Curve (RGB, 25°)



Lux distance Curve (RGB, 25°)



Illumination Picture (25°)



Parameter	
General Data	
Item No.	UL-1009-0300(RGB)-B
Power	3 Watts
LED type	1 PC 3W 3in1 LED
Luminous flux	105 lm (All LEDs on)
CCT	RGB
CRI	70+
Beam angle	25°, 45°
Dimension	55 x 70 (mm) Diameter x Height
Cut out	80 mm
Net weight	0.42 kgs
Warranty	1 year
Certifications	CE, RoHS
Electrical Data	
Input voltage	DC 12V
Insulation class	Class III
Cable	1PC rubber cable 1.5M H05RN-F 4x0.75mm square
Driver	Low voltage constant current output, excluding the transformer
Construction Data	
IP rating	IP67 Waterproof
IK rating	IK06
Housing	Solid Passivated (Anodizing) Aluminum CNC machined
Protection finishing	20~25µm thickness anodized film for housing. Dark grey
Trim	Stainless steel 316
Glass	Step tempered Glass. T=6mm.
Loading capacity	320 kgs
Cable Gland	PG9 IP67
Gasket	O-ring PMQ silicone seal
Accessories	
Mounting sleeve	Anti-corrosion Black PVC
Packaging	
Inner box size	88*88*105 mm
Carton size	46*28.5*24 cm (30PCS / carton)

INGROUND LIGHTS SERIES

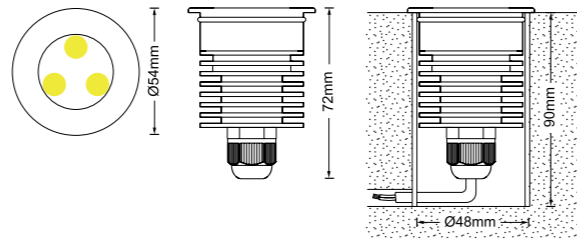


CE RoHS COMPLIANT IP67 IK06

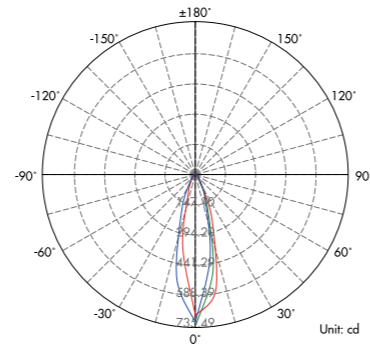
SSS 316 Passivated 1 Year Warranty

Parameter	
General Data	
Item No.	UL-3005-0300(RGB)-A
Power	3 Watts
LED type	3pcs 1W 3in 1
Luminous flux	130 lm (All LED on)
CCT	RGB
CRI	70+
Beam angle	25°, 45°
Dimension	54 x 72 (mm) Diameter x Height
Cut out	48 mm
Net weight	0.390 kgs
Warranty	1 year
Certifications	CE, RoHS
Electrical Data	
Input voltage	DC 12V
Insulation class	Class III
Cable	1PC rubber cable 1.5M H05RN-F 4x0.75mm square
Driver	Low voltage constant current output, excluding the transformer
Construction Data	
IP rating	IP67 Waterproof
IK rating	IK06
Housing	Solid Passivated (Anodizing) Aluminum CNC machined
Protection finishing	20~25µm thickness anodized film for housing. Dark grey
Trim	Stainless steel 316
Glass	Step tempered Glass. T=8mm.
Loading capacity	320 kgs
Cable Gland	PG9 IP67
Gasket	O-ring PMQ silicone seal
Accessories	
Mounting sleeve	Passivated (Anodizing) Aluminum CNC machined. Dark grey
Packaging	
Inner box size	90*59*100 mm
Carton size	46.8*31.3*21.8 cm (50 PCS / carton)

Dimension



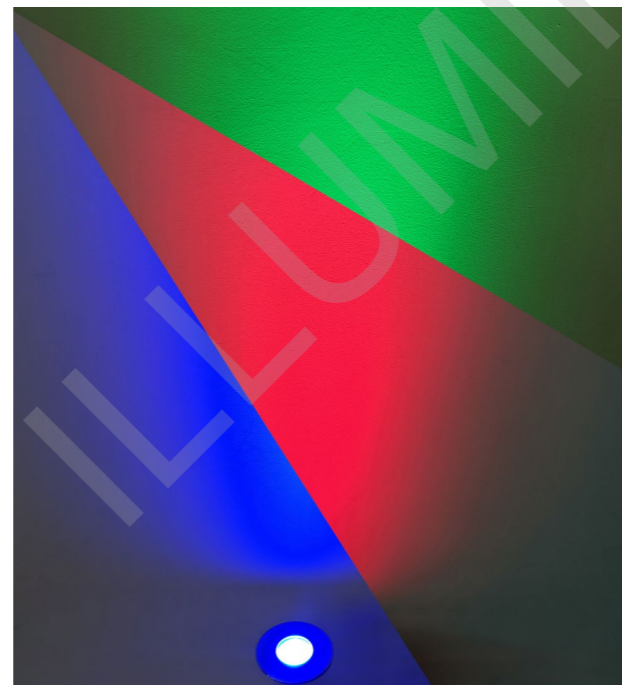
Light Distribution Curve (RGB, 25°)



Lux distance Curve (RGB, 25°)

Distance (m)	Illuminance at a Distance	
	Center Beam LUX	Beam Width V H
2m	170.99 LUX	0.9m 1.0m
4m	42.75 LUX	1.9m 1.9m
6m	19.00 LUX	2.8m 2.9m
8m	10.69 LUX	3.8m 3.8m
10m	6.84 LUX	4.7m 4.8m
12m	4.75 LUX	5.6m 5.8m

Illumination Picture (25°)



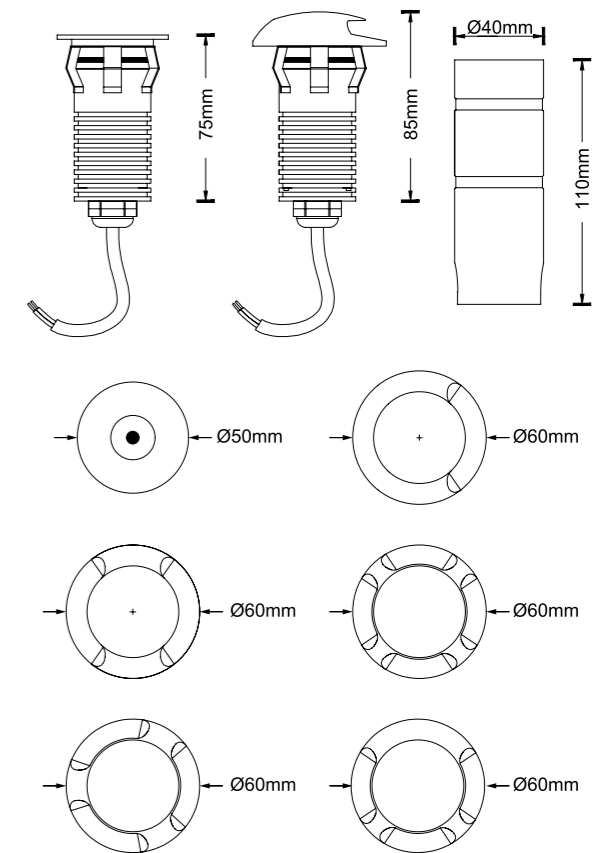
CE RoHS COMPLIANT IP67 IK09

SSS 316 1 Year Warranty

One IP67 body is compatible with seven covers !
RGBW as standard, one color version optional.

Parameter	
General Data	
Item No.	UL-1022-0300(RGBW)-A
Power	3 Watts
LED type	1 PC 3030 RGBW 4in1 LED /[1 PC 3W CREE XPE LED for single color version as options]
Luminous flux	/
CCT	RGBW (3000K or 4000K or 5500K) /[single color 2700K, 3000K, 4000K, 6000K as options]
CRI	/
Beam angle	5°, 10°, 17°, 23°, 28°, 43°, 58°
Dimension	50x75 / 60 x 85 (mm) (Diameter x length)
Cut out	/
Net weight	/ kgs
Warranty	1 year
Certifications	CE, RoHS
Electrical Data	
Input voltage	DC 12V for RGBW (DC 12-24V for one color version optional)
Insulation class	Class III
Cable	1PC rubber cable 1M H05RN-F 5x0.5mm square
Driver	Low voltage input, constant current output, excluding the transformer
Construction Data	
IP rating	IP67 Waterproof
IK rating	IK09
Housing	Solid Passivated (Anodizing) Aluminum CNC machined
Protection finishing	20~25µm thickness anodized film for housing
Trim	Stainless steel 316
Glass	Tempered Glass. T=8 mm
Loading capacity	500 kgs
Cable Gland	PG gland
Gasket	O-ring PMQ silicone seal
Accessories	
Mounting Sleeve	Aluminum sleeve in dark grey
Clip	With Aluminium spring that's for deck lights or ceiling lights application as options
Packaging	
Inner box size	65*17*65 mm
Carton size	35*35*6 cm (50 PCS / carton)

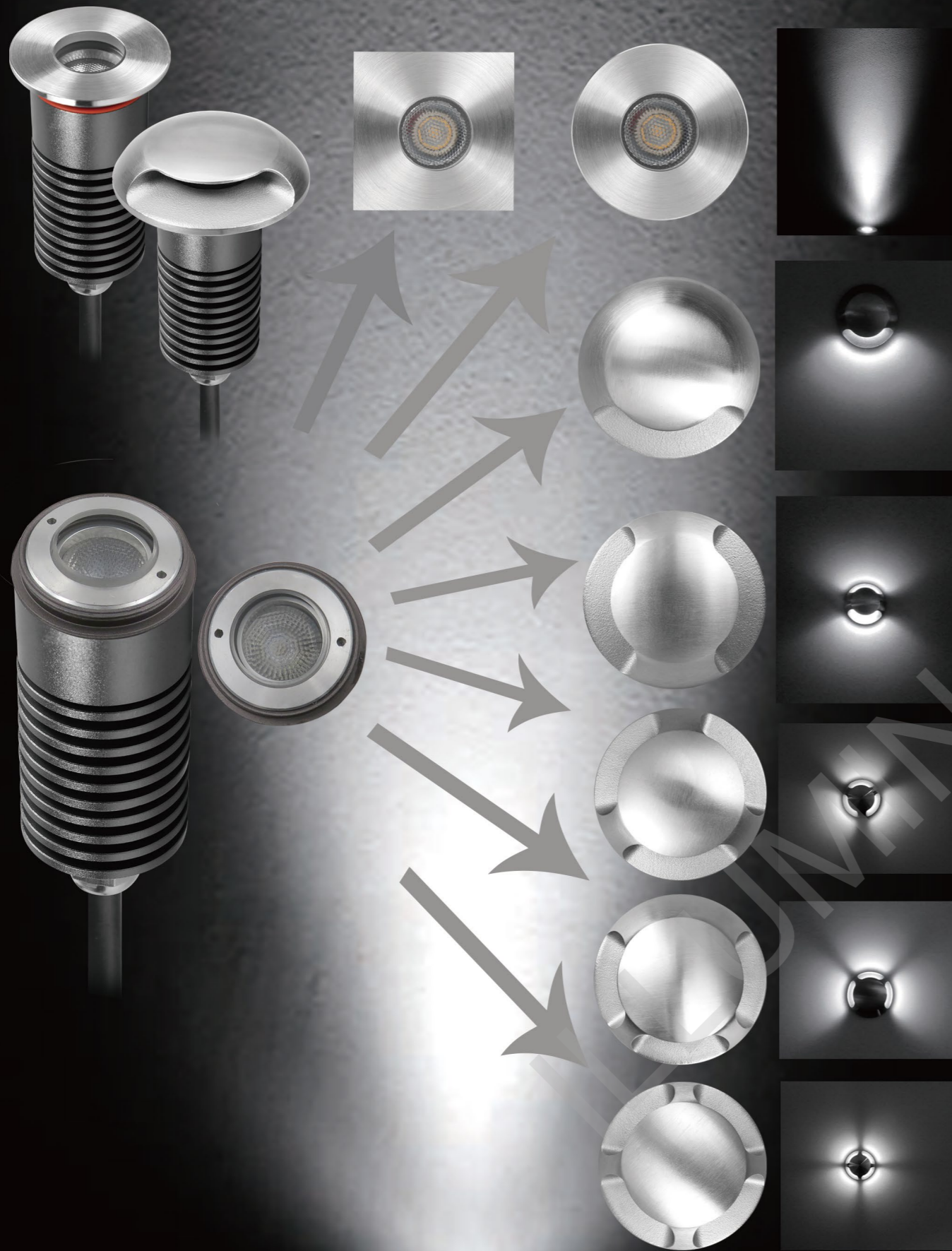
Dimension



Illumination Picture (Two way)



One IP67 body is compatible with seven covers !



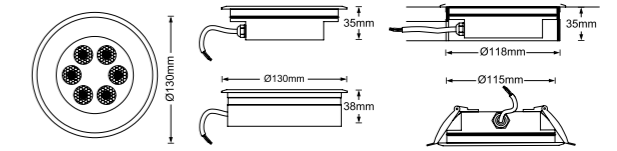
CE RoHS COMPLIANT IP67 IK08

SSS 316 1 Year Warranty

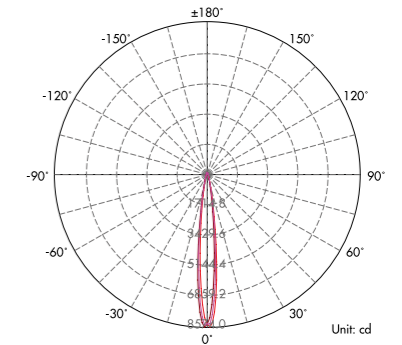
Used as inground lights, downlights, deck lights !

Parameter	
General Data	
Item No.	UL-6001-0900(RGBWH)
Power	9 Watts +10%
LED type	6 PCS 4in1 RGBVV LED (RGB LED optional)
Luminous flux	/
CCT	RGBW(5500K or 4000K or 3000K) or RGB
CRI	/
Beam angle	Symmetric: 5°, 10°, 17°, 23°, 28°, 43°, 58° Asymmetric: 15°x25°, 15°x30°, 15°x45°, 15°x60° (tilt + pan)
Dimension	Ø130x35 (mm) Diameter x length
Cut out	Inground light: Ø118 mm Deck light: Ø115 mm
Net weight	0.77 kgs
Warranty	1 year
Certifications	CE, RoHS
Electrical Data	
Input voltage	DC24V
Insulation class	Class III
Cable	TPC rubber cable 1M H05RN-F 5x0.5mm square
Driver	Low voltage input, constant current output, excluding the transformer
Construction Data	
IP rating	IP67 Waterproof
IK rating	IK08
Housing	Solid Passivated (Anodizing) Aluminum CNC machined
Protection finishing	20~25µm thickness anodized film for housing. Dark grey color
Trim	Stainless steel 316
Glass	Step tempered Glass. T=8mm.
Loading capacity	500 kgs
Cable Gland	PG gland
Gasket	O-ring PMQ silicone seal
Accessories	
Mounting Sleeve	Aluminium sleeve used as inground light
Clip	Two clips with screws optional used as downlight / deck light
Packaging	
Inner box size	140*140*60 mm
Carton size	30.5*30.5*20.5CM (12PCS/CTN)

Dimension



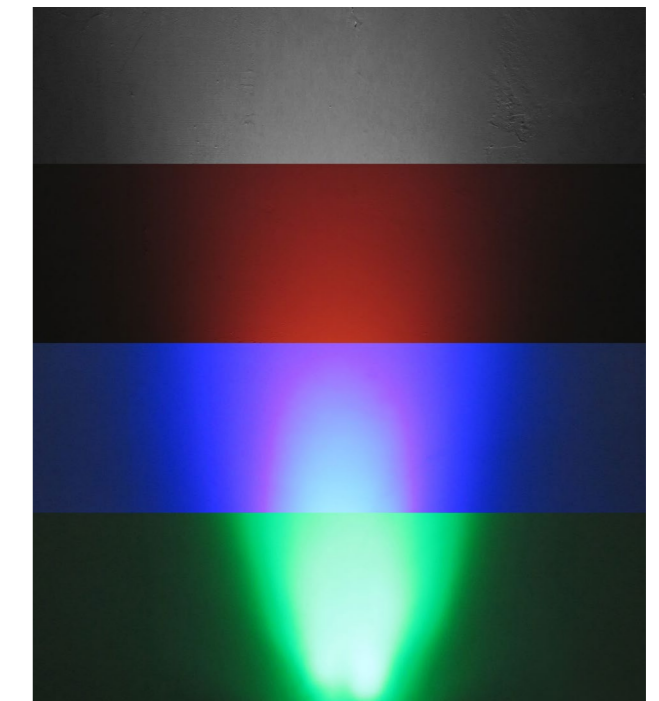
Light Distribution Curve (15°)



Lux distance Curve (15°)

Height	Center E	Beam Angle: 1 2.0	Average E	Diameter
3.281ft	779.02fc		564.662fc	0.687ft
1.0m	8385.4lx		6078.021lx	0.209m
6.562ft	194.75fc		141.165fc	1.374ft
2.0m	2096.3lx		1519.505lx	0.419m
9.843ft	86.558fc		62.740fc	2.061ft
3.0m	931.71lx		675.336lx	0.628m
13.123ft	48.689fc		35.291fc	2.748ft
4.0m	524.09lx		379.876lx	0.837m
16.404ft	31.161fc		22.586fc	3.434ft
5.0m	335.41lx		243.121lx	1.047m

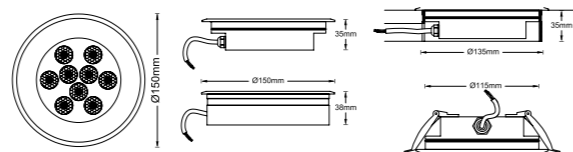
Illumination Picture (15°)



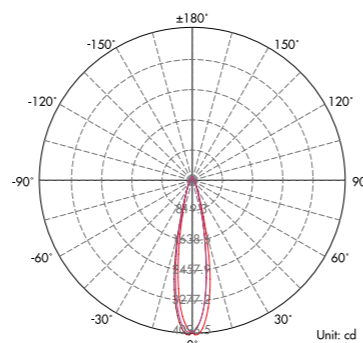
INGROUND LIGHTS SERIES



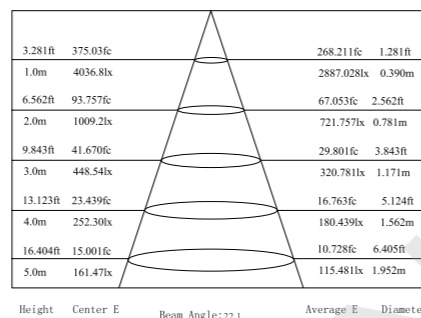
Dimension



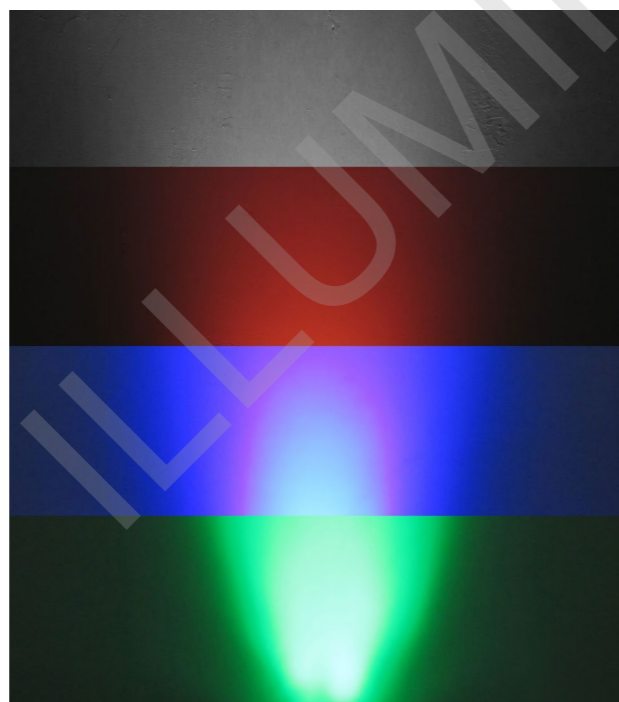
Light Distribution Curve (15°)



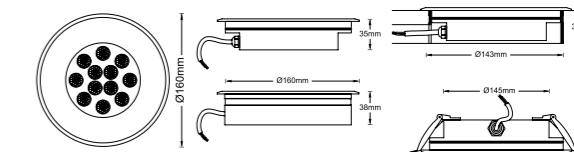
Lux distance Curve (15°)



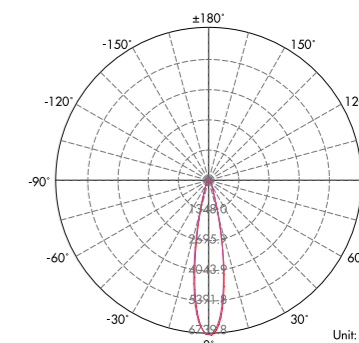
Illumination Picture (15°)



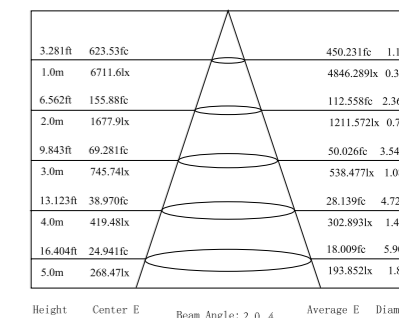
Dimension



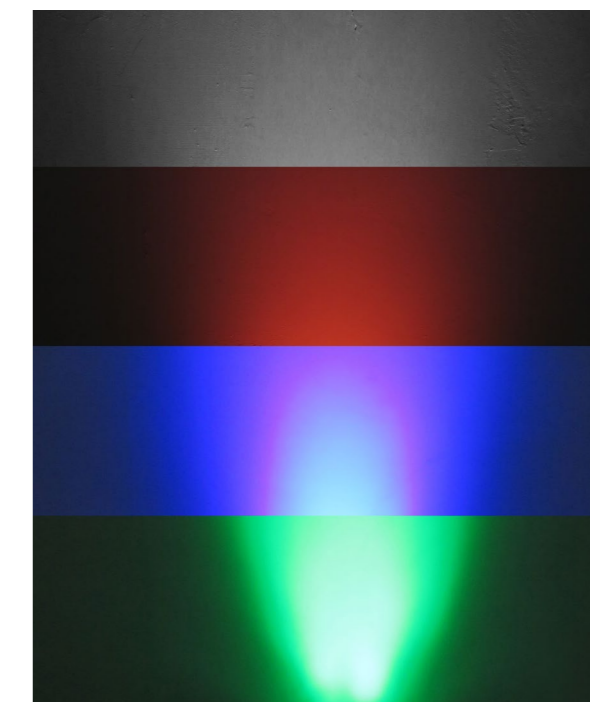
Light Distribution Curve (17°)



Lux distance Curve (17°)



Illumination Picture (17°)



CE RoHS COMPLIANT IP67 IK08

SSS 316 1 Year Warranty

Used as inground lights, downlights, deck lights !

Parameter	
General Data	
Item No.	UL-9001-1200(RGBW)
Power	12 Watts +10%
LED type	9 PCS 4in1 RGBW LED (RGB LED optional)
Luminous flux	/
CCT	RGBW (5500K or 4000K or 3000K) or RGB
CRI	/
Beam angle	Symmetric: 5°, 10°, 17°, 23°, 28°, 43°, 58° Asymmetric: 15°x25°, 15°x30°, 15°x45°, 15°x60° (tilt + pan)
Dimension	Ø150x35 (mm) Diameter x length
Cut out	Inground light: Ø118 mm Deck light: Ø115 mm
Net weight	1.05 kgs
Warranty	1 year
Certifications	CE, RoHS
Electrical Data	
Input voltage	DC24V
Insulation class	Class III
Cable	1PC rubber cable 1M H05RN-F 5x0.5mm square
Driver	Low voltage input, constant current output, excluding the transformer
Construction Data	
IP rating	IP67 Waterproof
IK rating	IK08
Housing	Solid Passivated (Anodizing) Aluminum CNC machined
Protection finishing	20~25µm thickness anodized film for housing. Dark grey color
Trim	Stainless steel 316
Glass	Step tempered Glass. T=8mm.
Loading capacity	500 kgs
Cable Gland	PG gland
Gasket	O-ring PMQ silicone seal
Accessories	
Mounting Sleeve	Aluminium sleeve used as inground light
Clip	Two clips with screws optional used as downlight / deck light
Packaging	
Inner box size	160*160*60 mm
Carton size	34.5*34.5*20.5CM (12PCS/CTN)

CE RoHS COMPLIANT IP67 IK08

SSS 316 1 Year Warranty

Used as inground lights, downlights, deck lights !

Parameter	
General Data	
Item No.	UL-1201-1500(RGBW)
Power	15 Watts +10%
LED type	12 PCS 4in1 RGBW LED (RGB LED optional)
Luminous flux	/
CCT	RGBW(5500K or 4000K or 3000K) or RGB
CRI	/
Beam angle	Symmetric: 5°, 10°, 17°, 23°, 28°, 43°, 58° Asymmetric: 15°x25°, 15°x30°, 15°x45°, 15°x60° (tilt + pan)
Dimension	Ø160x35 (mm) Diameter x length
Cut out	Inground light: Ø143 mm Deck light: Ø145 mm
Net weight	1.15 kgs
Warranty	1 year
Certifications	CE, RoHS
Electrical Data	
Input voltage	DC24V
Insulation class	Class III
Cable	1PC rubber cable 1M H05RN-F 5x0.5mm square
Driver	Low voltage input, constant current output, excluding the transformer
Construction Data	
IP rating	IP67 Waterproof
IK rating	IK08
Housing	Solid Passivated (Anodizing) Aluminum CNC machined
Protection finishing	20~25µm thickness anodized film for housing. Dark grey color
Trim	Stainless steel 316
Glass	Step tempered Glass. T=8mm.
Loading capacity	500 kgs
Cable Gland	PG gland
Gasket	O-ring PMQ silicone seal
Accessories	
Mounting Sleeve	Aluminium sleeve used as inground light
Clip	Two clips with screws optional used as downlight / deck light
Packaging	
Inner box size	170*170*60 mm
Carton size	36.5*36.5*14 cm (8 PCS / carton)



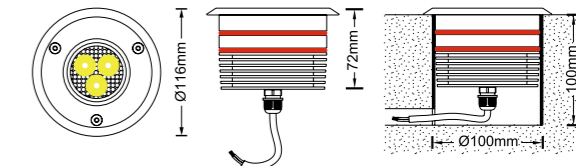
CE RoHS COMPLIANT IP67 IK09

SSS 316 Passivated 1 Year Warranty
Adjustable

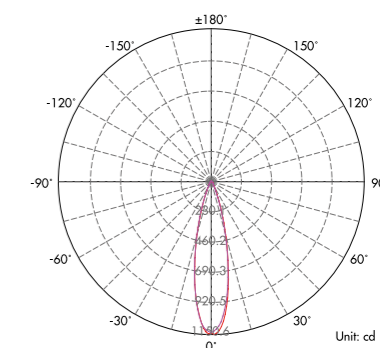
Parameter

General Data	
Item No.	UL-3002-0900(RGB)-A
Power	9 Watts
LED type	3 PCS 3W 3in 1 LED
Luminous flux	540 lm (ALL LEDs ON)
CCT	RGB
CRI	70+
Beam angle	25°, 45° (Direction adjustable with 20° at max)
Dimension	116 x 72 (mm) Diameter x Height
Cut out	100 mm
Net weight	1.31 kgs
Warranty	1 year
Certifications	CE, RoHS
Electrical Data	
Input voltage	DC12V
Insulation class	Class III
Cable	1PC rubber cable 1.5M H05RN-F 4x0.75mm square
Driver	Low voltage constant current output, excluding the transformer
Construction Data	
IP rating	IP67 Waterproof
IK rating	IK09
Housing	Solid Passivated (Anodizing) Aluminum CNC machined
Protection finishing	20~25µm thickness anodized film for housing. Dark grey
Trim	Stainless steel 316
Glass	Step tempered Glass. T=8mm.
Loading capacity	2000 kgs
Cable Gland	PG9 IP67
Gasket	O-ring PMQ silicone seal
Rotatable	Manual rotating bracket max 20°+20°
Accessories	
Mounting sleeve	Passivated (Anodizing) Aluminum CNC machined
Packaging	
Inner box size	121 * 121 * 112mm
Carton size	38 * 26 * 24 cm (12PCS / carton)

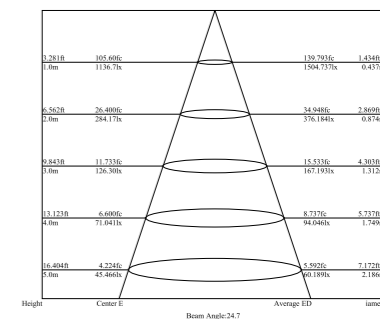
Dimension



Light Distribution Curve (RGB, 40°)



Lux distance Curve (RGB, 40°)



Illumination Picture (40°)



INGROUND LIGHTS SERIES



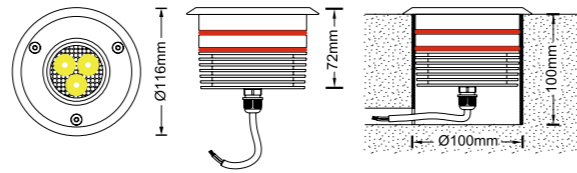
CE RoHS COMPLIANT IP67 IK09

SSS 316 Passivated 1 Year Warranty Adjustable

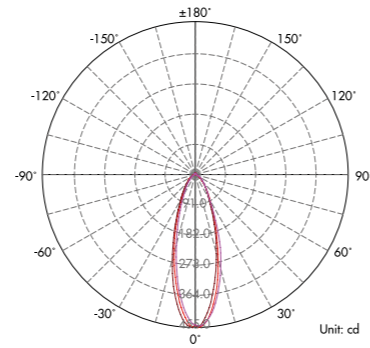
Parameter

General Data	
Item No.	UL-3002-1200(RGBW)-A
Power	12 Watts
LED type	3 PCS 4 watts 4in1 RGBW LED
Luminous flux	900 lm (ALL LEDS ON)
CCT	RGB+6000K CW or 3000K WW
CRI	70+
Beam angle	23°, 28°, 43°, 58° (Direction adjustable with 20° at max)
Dimension	116x72 (mm) Diameter x Height
Cut out	100 mm
Net weight	1.31 kgs
Warranty	1 year
Certifications	CE, RoHS
Electrical Data	
Input voltage	DC12V
Insulation class	Class III
Cable	1PC rubber cable 1.5M H05RNF 5x0.75mm square Low voltage
Driver	constant current output, excluding the transformer
Construction Data	
IP rating	IP67 Waterproof
IK rating	IK09
Housing	Solid Passivated (Anodizing) Aluminum CNC machined
Protection finishing	20~25µm thickness anodized film for housing. Dark grey
Trim	Stainless steel 316
Glass	Step tempered Glass. T=8mm.
Loading capacity	2000 kgs
Cable Gland	PG9 IP67
Gasket	O-ring PMQ silicone seal
Rotatable	Manual rotating bracket max 20°+20°
Accessories	
Mounting sleeve	Solid Passivated (Anodizing) Aluminum CNC machined
Packaging	
Inner box size	121*121*112mm
Carton size	38*26*24 cm (12PCS / carton)

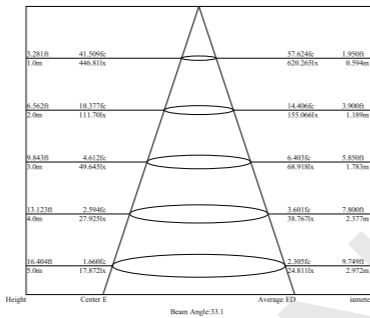
Dimension



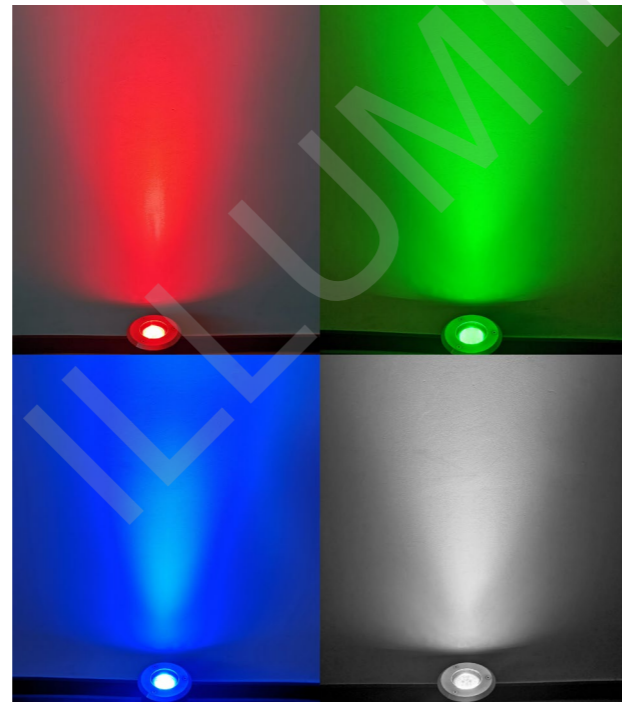
Light Distribution Curve (RGB+CW, 43°)



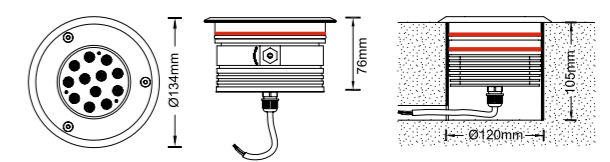
Lux distance Curve (RGB+CW, 43°)



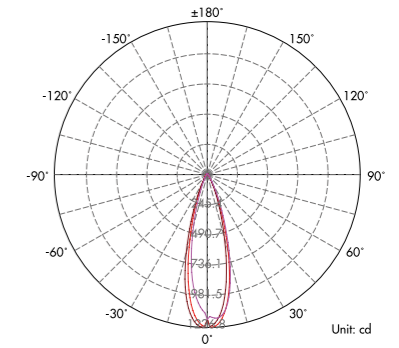
Illumination Picture (43°)



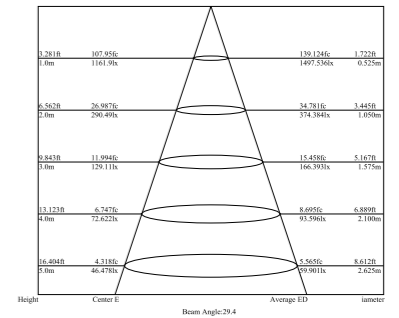
Dimension



Light Distribution Curve (RGB, 40°)



Lux distance Curve (RGB, 40°)



Illumination Picture (40°)



CE RoHS COMPLIANT IP67 IK09

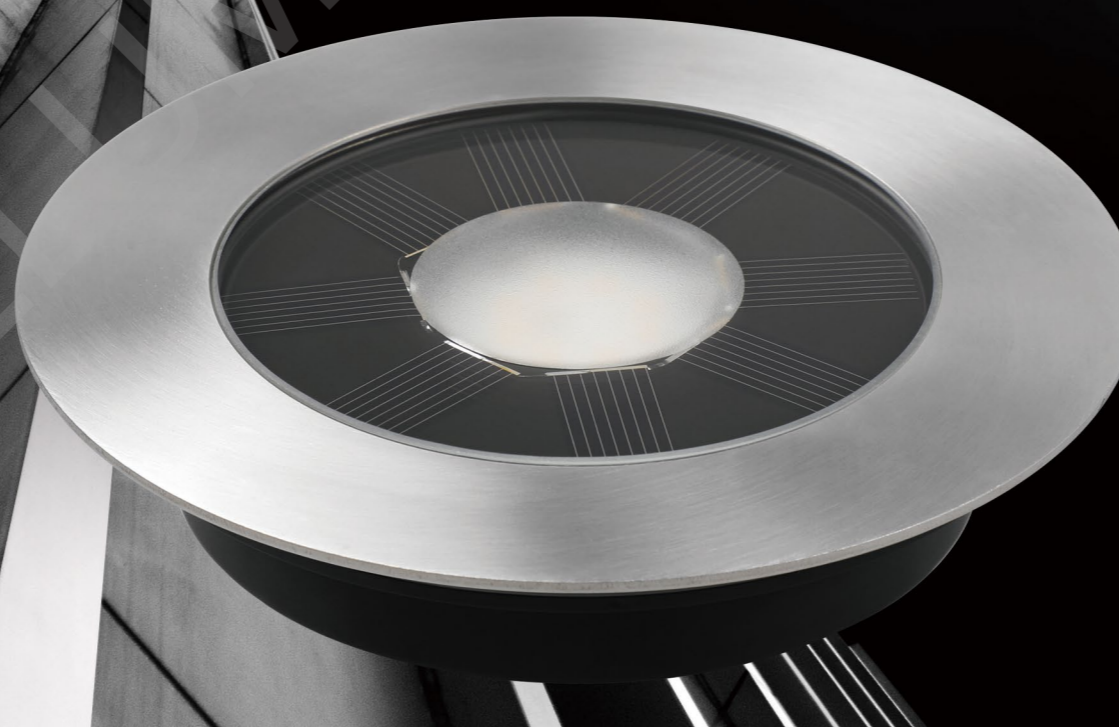
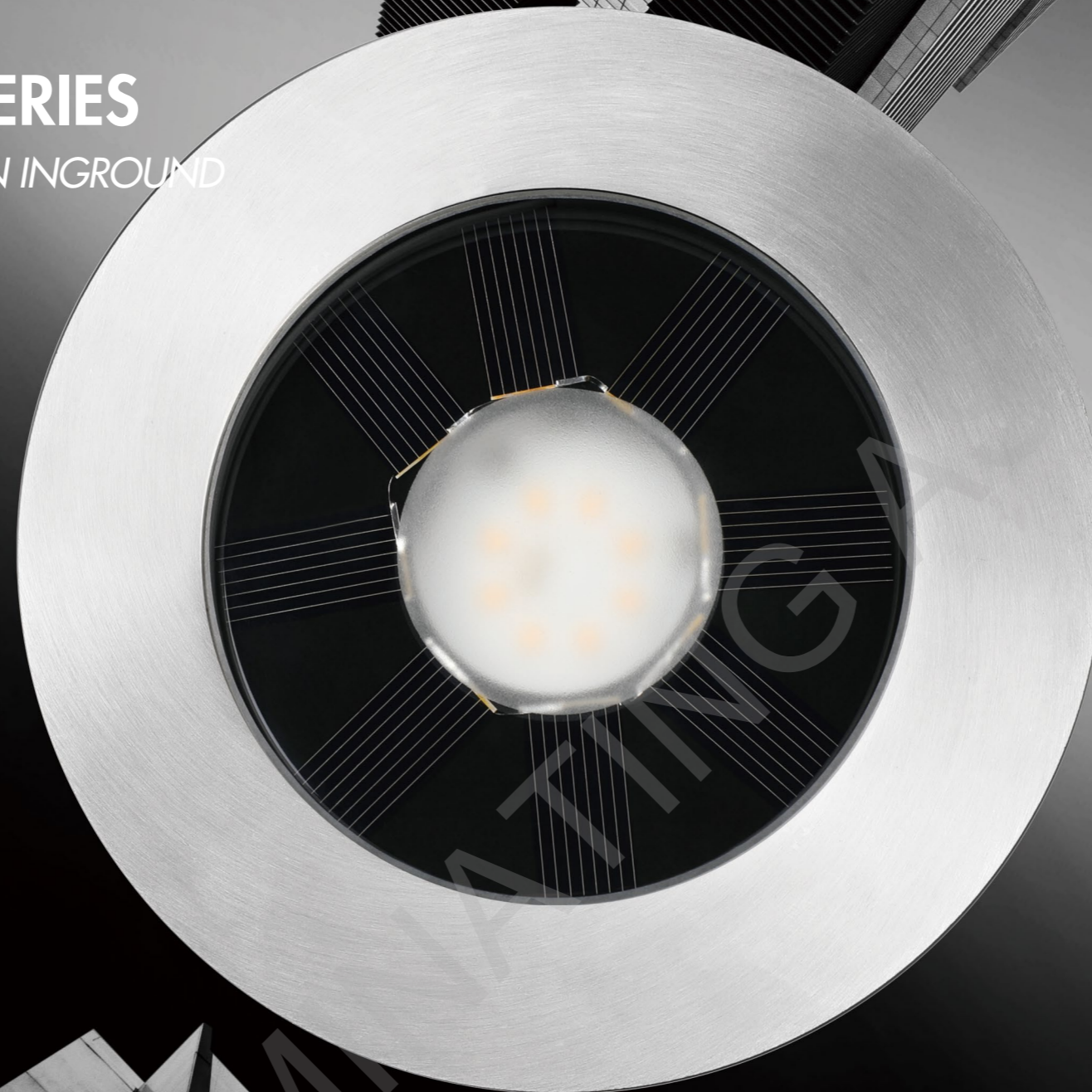
SSS 316 Passivated 1 Year Warranty Adjustable

Parameter

General Data	
Item No.	UL-1201-1200(RGB)-C
Power	12 Watts
LED type	4 PCS R, 4 PCS B, 4 PCS G CREE LED
Luminous flux	810 lm (ALL LEDS ON)
CCT	RGB
CRI	70+
Beam angle	15°, 25°, 30°, 45°, 60° (Direction adjustable with 30° at max)
Dimension	134x76 (mm) Diameter x Height
Cut out	120 mm
Net weight	1.85 kgs
Warranty	1 year
Certifications	CE, RoHS
Electrical Data	
Input voltage	DC24V
Insulation class	Class III
Cable	1PC rubber cable 1.5M H05RNF 4x0.75mm square
Driver	Low voltage constant current output, excluding the transformer
Construction Data	
IP rating	IP67 Waterproof
IK rating	IK09
Housing	Solid Passivated (Anodizing) Aluminum CNC machined
Protection finishing	20~25µm thickness anodized film for housing. Dark grey
Trim	Stainless steel 316
Glass	Step tempered Glass. T=10mm.
Loading capacity	2000 kgs
Cable Gland	PG9 IP67
Gasket	O-ring PMQ silicone seal
Rotatable	Manual rotating bracket max 20°+20°
Accessories	
Mounting sleeve	Passivated (Anodizing) Aluminum CNC machined
Packaging	
Inner box size	140*140*117 mm
Carton size	43.5*29.5*25 cm (12PCS / carton)

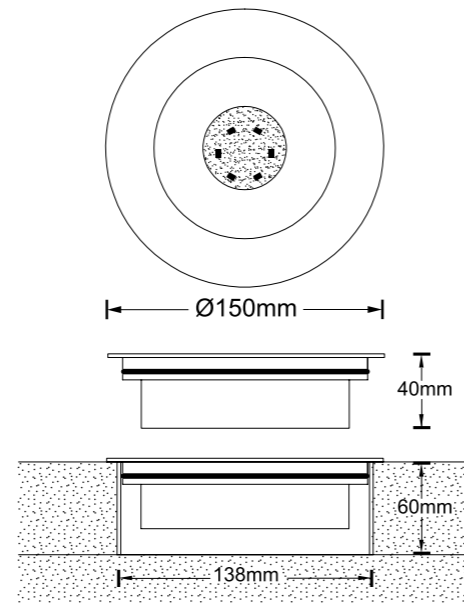
INGROUND LIGHTS SERIES

1.12 SOLAR POWERED DECORATION INGROUND LIGHT SERIES





Dimension



Illumination Picture (120°)



CE RoHS COMPLIANT IP67 IK07

Solar Power With Battery SSS 316

Passivated 1 Year Warranty

Parameter

General Data	
Item No.	UL-6001-0100-A (SOLAR)
Power	1 Watt
LED type	8 PCS 2835 SMD LED
Luminous flux	60~70 lm
CCT	2700K, 3000K, 4000K, 6000K
CRI	80+
Beam angle	120°
Dimension	Ø150x38 (mm) Diameter x length
Cut out	138 mm
Net weight	1.36 kgs
Warranty	1 year
Certifications	CE, RoHS
Electrical Data	
Charging Mode	Solar Energy. Round solar pannel with 4V/110mA output and size external diameter 100mm, and internal diameter 40mm
Battery	Battery Charging and Discharging Times 2000 at max. 3.2V/1100mah lithium battery. size 18*65mm
Charging Time	≥10h
Discharge Time	≥9h
Construction Data	
IP rating	IP67 Waterproof
IK rating	IK07
Housing	Solid Passivated (Anodizing) Aluminum CNC machined
Protection finishing	20~25µm thickness anodized film for housing. Dark grey
Trim	Stainless steel 316
Glass	Step tempered Glass. T=6mm.
Loading capacity	2000 kgs
Cable Gland	/
Gasket	O-ring PMQ silicone seal
Accessories	
Mounting sleeve	Anti-corrosion PVC
Packaging	
Inner box size	155*155*60 mm
Carton size	33.5*33.5*32.5 cm (20PCS / carton)



Specialized in Exterior LED Lighting

DECK LIGHTS/ WATERPROOF DOWNLIGHT SERIES

Products Features

These products are designed with stainless steel 316 trim, Solid 6063 Aluminum housing CNC machined, with passivated (anodizing) anti-corrosion finishing for housing, tempered glass for high loading capacity, silicone gasket and glue for waterproof IP65/IP67 and high quality CREE or OSRAM LED LED.

These products are with CE, RoHS certifications, and the SAA, PSE, UL or ETL certifications will be available in the coming future.

Application

These lights are widely used in the exterior or interior application, such as lighting road, architectural features, landscape features for the hotel, the garden, the park, the square, the stair step, the landscape road, outdoor ceiling, roof etc.



SSS 316

1 Year Warranty



IP65 IP67 IK06

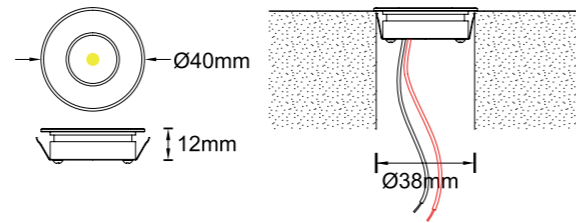


CE RoHS COMPLIANT IP65 IK06

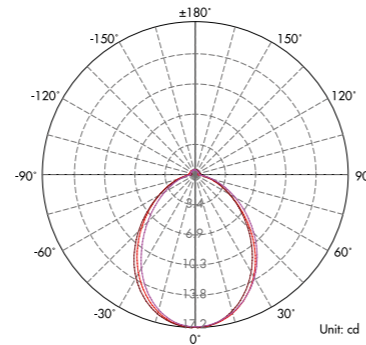
SSS 316 Passivated 1 Year Warranty

Parameter	
General Data	
Item No.	DL-1001-0100A-12V
Power	1 Watt
LED type	1 PC 1W OSRAM LED
Luminous flux	95~100 lm
CCT	2700K, 3000K, 4000K, 6000K, R/G/Y/B
CRI	80+
Beam angle	120°
Dimension	40 x 12 (mm) Diameter x Height
Cut out	38 mm
Net weight	0.080 kgs
Warranty	1 year
Certifications	CE, RoHS
Electrical Data	
Input voltage	DC12V/DC24V
Insulation class	Class III
Cable	1PC PVC cable 0.3M 2x0.34 mm square
Driver	Low voltage constant current output, excluding the transformer
Construction Data	
IP rating	IP65 Waterproof
IK rating	IK06
Housing	Solid Passivated (Anodizing) Aluminium CNC machined
Protection finishing	20~25µm thickness anodized film for housing.
Trim	Stainless steel 316 as standard, Polished chrome Aluminium as options
Glass	Step tempered Glass. T=4mm. Frosted glass as standard, milky white glass as options.
Loading capacity	320kgs
Cable Gland	Glue
Gasket	O-ring PMQ silicone seal +Glue
Accessories	
Mounting sleeve	Aluminium spring fixed on the body
Packaging	
Inner box size	70*45*45 mm
Carton size	38*36.5*24cm (200PCS / carton)

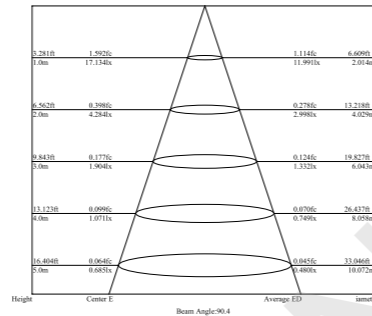
Dimension



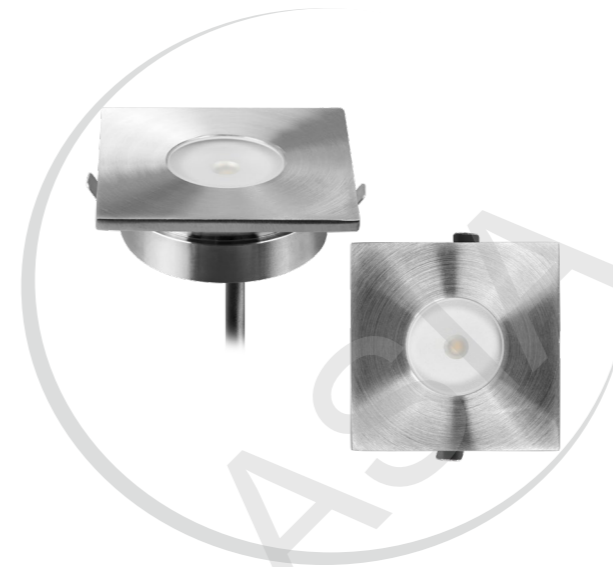
Light Distribution Curve (3000K, 120°)



Lux distance Curve (3000K, 120°)



Illumination Picture (120°)

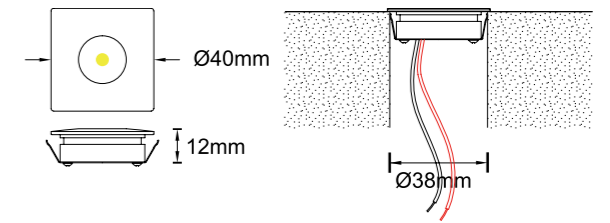


CE RoHS COMPLIANT IP65 IK06

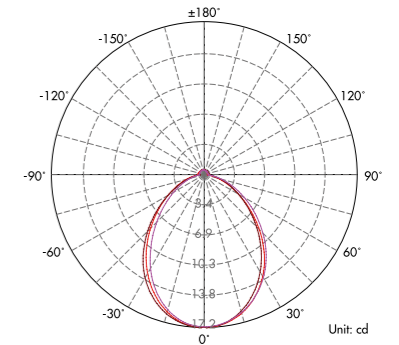
SSS 316 Passivated 1 Year Warranty

Parameter	
General Data	
Item No.	DL-1002-0100A-12V
Power	1 Watt
LED type	1 PC 1W OSRAM LED
Luminous flux	95~100 lm
CCT	2700K, 3000K, 4000K, 6000K, R/G/Y/B
CRI	80+
Beam angle	120°
Dimension	40 x 12 (mm) Diameter x Height
Cut out	38 mm
Net weight	0.086 kgs
Warranty	1 year
Certifications	CE, RoHS
Electrical Data	
Input voltage	DC12V/DC24V
Insulation class	Class III
Cable	1PC PVC cable 0.3M 2x0.34 mm square
Driver	Low voltage constant current output, excluding the transformer
Construction Data	
IP rating	IP65 Waterproof
IK rating	IK06
Housing	Solid Passivated (Anodizing) Aluminium CNC machined
Protection finishing	20~25µm thickness anodized film for housing.
Trim	Stainless steel 316 as standard, Polished chrome Aluminium as options
Glass	Step tempered Glass. T=4mm. Frosted glass as standard, milky white glass as options.
Loading capacity	320kgs
Cable Gland	Glue
Gasket	O-ring PMQ silicone seal +Glue
Accessories	
Mounting sleeve	Aluminium spring fixed on the body
Packaging	
Inner box size	70*45*45 mm
Carton size	38*36.5*24cm (200PCS / carton)

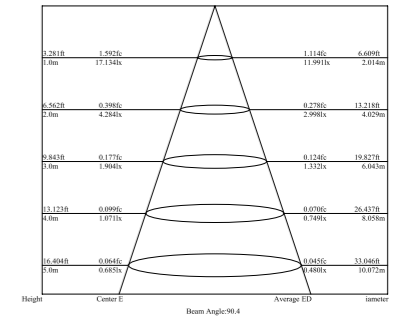
Dimension



Light Distribution Curve (3000K, 120°)



Lux distance Curve (3000K, 120°)



Illumination Picture (120°)





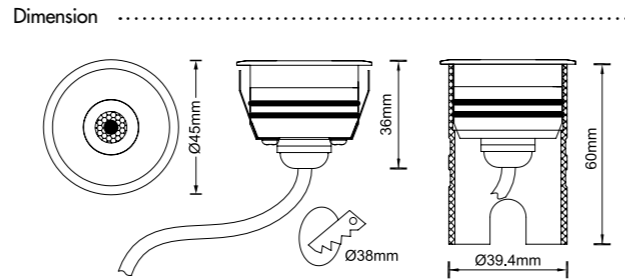


CE **RoHS COMPLIANT** **IP68 IK06**

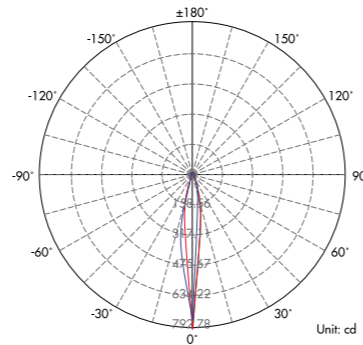
SSS 316 **Passivated** **1 Year Warranty**

For deck light, downlight, inground lights application !

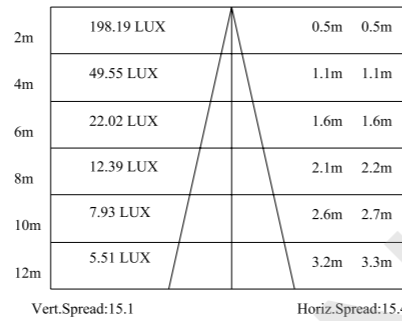
Parameter	
General Data	
Item No.	UL-1011-0100-A(Deck)
Power	1.5 Watts
LED type	1 PC CREE XPE LED
Luminous flux	90~95 lm
CCT	2700K, 3000K, 4000K, 6000K, R/G/B/A
CRI	80+
Beam angle	15°, 25°, 38°, 45°, 60°, 120° optional.
Dimension	45 x 36 (mm) Diameter x Height
Cut out	40 mm
Net weight	0.165 kgs
Warranty	1 year
Certifications	CE, RoHS
Electrical Data	
Input voltage	DC12V/DC24V
Insulation class	Class III
Cable	1PC rubber cable 1M H05RN-F 2x1mm square
Driver	Low voltage constant current output, excluding the transformer
Construction Data	
IP rating	IP68 Waterproof
IK rating	IK06
Housing	Solid Passivated (Anodizing) Aluminum CNC machined as standard, (Stainless steel 316 as options)
Protection finishing	20~25µm thickness anodized film for Aluminum housing.
Trim	Stainless steel 316
Glass	Step tempered Glass. T=4mm.
Loading capacity	320 kgs
Cable Gland	PG7 IP68, Glue
Gasket	O-ring PMQ silicone seal
Accessories	
Mounting Sleeve	Anti-corrosion grey PVC mounting sleeve as optional
Clip	With clip as deck light or downlight
Packaging	
Inner box size	95*60*55 mm
Carton size	40.5*32*30 cm (100PCS / carton)



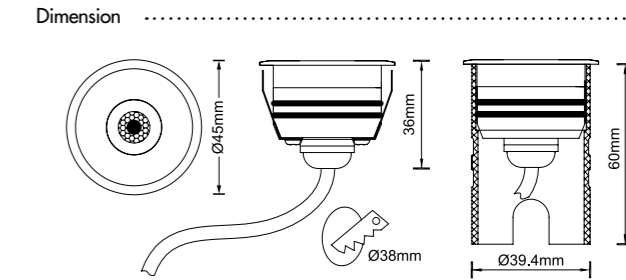
Light Distribution Curve (3000K, 25°)



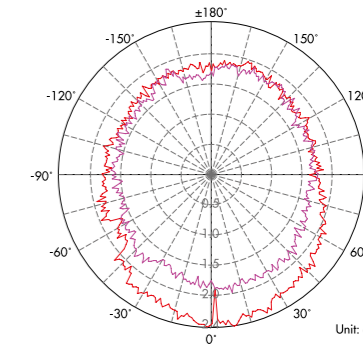
Lux distance Curve (3000K, 25°)



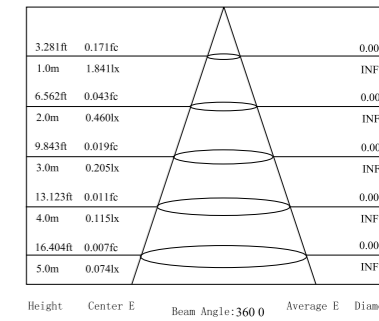
Illumination Picture (25°)



Light Distribution Curve (3000K, 120°)



Lux distance Curve (3000K, 120°)



Illumination Picture (120°)



CE **RoHS COMPLIANT** **IP68 IK06**

SSS 316 **Passivated** **1 Year Warranty**

For deck light, downlight, inground lights application !

Parameter	
General Data	
Item No.	UL-1011-0100-A(Milky White)
Power	1.5 Watts
LED type	1 PC CREE XPE LED
Luminous flux	60~70 lm
CCT	2700K, 3000K, 4000K, 6000K, R/G/B/A
CRI	80+
Beam angle	120° with milky white class
Dimension	45 x 36 (mm) Diameter x Height
Cut out	40 mm
Net weight	0.165 kgs
Warranty	1 year
Certifications	CE, RoHS
Electrical Data	
Input voltage	DC12V/DC24V
Insulation class	Class III
Cable	1PC rubber cable 1M H05RN-F 2x1mm square
Driver	Low voltage constant current output, excluding the transformer
Construction Data	
IP rating	IP68 Waterproof
IK rating	IK06
Housing	Solid Passivated (Anodizing) Aluminum CNC machined as standard, (Stainless steel 316 as options)
Protection finishing	20~25µm thickness anodized film for Aluminum housing.
Trim	Stainless steel 316
Glass	Step tempered Glass painted in milky white. T=4mm.
Loading capacity	320 kgs
Cable Gland	PG7 IP68, Glue
Gasket	O-ring PMQ silicone seal
Accessories	
Mounting Sleeve	Anti-corrosion grey PVC mounting sleeve as optional
Clip	With clip as deck light or downlight
Packaging	
Inner box size	95*60*55 mm
Carton size	40.5*32*30 cm (100PCS / carton)

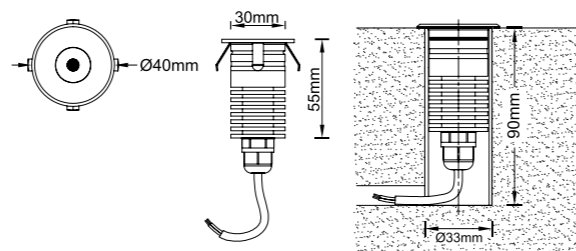


CE **RoHS COMPLIANT** **IP67 IK09**

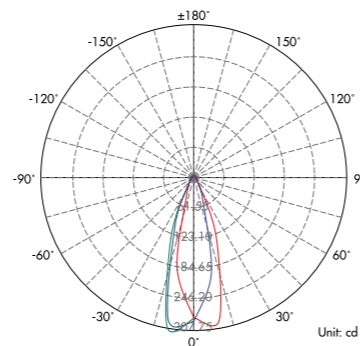
SSS 316 **Passivated** **1 Year Warranty**

Parameter	
General Data	
Item No.	UL-1003-0300-A(Deck)
Power	3 Watts
LED type	1 PC 3W CREE XPE LED
Luminous flux	110-130 lm
CCT	2700K, 3000K, 4000K, 6000K, R/G/Y/B
CRI	80+
Beam angle	5°, 10°, 17°, 23°, 28°, 43°, 58° or Asymmetric 15°x15°, 15°x25°, 15°x30°, 15°x45°, 15°x60°
Dimension	Ø40x55 (mm) Diameter x length
Cut out	33 mm
Net weight	0.23 kgs
Warranty	1 year
Certifications	CE, RoHS
Electrical Data	
Input voltage	DC 12V-DC24V
Insulation class	Class III
Cable	1PC rubber cable 1M H05RN-F 2x1mm square
Driver	Low voltage constant current output, excluding the transformer
Construction Data	
IP rating	IP67 Waterproof
IK rating	IK09
Housing	Solid Passivated (Anodizing) Aluminum CNC machined
Protection finishing	20-25µm thickness anodized film for housing. Dark grey
Trim	Stainless steel 316
Glass	Step tempered Glass. T=10mm.
Loading capacity	500 kgs
Cable Gland	PG7 IP67
Gasket	O-ring PMQ silicone seal
Accessories	
Mounting Sleeve	Aluminum Sleeve as options for inground light
Clip	With Aluminium spring that's for deck lights or ceiling lights application
Packaging	
Inner box size	110*85*60 mm
Carton size	44*24*32 cm (50PCS / carton)

Dimension



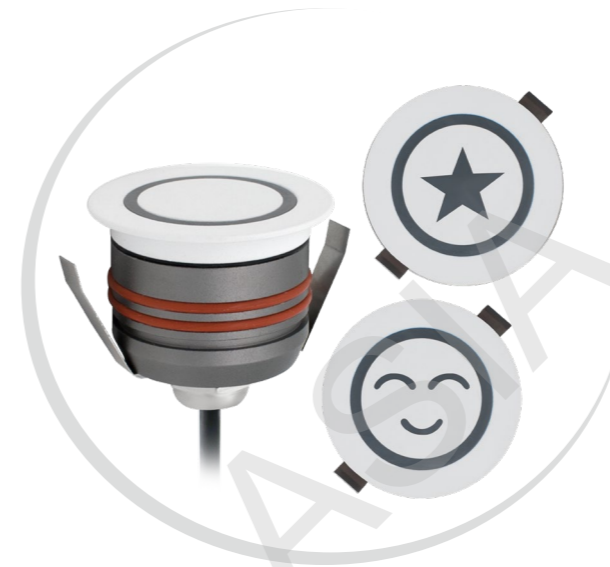
Light Distribution Curve (3000K, 1x40°)



Lux distance Curve (3000K, 1x40°)

Distance (m)	1.0m	2.0m	3.0m	4.0m	5.0m	6.0m	8.0m	10m	12m
Lux	71.23	17.81	7.91	4.45	2.85	1.98			

Illumination Picture (1x40°)



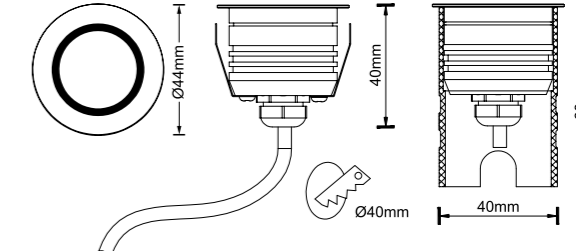
CE **RoHS COMPLIANT** **IP67 IK07**

SSS 316 **1 Year Warranty**

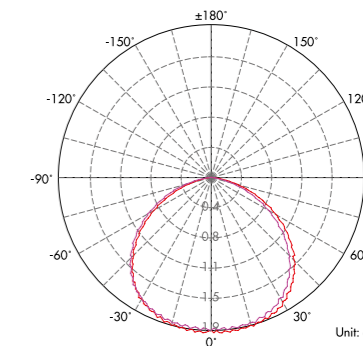
The icon / logo of the trim can be customized!

Parameter	
General Data	
Item No.	UL-E004-0200-A(deck)
Power	2 Watts +10%
LED type	1PC 2W OSRAM LED
Luminous flux	12lm +10%
CCT	2700K, 3000K, 4000K, 6000K, R/G/Y/B
CRI	80+
Beam angle	120°
Dimension	Ø44 x 40 (mm) Diameter x length
Cut out	40 mm
Net weight	0.23 kgs
Warranty	1 year
Certifications	CE, RoHS
Electrical Data	
Input voltage	DC24V
Insulation class	Class III
Cable	1PC rubber cable 0.3M H05RN-F 2 x0.5mm square
Driver	Low voltage input constant current output
Construction Data	
IP rating	IP67 Waterproof
IK rating	IK07
Housing	Solid Passivated (Anodizing) Aluminum CNC machined
Protection finishing	20-25µm thickness anodized film for housing, silver color as standard, dark grey optional.
Trim	Stainless steel 316 in white color or original 316 color The icon / logo of the trim can be customized
Glass	/
Loading capacity	500 kgs
Cable Gland	PG gland
Gasket	O-ring PMQ silicone seal
Accessories	
Mounting Sleeve	With mounting sleeve PVC as options used as inground light
Clip	With 2 clips as deck light or ceiling light
Packaging	
Inner box size	140*140*60 mm
Carton size	30.5*30.5*20.5CM (12PCS/CTN)

Dimension



Light Distribution Curve (3000K, 120°)



Lux distance Curve (3000K, 120°)

Distance (m)	0.171m	0.342m	0.513m	0.684m	0.855m	1.026m	1.197m	1.368m	1.539m	1.710m	1.881m	2.052m	2.223m	2.394m	2.565m	2.736m	2.907m	3.078m	3.249m
Lux	3.281	1.843	0.643	0.461	0.205	0.115	0.074												

Illumination Picture (120°)





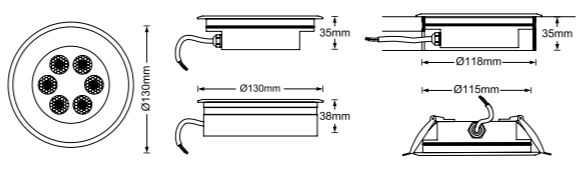


CE RoHS COMPLIANT IP67 IK08

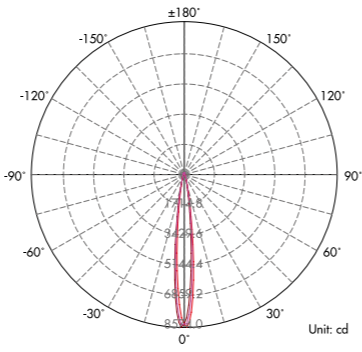
Ultra slim Passivated 1 Year Warranty

Parameter	
General Data	
Item No.	UL-6001-09001
Power	9 Watts
LED type	6 PCS OSRAM SMD LED
Luminous flux	480-540lm
CCT	2700K, 3000K, 4000K, 6000K
CRI	80+
Beam angle	Symmetric: 5°, 10°, 17°, 23°, 28°, 43°, 58° Asymmetric: 15°x25°, 15°x30°, 15°x45°, 15°x60° (tilt +pan)
Dimension	Ø130x35 (mm) Diameter x Height
Cut out	Inground light: Ø118 mm Deck light: Ø115 mm
Net weight	0.72 KGS
Warranty	1 year
Certifications	CE, RoHS
Electrical Data	
Input voltage	DC 24V
Insulation class	Class III
Cable	1PC rubber cable 1M H05RN-F 2x1mm square
Driver	Built-in low voltage constant current driver without transformer
Control	ON\OFF / PWM
Construction Data	
IP rating	IP67 Waterproof
IK rating	IK08
Housing	Solid Passivated (Anodizing) Aluminum CNC machined
Protection finishing	20~25µm thickness anodized film for housing. Dark grey color
Trim	Stainless steel 316
Glass	Step tempered Glass. T=8mm.
Loading capacity	2000 kgs
Cable Gland	PG7 IP67
Gasket	O-ring PMQ silicone seal
Accessories	
Mounting sleeve	Aluminium sleeve used as inground light
Clip	Two clips with screws optional used as downlight / deck light
Packaging	
Inner box size	140*140*60 mm
Carton size	30.5*30.5*20.5CM. (112PCS/CTN)

Dimension



Light Distribution Curve (3000K,17°)



Lux distance Curve (3000K,17°)

Height	Center E	Beam Angle: 1 2 0	Average E	Diameter
3.281ft	779.02fc		564.662fc	0.687ft
1.0m	8385.4lx		6078.021lx	0.209m
6.562ft	194.75fc		141.165fc	1.374ft
2.0m	2096.3lx		1519.505lx	0.419m
9.843ft	86.558fc		62.740fc	2.061ft
3.0m	931.71lx		675.336lx	0.628m
13.123ft	48.689fc		35.291fc	2.748ft
4.0m	524.09lx		379.876lx	0.837m
16.404ft	31.161fc		22.586fc	3.434ft
5.0m	335.41lx		243.121lx	1.047m

Illumination Picture (17°)

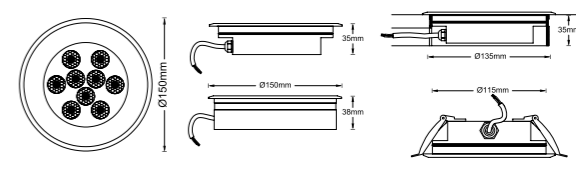


CE RoHS COMPLIANT IP67 IK08

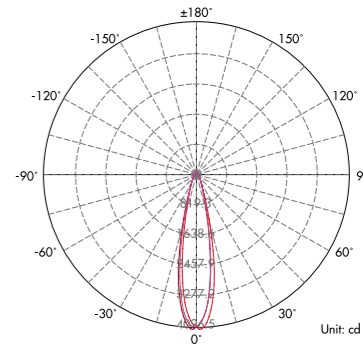
Ultra slim Passivated 1 Year Warranty

Parameter	
General Data	
Item No.	UL-9001-12001
Power	12 Watts
LED type	9 PCS OSRAM SMD LED
Luminous flux	720-810lm
CCT	2700K, 3000K, 4000K, 6000K
CRI	80+
Beam angle	Symmetric: 5°, 10°, 17°, 23°, 28°, 43°, 58° Asymmetric: 15°x25°, 15°x30°, 15°x45°, 15°x60° (tilt +pan)
Dimension	Ø150x35 (mm) Diameter x Height
Cut out	Inground light: Ø135mm Deck light: Ø135mm
Net weight	0.98 KGS
Warranty	1 year
Certifications	CE, RoHS
Electrical Data	
Input voltage	DC 24V
Insulation class	Class III
Cable	1PC rubber cable 1M H05RN-F 2x1mm square
Driver	Built-in low voltage constant current driver without transformer
Control	ON\OFF / PWM
Construction Data	
IP rating	IP67 Waterproof
IK rating	IK08
Housing	Solid Passivated (Anodizing) Aluminum CNC machined
Protection finishing	20~25µm thickness anodized film for housing. Dark grey color
Trim	Stainless steel 316
Glass	Step tempered Glass. T=8mm.
Loading capacity	2000 kgs
Cable Gland	PG7 IP67
Gasket	O-ring PMQ silicone seal
Accessories	
Mounting sleeve	Aluminium sleeve optional used as inground light
Clip	Two clips with screws used as downlight / deck light
Packaging	
Inner box size	160*160*60 mm
Carton size	34.5*34.5*20.5CM (112PCS/CTN)

Dimension



Light Distribution Curve (3000K,17°)



Lux distance Curve (3000K,17°)

Height	Center E	Beam Angle: 22 1	Average E	Diameter
3.281ft	375.03fc		268.211fc	1.281ft
1.0m	4036.8lx		2887.028lx	0.390m
6.562ft	93.757fc		67.053fc	2.562ft
2.0m	1009.2lx		721.757lx	0.781m
9.843ft	41.670fc		29.801fc	3.843ft
3.0m	448.54lx		320.781lx	1.171m
13.123ft	23.439fc		16.763fc	5.124ft
4.0m	252.30lx		180.439lx	1.562m
16.404ft	15.001fc		10.728fc	6.405ft
5.0m	161.47lx		115.481lx	1.952m

Illumination Picture (10°)



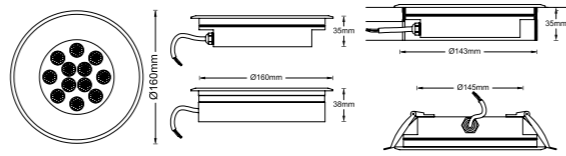


CE RoHS COMPLIANT IP67 IK08

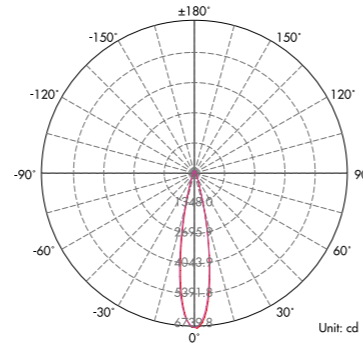
Ultra slim Passivated 1 Years Warranty

Parameter	
General Data	
Item No.	UL-1201-1500H
Power	1.5 Watts
LED type	12 PCS OSRAM SMD LED
Luminous flux	960-1080lm
CCT	2700K, 3000K, 4000K, 6000K
CRI	80+
Beam angle	Symmetric: 5°, 10°, 17°, 23°, 28°, 43°, 58° Asymmetric: 15°x25°, 15°x30°, 15°x45°, 15°x60° (filt +pan)
Dimension	Ø160x35 (mm) Diameter x Height
Cut out	Inground light: (143mm Deck light.) 145mm
Net weight	1.1 KGS
Warranty	1 year
Certifications	CE, RoHS
Electrical Data	
Input voltage	DC 24V
Insulation class	Class III
Cable	1PC rubber cable 1M H05RN-F 2x1mm square
Driver	Built-in low voltage constant current driver without transformer
Control	ON/OFF / PWM
Construction Data	
IP rating	IP67 Waterproof
IK rating	IK08
Housing	Solid Passivated (Anodizing) Aluminum CNC machined
Protection finishing	20~25µm thickness anodized film for housing. Dark grey color
Trim	Stainless steel 316
Glass	Step tempered Glass. T=8mm.
Loading capacity	2000 kgs
Cable Gland	PG7 IP67
Gasket	O-ring PMQ silicone seal
Accessories	
Mounting sleeve	Aluminium sleeve optional used as inground light
Clip	Two clips with screws used as downlight / deck light
Packaging	
Inner box size	170*170*60 mm
Carton size	36.5*36.5*14CM (8PCS/CTN)

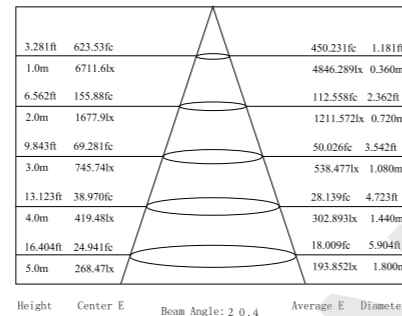
Dimension



Light Distribution Curve (3000K,10°)



Lux distance Curve (3000K,10°)



Illumination Picture (10°)



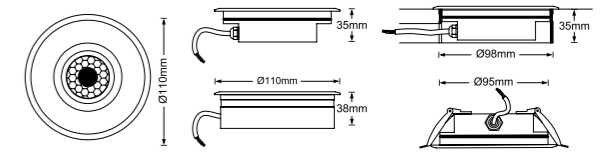
CE RoHS COMPLIANT IP67 IK08

SSS 316 1 Year Warranty

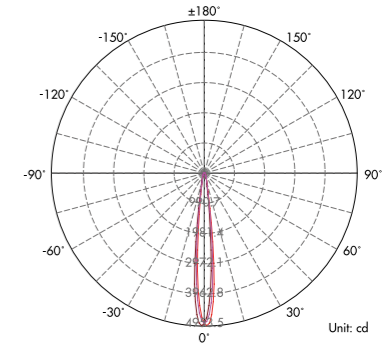
Used as inground lights, downlights, deck lights !

Parameter	
General Data	
Item No.	UL-6W-COB-0600H
Power	6 Watts +10%
LED type	1 PC 6W CREE COB LED
Luminous flux	415lm ~435lm +10%
CCT	2700K, 3000K, 4000K, 6000K
CRI	80+
Beam angle	10°, 20°, 30°
Dimension	Ø110x35 (mm) Diameter x length
Cut out	98 mm with sleeve, 95mm with clip
Net weight	0.55 kgs
Warranty	1 year
Certifications	CE, RoHS
Electrical Data	
Input voltage	DC24V
Insulation class	Class III
Cable	1PC rubber cable 1M H05RN-F 2x1mm square
Driver	Low voltage constant current output, excluding the transformer
Construction Data	
IP rating	IP67 Waterproof
IK rating	IK08
Housing	Solid Passivated (Anodizing) Aluminum CNC machined
Protection finishing	20~25µm thickness anodized film for housing. Dark grey
Trim	Stainless steel 316
Glass	Step tempered Glass. T=8mm.
Loading capacity	500 kgs
Cable Gland	PG gland
Gasket	O-ring PMQ silicone seal
Accessories	
Mounting sleeve	Passivated (Anodizing) Aluminum CNC machined. Dark grey
Clip	With spring as options, that's for wall lights, deck lights or ceiling lights application
Packaging	
Inner box size	120*120*60 mm
Carton size	38.5*26.5*20.5 cm (18 PCS / carton)

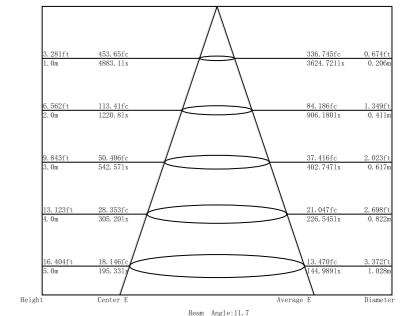
Dimension



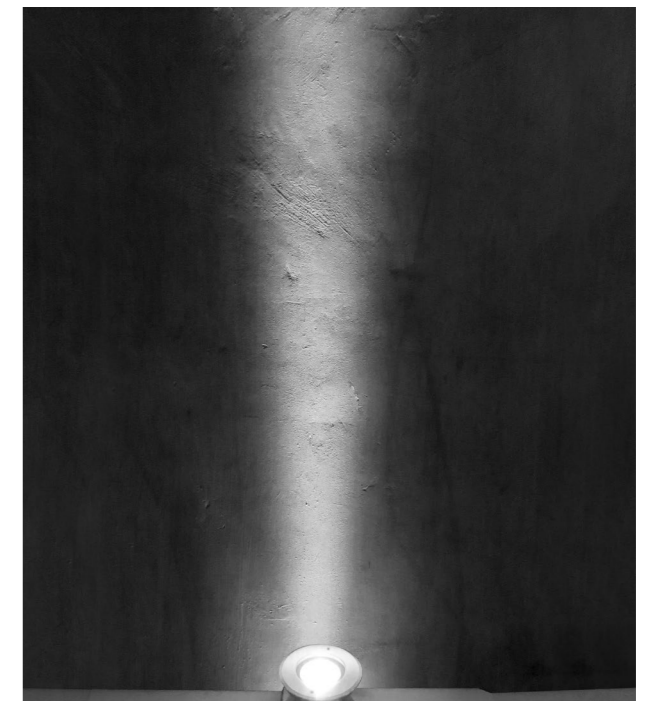
Light Distribution Curve (3000K,10°)



Lux distance Curve (3000K,10°)

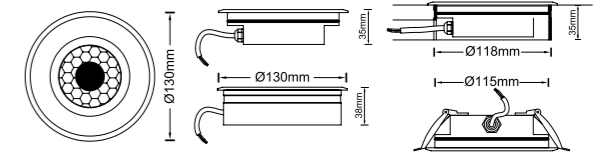


Illumination Picture (10°)

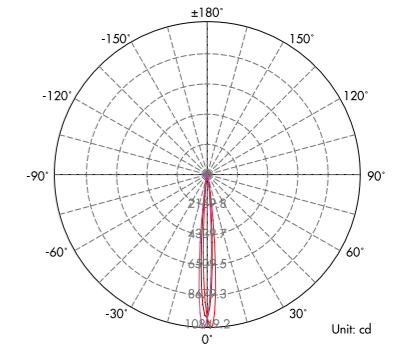




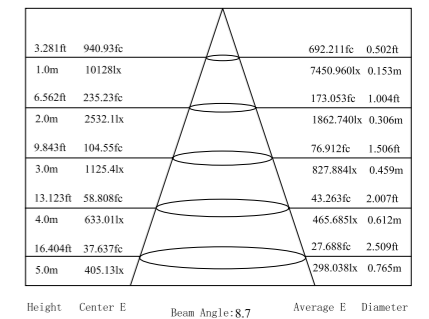
Dimension



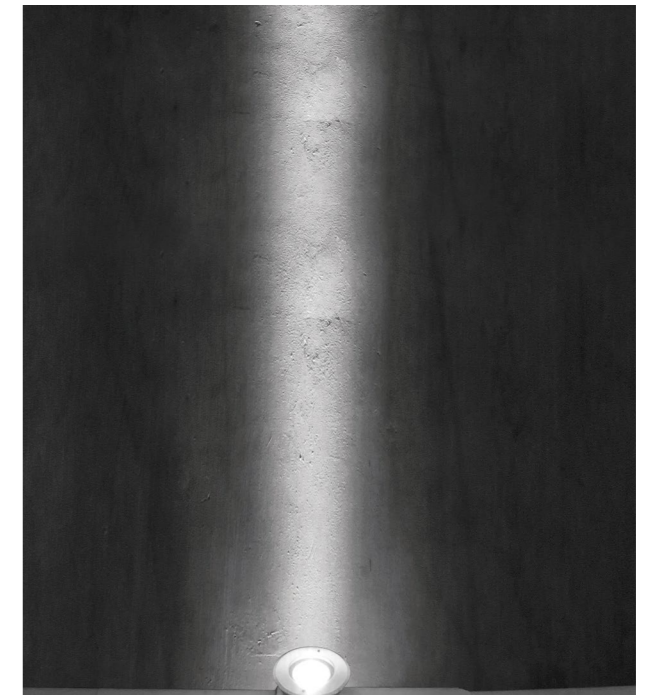
Light Distribution Curve (3000K,10°)



Lux distance Curve (3000K,10°)



Illumination Picture (10°)



CE RoHS COMPLIANT IP67 IK08

Ultra slim Passivated 1 Year Warranty

Parameter

General Data	
Item No.	UL-9W-COB-09004
Power	9 Watts
LED type	1 PC 9W CREE COB LED
Luminous flux	Clear glass: 435-490lm; Middle black painting glass: 345-445lm
CCT	2700K, 3000K, 4000K, 6000K
CRI	80+
Beam angle	10°, 20°, 30°
Dimension	Ø130x35 (mm) Diameter x Height
Cut out	Inground light: Ø118 mm Deck light: Ø115 mm
Net weight	0.72 KGS
Warranty	1 year
Certifications	CE, RoHS
Electrical Data	
Input voltage	DC 24V
Insulation class	Class III
Cable	1PC rubber cable 1M H05RN-F 2x1mm square
Driver	Built-in low voltage constant current driver without transformer
Control	ON/OFF / PWM
Construction Data	
IP rating	IP67 Waterproof
IK rating	IK08
Housing	Solid Passivated (Anodizing) Aluminum CNC machined
Protection finishing	20~25µm thickness anodized film for housing. Dark grey color
Trim	Stainless steel 316
Glass	Step tempered clear glass as standard T=8mm. (middle black painting glass optional)
Loading capacity	2000 kgs
Cable Gland	PG7 IP67
Gasket	O-ring PMQ silicone seal
Accessories	
Mounting sleeve	Aluminium sleeve optional used as inground light
Clip	Two clips with screws used as downlight / deck light
Packaging	
Inner box size	140*140*60 mm
Carton size	30.5*30.5*20.5CM (112PCS/CTN)

DECK LIGHTS \ МАТЕБЪРЪОФ ДОМИЛННТ СЕРИЕС



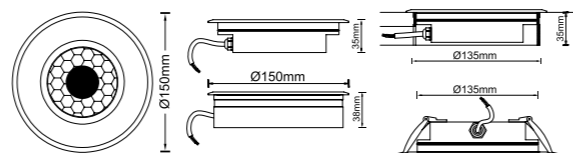
CE RoHS COMPLIANT IP67 IK08

Ultra slim Passivated 1 Year Warranty

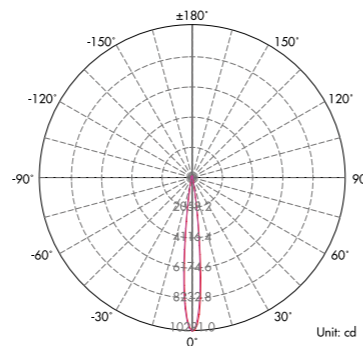
Parameter

General Data	
Item No.	UL-12W-COB-1200H
Power	12 Watts
LED type	1 PC 12W CREE COB LED
Luminous flux	Clear glass: 830~950lm; Middle black painting glass: 470~600lm
CCT	2700K, 3000K, 4000K, 6000K
CRI	80+
Beam angle	10°, 20°, 30°
Dimension	Ø150x35 (mm) Diameter x Height
Cut out	Inground light: Ø135mm Deck light: Ø135mm
Net weight	0.98 KGS
Warranty	1 year
Certifications	CE, RoHS
Electrical Data	
Input voltage	DC 24V
Insulation class	Class III
Cable	1PC rubber cable 1M H05RN-F 2x1mm square
Driver	Built-in low voltage constant current driver without transformer
Control	ON\OFF / PWM
Construction Data	
IP rating	IP67 Waterproof
IK rating	IK08
Housing	Solid Passivated (Anodizing) Aluminum CNC machined
Protection finishing	20~25µm thickness anodized film for housing. Dark grey color
Trim	Stainless steel 316
Glass	Step tempered clear glass as standard T=8mm. (middle black painting glass optional)
Loading capacity	2000 kgs
Cable Gland	PG7 IP67
Gasket	O-ring PMQ silicone seal
Accessories	
Mounting sleeve	Aluminium sleeve optional used as inground light
Clip	Two clips with screws used as downlight / deck light
Packaging	
Inner box size	160*160*60 mm
Carton size	34.5*34.5*20.5cm (12PCS/CTN)

Dimension



Light Distribution Curve (3000K, 10°)



Lux distance Curve (3000K, 10°)

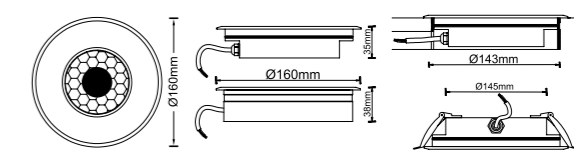
3.281ft	956.06fc	700.367fc	0.662ft
1.0m	10291lx	7538.750lx	0.202m
6.562ft	239.01fc	175.092fc	1.323ft
2.0m	2572.8lx	1884.687lx	0.403m
9.843ft	106.23fc	77.819fc	1.985ft
3.0m	1143.4lx	837.639lx	0.605m
13.123ft	59.754fc	43.773fc	2.646ft
4.0m	643.19lx	471.172lx	0.807m
16.404ft	38.242fc	28.015fc	3.308ft
5.0m	411.64lx	301.550lx	1.008m

Height Center E Beam Angle: 11.5 Average E Diameter

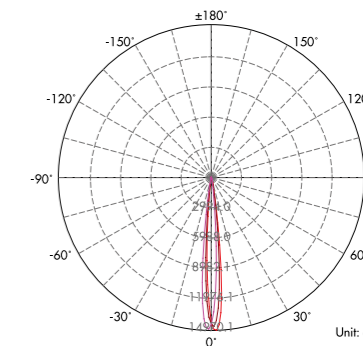
Illumination Picture (30°)



Dimension



Light Distribution Curve (3000K, 20°)

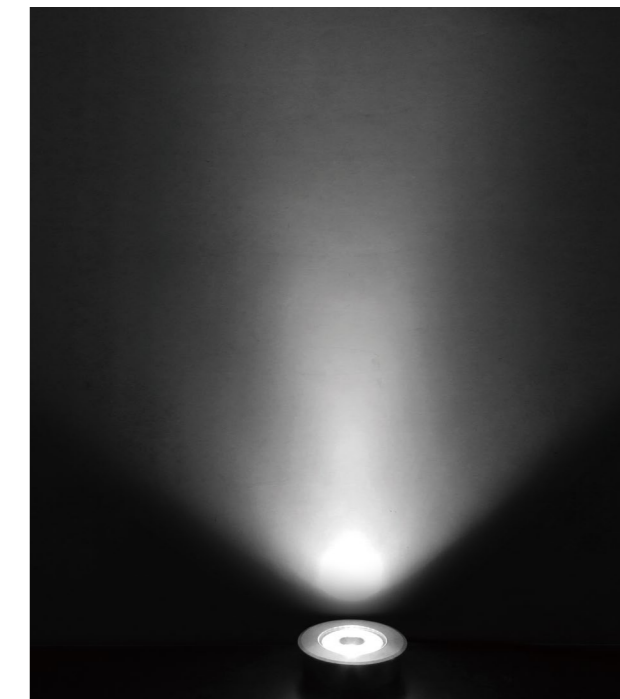


Lux distance Curve (3000K, 20°)

3.281ft	1332.5fc	962.453fc	0.572ft
1.0m	14343lx	10359.844lx	0.174m
6.562ft	333.13fc	240.613fc	1.143ft
2.0m	3585.8lx	2589.961lx	0.348m
9.843ft	148.06fc	106.939fc	1.715ft
3.0m	1593.7lx	1151.094lx	0.523m
13.123ft	83.282fc	60.153fc	2.287ft
4.0m	896.45lx	647.490lx	0.697m
16.404ft	53.301fc	38.498fc	2.858ft
5.0m	573.73lx	414.394lx	0.871m

Height Center E Beam Angle: 10.0 Average E Diameter

Illumination Picture (20°)



CE RoHS COMPLIANT IP67 IK08

Ultra slim Passivated 1 Year Warranty

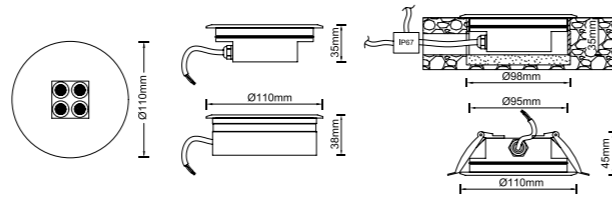
Parameter

General Data	
Item No.	UL-15W-COB-1500H
Power	15 Watts
LED type	1 PC 15W CREE COB LED
Luminous flux	Clear glass: 1000~1060lm; Middle black painting glass: 650~900lm
CCT	2700K, 3000K, 4000K, 6000K
CRI	80+
Beam angle	10°, 20°, 30°
Dimension	Ø160x35 (mm) Diameter x Height
Cut out	Inground light: Ø143mm Deck light: Ø145mm
Net weight	1.1 KGS
Warranty	1 year
Certifications	CE, RoHS
Electrical Data	
Input voltage	DC 24V
Insulation class	Class III
Cable	1PC rubber cable 1M H05RN-F 2x1mm square
Driver	Built-in low voltage constant current driver without transformer
Control	ON\OFF / PWM
Construction Data	
IP rating	IP67 Waterproof
IK rating	IK08
Housing	Solid Passivated (Anodizing) Aluminum CNC machined
Protection finishing	20~25µm thickness anodized film for housing. Dark grey color
Trim	Stainless steel 316
Glass	Step tempered clear glass as standard T=8mm. (middle black painting glass optional)
Loading capacity	2000 kgs
Cable Gland	PG7 IP67
Gasket	O-ring PMQ silicone seal
Accessories	
Mounting sleeve	Aluminium sleeve optional used as inground light
Clip	Two clips with screws used as downlight / deck light
Packaging	
Inner box size	170*170*60 mm
Carton size	36.5*36.5*14cm (8PCS/CTN)

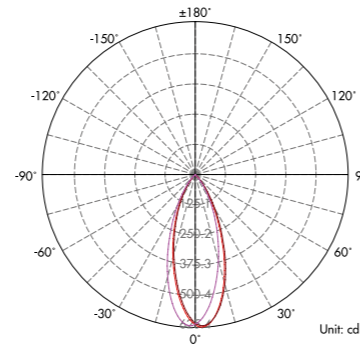
Slim Deep 6W



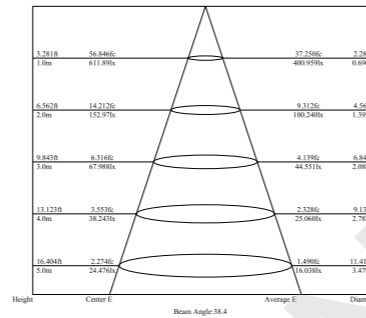
Dimension



Light Distribution Curve (3000K,40°)



Lux distance Curve (3000K,40°)



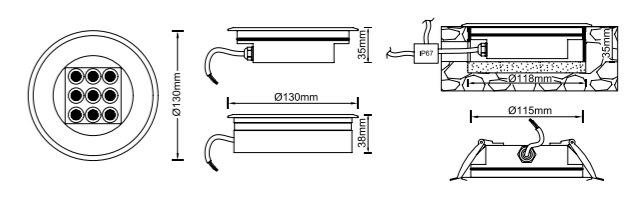
Illumination Picture (40°)



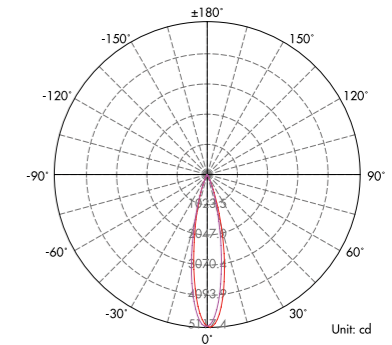
Slim Deep 12W



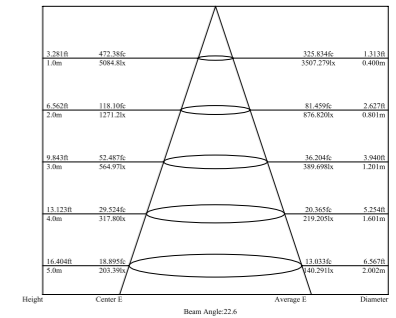
Dimension



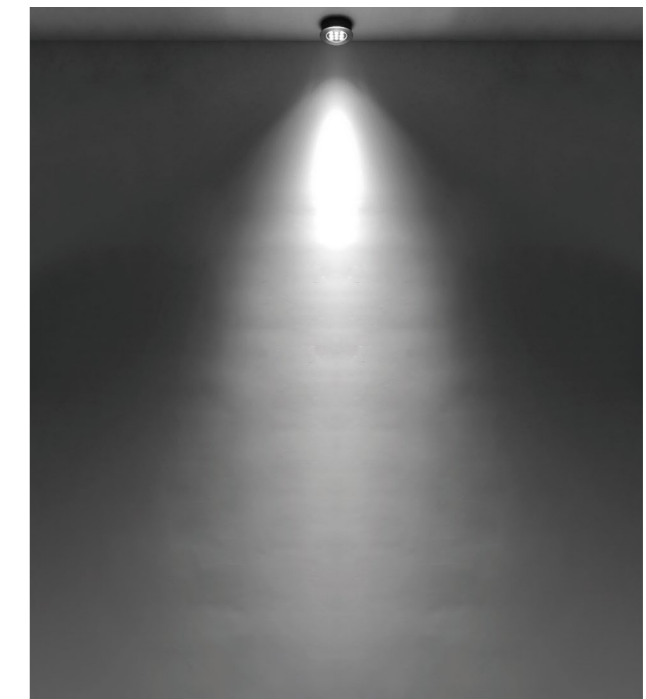
Light Distribution Curve (3000K,24°)



Lux distance Curve (3000K,24°)



Illumination Picture (24°)



CE RoHS COMPLIANT IP67 IK08

SSS 316 1 Year Warranty

Used as inground lights, downlights, deck lights!

Parameter

General Data	
Item No.	UL-4001-0600E (deck)
Power	6 Watts ± 10%
LED type	4 PCS 1.5V OSRAM 3030 LED
Luminous flux	500lm ± 10%
CCT	2700K, 3000K, 4000K, 6000K
CRI	80+
Beam angle	15°, 24°, 40°
Dimension	Ø110x35 (mm) Diameter x length
Cut out	98 mm with sleeve, 95mm with clip
Net weight	0.58 kgs
Warranty	1 year
Certifications	CE, RoHS
Electrical Data	
Input voltage	DC24V
Insulation class	Class III
Cable	1PC rubber cable 1M H05RN-F 2x1mm square
Driver	Low constant voltage input driver, constant current output for LEDs
Construction Data	
IP rating	IP67 Waterproof
IK rating	IK08
Housing	Solid Passivated (Anodizing) Aluminum CNC machined
Protection finishing	20~25µm thickness anodized film for housing. Dark grey
Trim	Stainless steel 316
Glass	Step tempered Glass. T=8mm.
Loading capacity	500 kgs
Cable Gland	PG gland
Gasket	O-ring PMQ silicone seal
Accessories	
Mounting Sleeve	Passivated (Anodizing) Aluminum CNC machined. Dark grey
Clip	With spring as options, that's for wall lights, deck lights or ceiling lights application
Packaging	
Inner box size	120*120*60 mm
Carton size	38.5*26.5*20.5 cm (18 PCS / carton)

CE RoHS COMPLIANT IP67 IK08

SSS 316 1 Year Warranty

Used as inground lights, downlights, deck lights!

Parameter

General Data	
Item No.	UL-9001-1200E (deck)
Power	12 Watts ± 10%
LED type	9 PCS 1.3V OSRAM 3030 LED
Luminous flux	1000lm ± 10%
CCT	2700K, 3000K, 4000K, 6000K
CRI	80+
Beam angle	15°, 24°, 40°
Dimension	Ø130x35 (mm) Diameter x length
Cut out	118 mm with sleeve, 115mm with clip
Net weight	0.75 kgs
Warranty	1 year
Certifications	CE, RoHS
Electrical Data	
Input voltage	DC24V
Insulation class	Class III
Cable	1PC rubber cable 1M H05RN-F 2x1mm square
Driver	Low constant voltage input driver, constant current output for LEDs
Construction Data	
IP rating	IP67 Waterproof
IK rating	IK08
Housing	Solid Passivated (Anodizing) Aluminum CNC machined
Protection finishing	20~25µm thickness anodized film for housing. Dark grey
Trim	Stainless steel 316
Glass	Step tempered Glass. T=8mm.
Loading capacity	500 kgs
Cable Gland	PG gland
Gasket	O-ring PMQ silicone seal
Accessories	
Mounting Sleeve	Passivated (Anodizing) Aluminum CNC machined. Dark grey
Clip	With spring as options, that's for wall lights, deck lights or ceiling lights application
Packaging	
Inner box size	140*140*60 mm
Carton size	30.5*30.5*20.5 cm (12 PCS / carton)





Specialized in Exterior LED Lighting

UNDERWATER LIGHTS SERIES

Products Features

These products are designed with stainless steel 316 trim, stainless steel 316 housing for underwater anti-corrosion, optics PMMA lens with wonderful light output, tempered glass for high loading capacity, silicone gasket and cable gland for waterproof IP67 and high quality CREE LED, OSRAM LED, EPISTAR LED. We also use the nylon materials mounting sleeve so that it can be strong enough for recessing in the wall of the pool.

We design the underwater lights for recessed installation for pool, standing surface mounted for fountain, surface mounted for boat or pool.

These products are with CE, RoHS certifications, and the SAA, PSE, UL or ETL certifications will be available in the coming future.

Application

These lights are widely used in the underwater application, such as the pool, the fountain, boats etc.

SSS 316

Adjustable

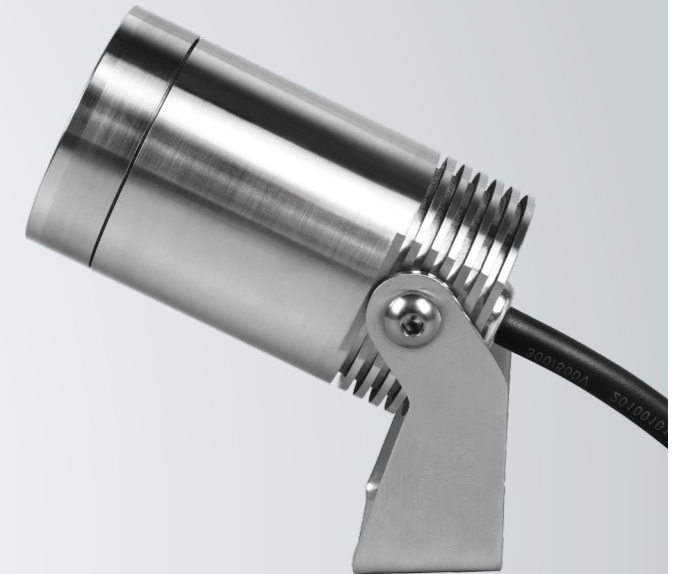
Passivated

1 Year Warranty

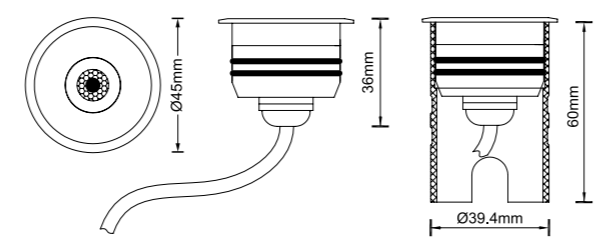


IP67 IK06 IK07 IK08

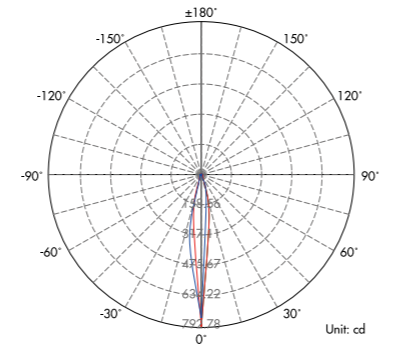
IK09 IK10



Dimension



Light Distribution Curve (3000K, 25°)



Lux distance Curve (3000K, 25°)

Distance (m)	Illuminance at a Distance	
	Center Beam LUX	Beam Width V H
2m	198.19 LUX	0.5m 0.5m
4m	49.55 LUX	1.1m 1.1m
6m	22.02 LUX	1.6m 1.6m
8m	12.39 LUX	2.1m 2.2m
10m	7.93 LUX	2.6m 2.7m
12m	5.51 LUX	3.2m 3.3m

Vert.Spread:15.1 Horiz.Spread:15.4

Illumination Picture (25°)



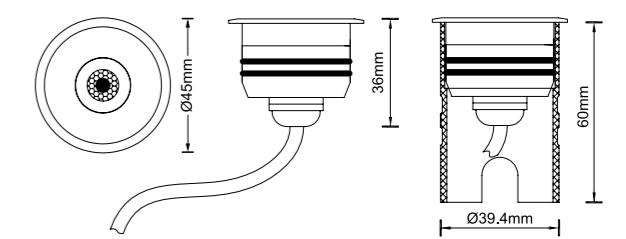
CE RoHS COMPLIANT IP68 IK06
SSS 316 1 Year Warranty

RGB
Use only in permanent immersion in water as to avoid damaging to LED!

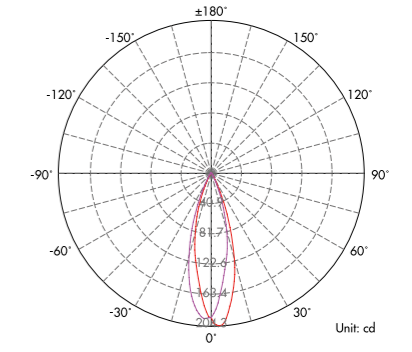
Parameter

General Data	
Item No.	UL-1011-0100 (RGB)A
Power	3 Watts
LED type	1PC 3030 RGB LED
Luminous flux	/
CCT	RGB
CRI	/
Beam angle	15°, 25°, 38°, 45°, 60°, 120°
Dimension	Ø45 x 36 (mm) Diameter x length
Cut out	40 mm
Net weight	0.18 kgs
Warranty	1 year
Certifications	CE, RoHS
Electrical Data	
Input voltage	DC 12V
Insulation class	Class III
Cable	1PC rubber cable 1M HO5RNF 5x0.5mm square
Driver	Low voltage input, constant current output, excluding the transformer
Construction Data	
IP rating	IP68 Waterproof
IK rating	IK06
Housing	Stainless steel 316
Protection finishing	Stainless steel 316
Trim	Stainless steel 316
Glass	Step tempered Glass. T=4mm.
Loading capacity	320 kgs
Cable Gland	PG gland
Gasket	O-ring PMQ silicone seal
Accessories	
Mounting Sleeve	Anti-corrosion grey PVC tube (Convex type box as options)
Packaging	
Inner box size	95*60*55 mm
Carton size	40.5*32*30 cm (100 PCS / carton)

Dimension



Light Distribution Curve (RGB, 45°)

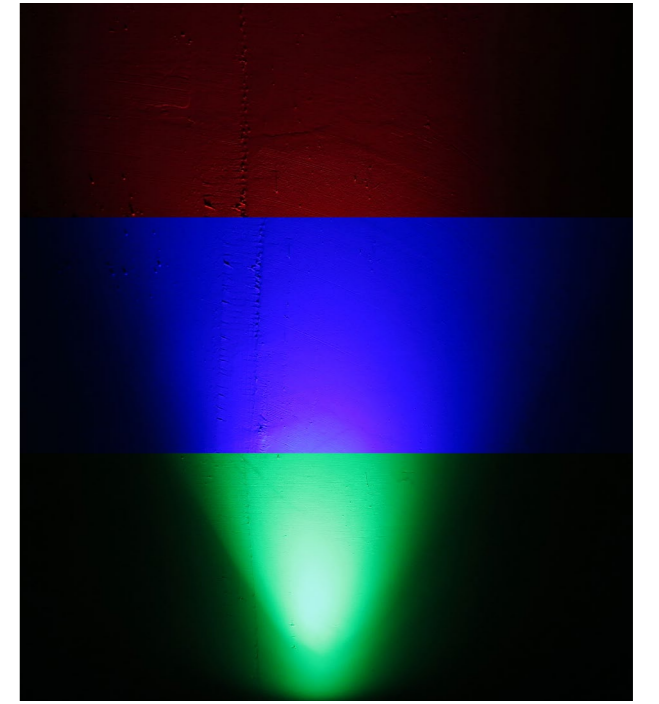


Lux distance Curve (RGB, 45°)

Distance (m)	Illuminance at a Distance	
	Center Beam LUX	Beam Width V H
2m	198.19 LUX	1.1m 1.1m
4m	49.55 LUX	2.2m 2.2m
6m	22.02 LUX	3.3m 3.3m
8m	12.39 LUX	4.4m 4.4m
10m	7.93 LUX	5.5m 5.5m
12m	5.51 LUX	6.6m 6.6m

Vert.Spread:15.1 Horiz.Spread:15.4

Illumination Picture (45°)

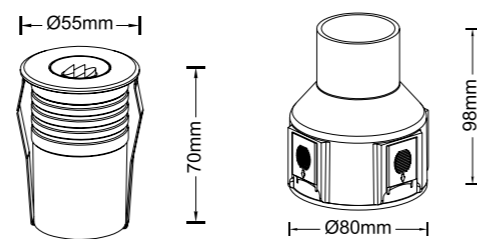


UNDERWATER LIGHTS SERIES

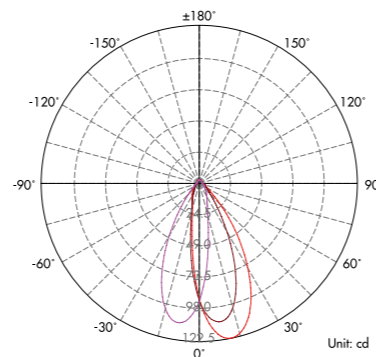
UNDERWATER LIGHTS SERIES



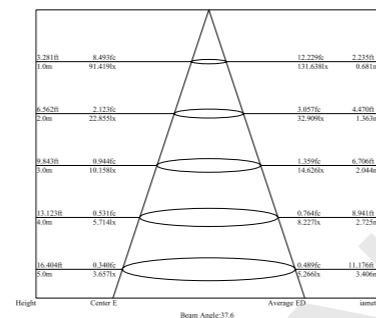
Dimension



Light Distribution Curve (3000K, 15x30°)



Lux distance Curve (3000K, 15x30°)



Illumination Picture (15x30°)



CE RoHS COMPLIANT IP68 IK06

SSS 316 Passivated 1 Year Warranty

Asymmetric lens

Parameter

General Data	
Item No.	UL-1009-0300C-316
Power	3 Watts
LED type	1 PC 3W CREE XPE LED
Luminous flux	110~130 lm
CCT	2700K, 3000K, 4000K, 6000K, R/G/Y/B
CRI	80+
Beam angle	Asymmetric: 15°+15°, 15°+25°, 15°+30°, 15°+45°, 15°+60°; Symmetric: 5°, 10°, 17°, 23°, 28°, 43°, 58°
Dimension	55x70 (mm) Diameter x Height
Cut out	80 mm
Net weight	0.356 kgs
Warranty	1 year
Certifications	CE, RoHS
Electrical Data	
Input voltage	DC 12V/DC24V
Insulation class	Class III
Cable	1PC rubber cable 1M H05RN-F 2x1mm square
Driver	Low voltage constant current output, excluding the transformer
Construction Data	
IP rating	IP68 Waterproof
IK rating	IK06
Housing	Stainless steel 316
Protection finishing	Passivated
Trim	Stainless steel 316
Glass	Step tempered Glass, T=6mm.
Loading capacity	320 kgs
Cable Gland	PG7 IP68
Gasket	O-ring PMQ silicone seal
Accessories	
Mounting Sleeve	Anti-corrosion black PVC, with screws fixed
Packaging	
Inner box size	88*88*105 mm
Carton size	46*28.5*24 cm (30PCS / carton)



CE RoHS COMPLIANT IP68 IK09

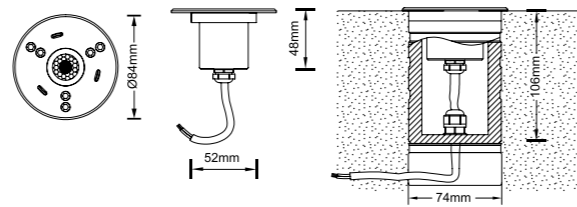
SSS 316 1 Year Warranty

Use only in permanent immersion in water as to avoid damaging to LED!

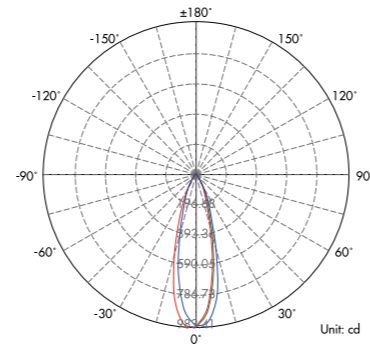
RGB

Parameter	
General Data	
Item No.	UL-3006-0500-A / UL-3006-0700-A
Power	5 Watts (7 watts as options)
LED type	1 PC 5W CREE COB LED (7W COB LED as options)
Luminous flux	300~330 lm
CCT	2700K, 3000K, 4000K, 6000K, Blue
CRI	80+
Beam angle	25°, 40°
Dimension	84 x 48 (mm) Diameter x Height
Cut out	74 mm
Net weight	0.89 kgs
Warranty	1 year
Certifications	CE, RoHS
Electrical Data	
Input voltage	DC 12V
Insulation class	Class III
Cable	1PC rubber cable 1M H05RN-F 2x1mm square
Driver	Low voltage constant current output, excluding the transformer
Construction Data	
IP rating	IP68 Waterproof
IK rating	IK09
Housing	Stainless steel 316
Protection finishing	/
Trim	Stainless steel 316
Glass	Step tempered Glass. T=10mm.
Loading capacity	2000 kgs
Cable Gland	PG7 IP68, glue
Gasket	O-ring PMQ silicone seal
Accessories	
Mounting Sleeve	High quality anti-corrosion Nylon PA66, CNC machined
Packaging	
Inner box size	92*92*125 mm
Carton size	29.5*20*14 cm (6PCS / carton)

Dimension



Light Distribution Curve (3000K, 25°)



Lux distance Curve (3000K, 25°)

	Illuminance at a Distance	
	Center Beam LUX	Beam Width V H
2m	245.09 LUX	1.0m 1.0m
4m	61.27 LUX	2.0m 2.0m
6m	27.23 LUX	3.1m 3.0m
8m	15.32 LUX	4.1m 4.1m
10m	9.80 LUX	5.1m 5.1m
12m	6.81 LUX	6.1m 6.1m

Vert.Spread:28.7 Horiz.Spread:28.5

Illumination Picture (25°)



CE RoHS COMPLIANT IP68 IK09

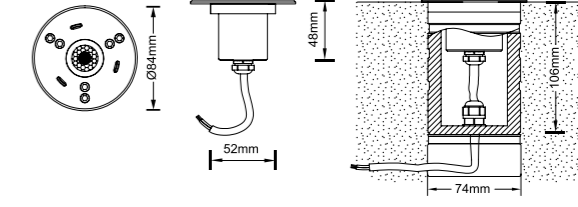
SSS 316 1 Year Warranty

Use only in permanent immersion in water as to avoid damaging to LED!

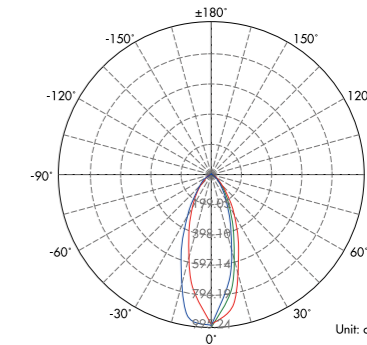
RGB

Parameter	
General Data	
Item No.	UL-3006-0900(RGB)-A
Power	9 Watts
LED type	1 PC 9W RGB 5050 SMD LED
Luminous flux	540 lm (All LEDs on)
CCT	RGB
CRI	70+
Beam angle	25°, 40°
Dimension	84 x 48 (mm) Diameter x Height
Cut out	74 mm
Net weight	0.96 kgs
Warranty	1 year
Certifications	CE, RoHS
Electrical Data	
Input voltage	DC 12V
Insulation class	Class III
Cable	1PC rubber cable 1.5M H05RN-F 4x0.75mm square
Driver	Low voltage constant current output, excluding the transformer
Construction Data	
IP rating	IP68 Waterproof
IK rating	IK09
Housing	Stainless steel 316
Protection finishing	/
Trim	Stainless steel 316
Glass	Step tempered Glass. T=10mm.
Loading capacity	2000 kgs
Cable Gland	PG9 IP68, glue
Gasket	O-ring PMQ silicone seal
Accessories	
Mounting Sleeve	High quality anti-corrosion Nylon PA66, CNC machined
Packaging	
Inner box size	92*92*125 mm
Carton size	29.5*20*14 cm (6PCS / carton)

Dimension



Light Distribution Curve (RGB, 25°)

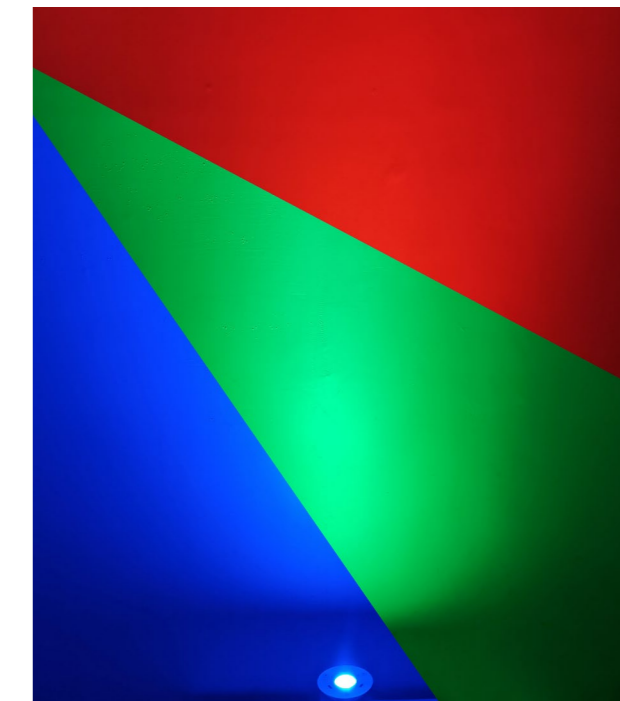


Lux distance Curve (RGB, 25°)

	Illuminance at a Distance	
	Center Beam LUX	Beam Width V H
2m	243.61 LUX	1.4m 1.4m
4m	60.90 LUX	2.8m 2.8m
6m	27.07 LUX	4.2m 4.3m
8m	15.23 LUX	5.6m 5.7m
10m	9.74 LUX	7.0m 7.1m
12m	6.77 LUX	8.4m 8.5m

Vert.Spread:38.8 Horiz.Spread:39.2

Illumination Picture (25°)





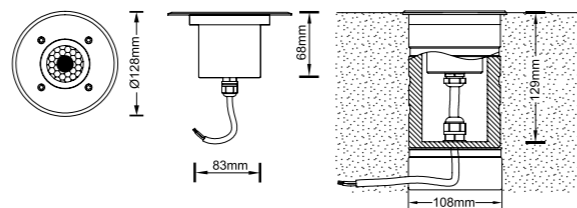


CE RoHS COMPLIANT IP68 IK09
SSS 316 1 Year Warranty

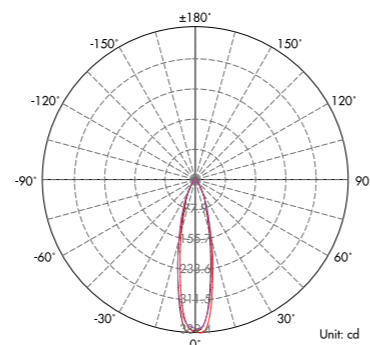
Use only in permanent immersion in water as to avoid damaging to LED!

Parameter	
General Data	
Item No.	UL-6003-1200-A/UL-6003-1800-A
Power	12 Watts (18 watts or 22 watts as options)
LED type	1 PC 12W CREE COB LED
Luminous flux	800-900 lm
CCT	2700K, 3000K, 4000K, 6000K
CRI	80+
Beam angle	10°, 23°, 36°
Dimension	128 x 68 (mm) Diameter x Height
Cut out	108 mm
Net weight	2.25 kgs
Warranty	1 year
Certifications	CE, RoHS
Electrical Data	
Input voltage	DC 12V
Insulation class	Class III
Cable	1PC rubber cable 1M H05RN-F 2x1mm square
Driver	Low voltage constant current output, excluding the transformer
Construction Data	
IP rating	IP68 Waterproof
IK rating	IK09
Housing	Stainless steel 316
Protection finishing	/
Trim	Stainless steel 316
Glass	Step tempered Glass, T=10mm.
Loading capacity	2000 kgs
Cable Gland	PG7 IP68, glue
Gasket	O-ring PMQ silicone seal
Accessories	
Mounting Sleeve	High quality anti-corrosion Nylon PA66, CNC machined
Packaging	
Inner box size	140*140*175mm
Carton size	34*31*40 cm (8PCS / carton)

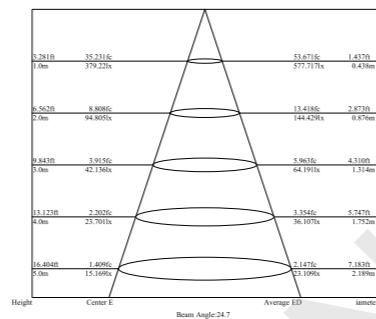
Dimension



Light Distribution Curve (3000K, 36°)



Lux distance Curve (3000K, 36°)



Illumination Picture (36°)



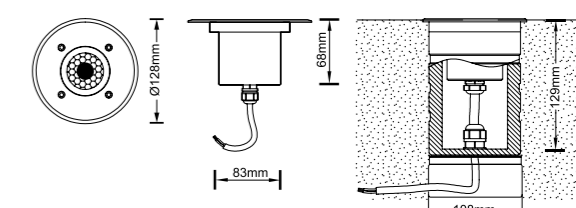
CE RoHS COMPLIANT IP68 IK09
SSS 316 1 Year Warranty

RGB / RGBW

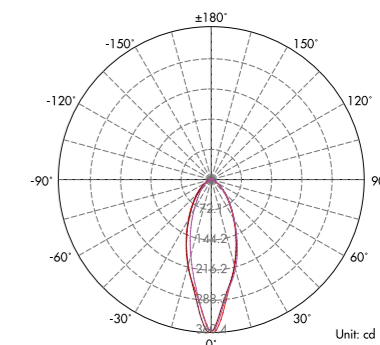
Use only in permanent immersion in water as to avoid damaging to LED!

Parameter	
General Data	
Item No.	UL-6003-1800 (RGB)/A / UL-6003-1800-RGBW-A
Power	18 Watts
LED type	1PC 18W OSRAM RGB / RGBW LED
Luminous flux	1080lm (All LEDs on)
CCT	RGB / RGBW (W:3000K, 4000K, 6000K optional)
CRI	70+
Beam angle	30°
Dimension	128 x 68 (mm) Diameter x Height
Cut out	108 mm
Net weight	2.32 kgs
Warranty	1 year
Certifications	CE, RoHS
Electrical Data	
Input voltage	DC 12V
Insulation class	Class III
Cable	1PC rubber cable 1.5M H05RN-F 4 or 5x0.75mm square
Driver	Low voltage constant current output, excluding the transformer
Construction Data	
IP rating	IP68 Waterproof
IK rating	IK09
Housing	Stainless steel 316
Protection finishing	/
Trim	Stainless steel 316
Glass	Step tempered Glass, T=10mm.
Loading capacity	2000 kgs
Cable Gland	PG9 IP68, glue
Gasket	O-ring PMQ silicone seal
Accessories	
Mounting Sleeve	High quality anti-corrosion Nylon PA66, CNC machined
Packaging	
Inner box size	140*140*175mm
Carton size	34*31*40mm (8PCS / carton)

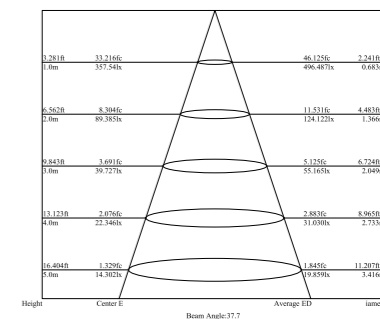
Dimension



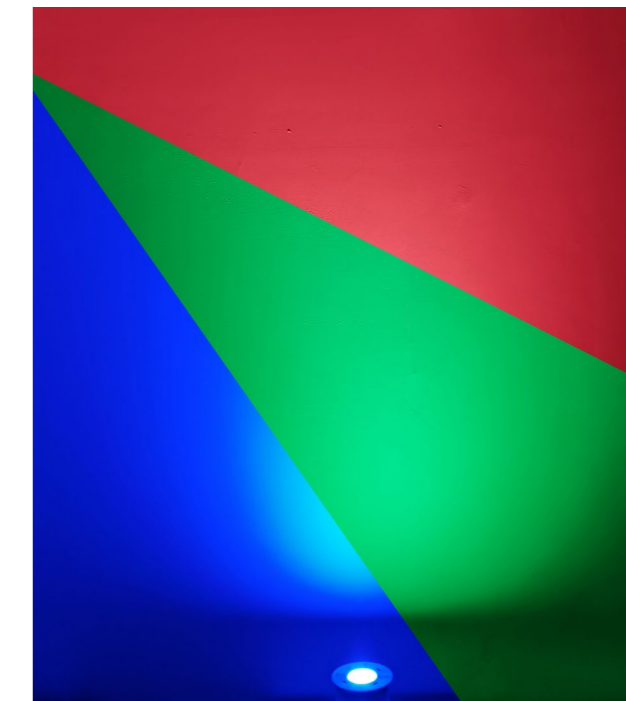
Light Distribution Curve (RGB, 30°)



Lux distance Curve (RGB, 30°)



Illumination Picture (30°)





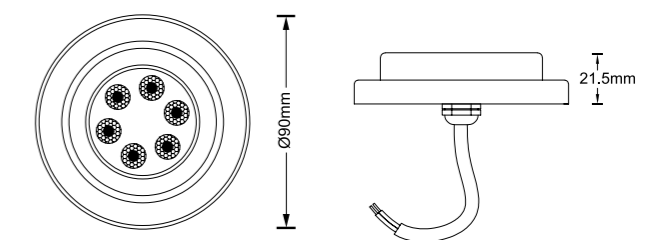
CE RoHS COMPLIANT IP68 IK07

SSS 316 1 Year Warranty

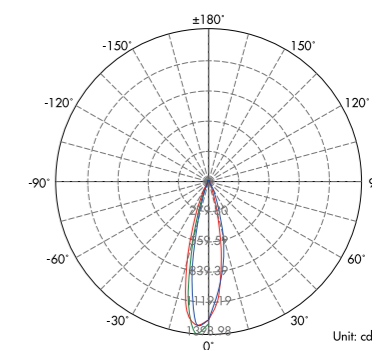
Use only in permanent immersion in water as to avoid damaging to LED!

Parameter	
General Data	
Item No.	UL-6004-0600-A
Power	6 Watts
LED type	6 PCS 1W OSRAM LED
Luminous flux	420-450 lm
CCT	2700K, 3000K, 4000K, 6000K
CRI	80+
Beam angle	15°, 25°, 40°
Dimension	90x21.5 (mm) Diameter x Height
Cut out	/
Net weight	0.54kgs
Warranty	1 year
Certifications	CE, RoHS
Electrical Data	
Input voltage	DC12V
Insulation class	Class III
Cable	1 x cable 1M H05RN-F 2x1 mm square to open wires
Driver	Low voltage constant current output, excluding the transformer
Construction Data	
IP rating	IP68 Waterproof
IK rating	IK07
Housing	Stainless steel 316
Protection finishing	/
Trim	Stainless steel 316
Glass	Step tempered Glass. T=5mm.
Loading capacity	610 kgs
Cable Gland	PG7 IP68
Gasket	O-ring PMQ silicone seal
Accessories	
Mounting Sleeve	3 PCS SS304 Screws with mounting parts.
Packaging	
Inner box size	95*95*55 mm
Carton size	30*21*11.5 cm (12PCS / carton)

Dimension



Light Distribution Curve (3000K, 25°)

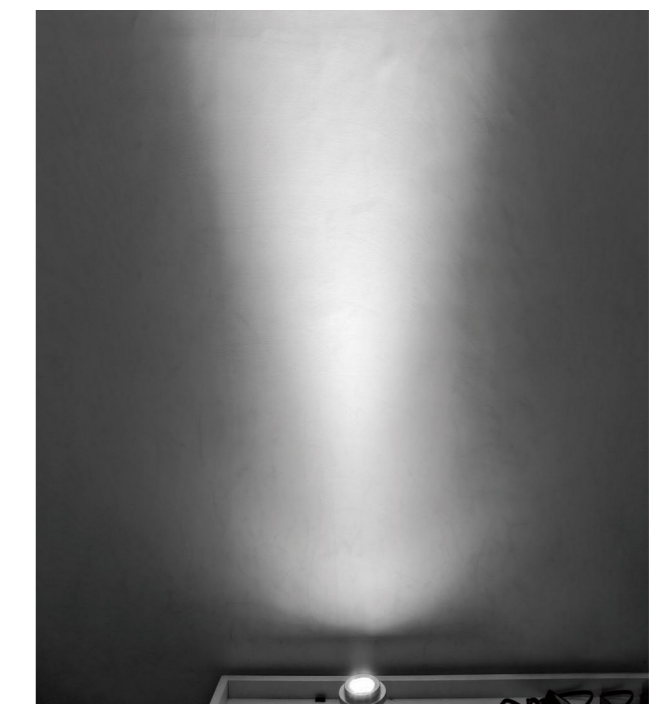


Lux distance Curve (3000K, 25°)

	Illuminance at a Distance	
	Center Beam LUX	Beam Width V H
2m	318.18 LUX	0.9m 0.9m
4m	79.55 LUX	1.8m 1.8m
6m	35.35 LUX	2.6m 2.6m
8m	19.89 LUX	3.5m 3.5m
10m	12.73 LUX	4.4m 4.4m
12m	8.84 LUX	5.3m 5.3m

Vert.Spread:24.7 Horiz.Spread:24.7

Illumination Picture (25°)





CE RoHS COMPLIANT IP68 IK07

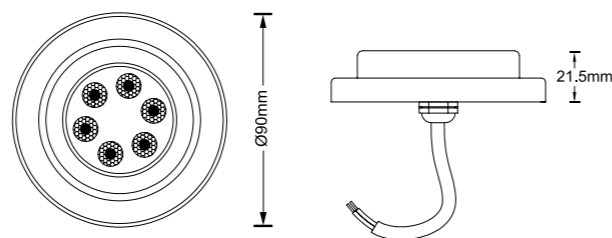
SSS 316 Passivated 1 Year Warranty

RGB

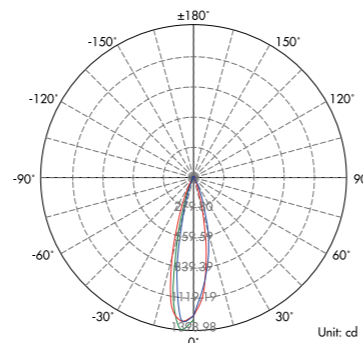
Use only in permanent immersion in water as to avoid damaging to LED!

Parameter	
General Data	
Item No.	UL-6004-0600-RGB-A
Power	6 Watts
LED type	6PCS 1W 3in1 RGB LED
Luminous flux	/
CCT	RGB
CRI	/
Beam angle	15°, 25°, 40°
Dimension	90x 21 (mm) Diameter x Height
Cut out	/
Net weight	0.54kgs
Warranty	1 year
Certifications	CE, RoHS
Electrical Data	
Input voltage	DC 12V
Insulation class	Class III
Cable	1 x cable 1M H05RN-F 2x1mm square to open wires
Driver	Low voltage constant current output, excluding the transformer
Construction Data	
IP rating	IP68 Waterproof
IK rating	IK07
Housing	Stainless steel 316
Protection finishing	/
Trim	Stainless steel 316
Glass	Step tempered Glass, T=5mm.
Loading capacity	610 kgs
Cable Gland	PG7 IP68
Gasket	O-ring PMQ silicone seal
Accessories	
Mounting Sleeve	3 PCS SS304 Screws with mounting parts for surface mounting.
Packaging	
Inner box size	95*95*55 mm
Carton size	30*21*11.5 cm (12PCS / carton)

Dimension



Light Distribution Curve (RGB)

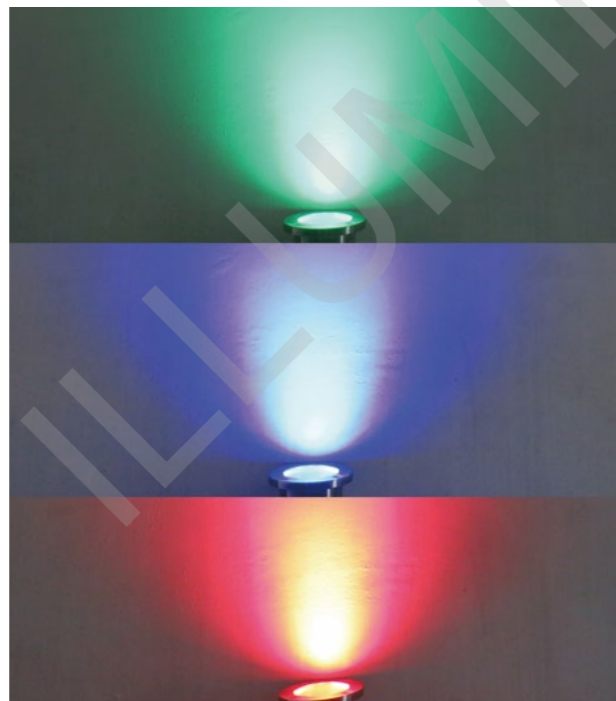


Lux distance Curve (RGB)

Distance (m)	Illuminance at a Distance	
	Center Beam LUX	Beam Width V x H
2m	318.18 LUX	0.9m x 0.9m
4m	79.55 LUX	1.8m x 1.8m
6m	35.35 LUX	2.6m x 2.6m
8m	19.89 LUX	3.5m x 3.5m
10m	12.73 LUX	4.4m x 4.4m
12m	8.84 LUX	5.3m x 5.3m

Vert. Spread: 24.7 Horiz. Spread: 24.7

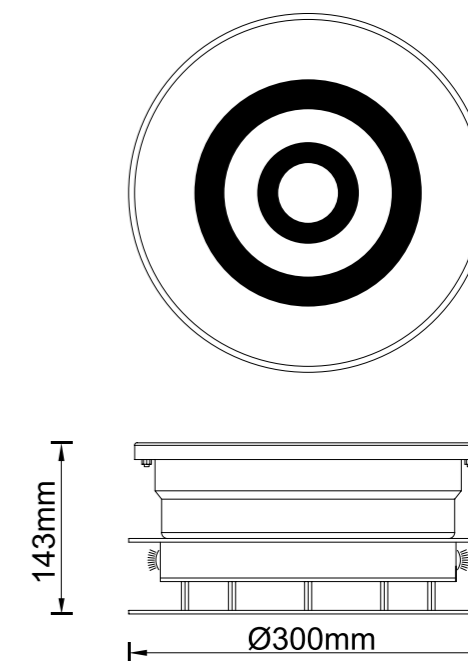
Illumination Picture (RGB)



CE RoHS COMPLIANT IP68 IK06

SSS 304 1 Year Warranty

Dimension



Illumination Picture



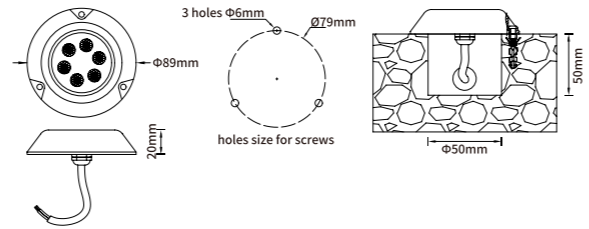
Parameter	
General Data	
Item No.	SL-3601-(RGB)
Power	Top: 24W +10% all LEDs on Side: 12W +10% all LEDs on
LED type	Top: 60PCS+24PCS 3535 RGB Side: 72PCS 5050 RGB
Luminous flux	/
CCT	RGB
CRI	/
Beam angle	Top: 100° Side: 360°
Dimension	Ø300x143mm (mm) Diameter x length
Cut out	/ mm
Net weight	8.7 kgs
Warranty	1 year
Certifications	CE, RoHS
Electrical Data	
Input voltage	DC24V
Insulation class	Class III
Cable	Power cable: 1PC in +1PC out 1.5M 2*2.5mm ² rubber cable Signal cable: 1PC in +1PC out 1.5M 4*0.75mm ² rubber cable
Driver	builtin DMX 512 decoder
Construction Data	
IP rating	IP68 Waterproof
IK rating	IK06
Housing	stainless steel 304
Protection finishing	Powder coated painting in dark grey
Trim	stainless steel 304
Glass	Tempered Glass
Loading capacity	/
Cable Gland	PG gland
Accessories	
Spike	SSS 304 bracket for surface mounted
Packaging	
Inner box size	/
Carton size	35*35*20.5 cm (1 PC/carton)



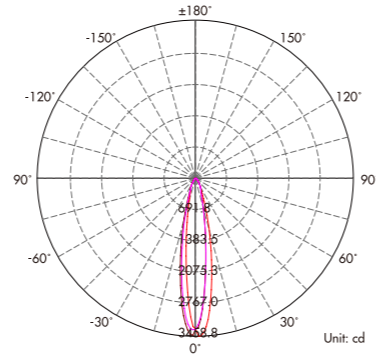
Marine SF



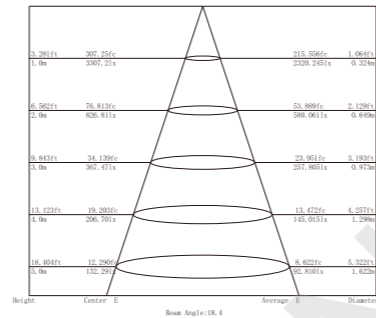
Dimension



Light Distribution Curve (3000K, 15°)



Lux distance Curve (3000K, 15°)



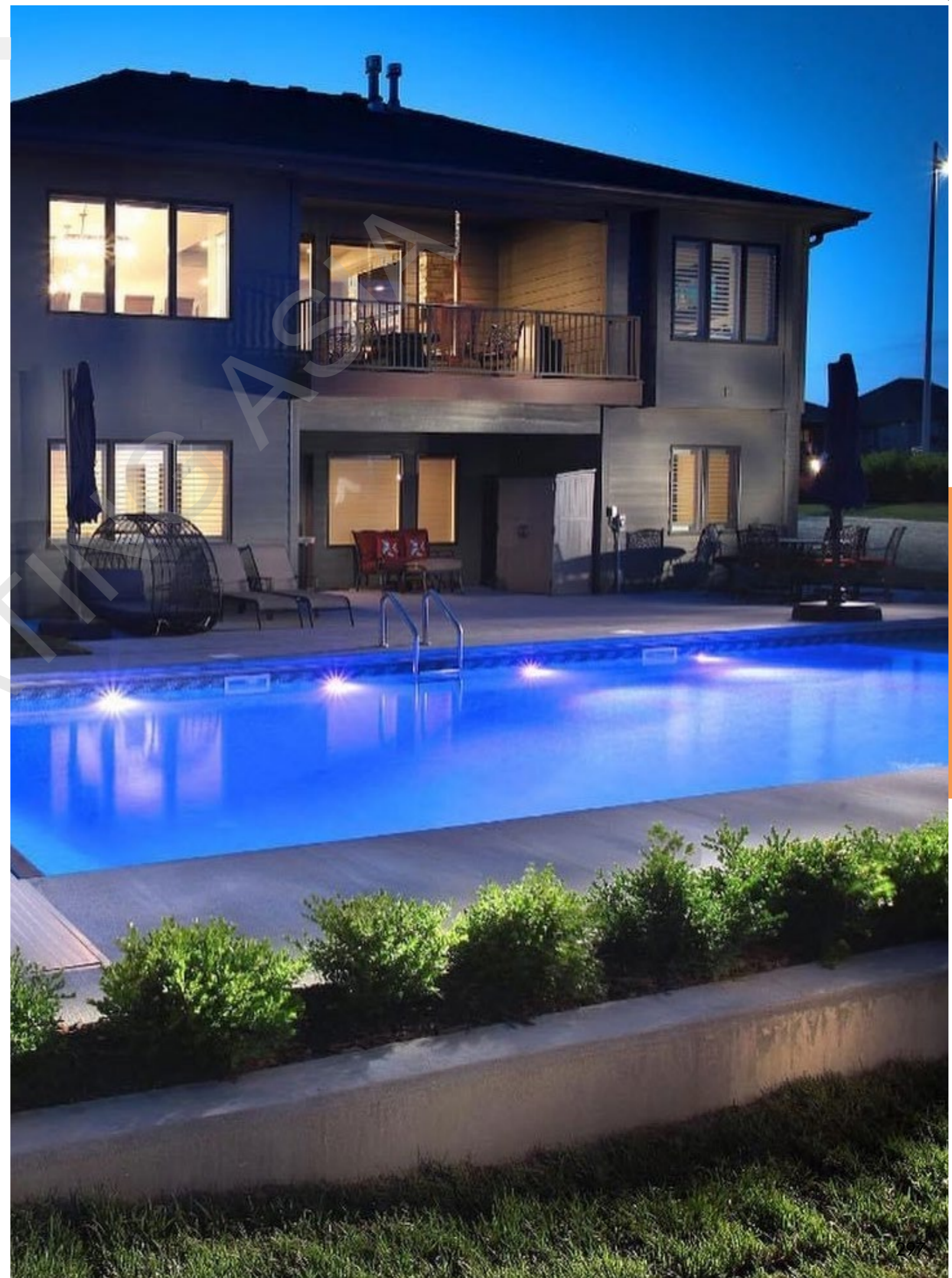
Illumination Picture (15°)

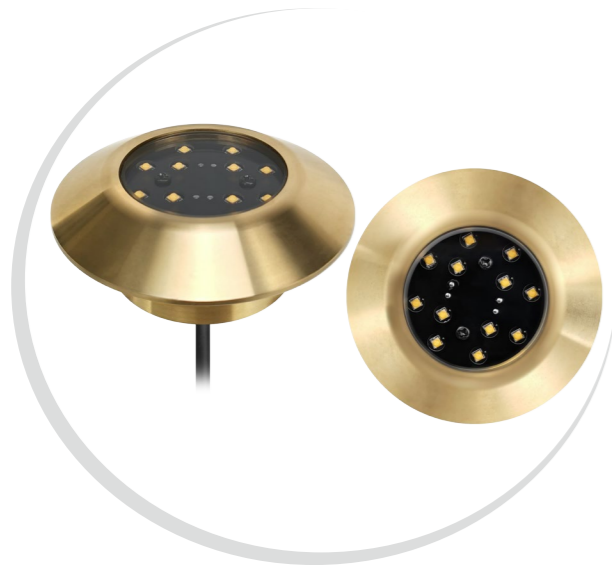


CE RoHS COMPLIANT IP68 IK07
Copper 1 Year Warranty

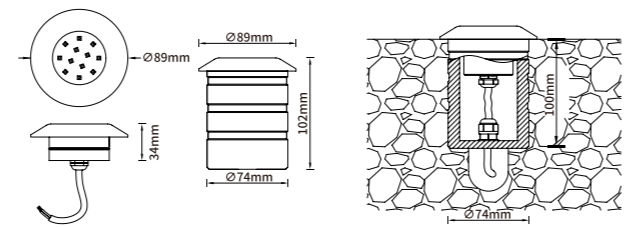
Parameter

General Data	
Item No.	SL-6005-1500-A
Power	1.5W±10%
LED type	6 PCS OSRAM 3030 LED
Luminous flux	700 lm +10%
CCT	2700K\3000K\4000K\6000K
CRI	80+
Beam angle	15°,24°,40°
Dimension	Ø89x20 (mm) Diameter x length
Cut out	Surface mounted, 3PCS screw holes 6mm
Net weight	0.6 kgs
Warranty	1 year
Certifications	CE, RoHS
Electrical Data	
Input voltage	DC 12V-DC24V
Insulation class	Class III
Cable	2M HOSRN-F 2x1.0 mm square
Driver	constant low voltage input, constant current output for LEDs
Construction Data	
IP rating	IP68 Waterproof
IK rating	IK07
Housing	Copper
Protection finishing	/
Trim	Copper
Glass	Tempered Glass
Loading capacity	/
Cable Gland	PG gland
Gasket	silicone ring + silicone glue seal
Accessories	
Screw	Screws for surface mounted
Packaging	
Inner box size	100*100*100mm
Carton size	42*32*22 cm (24PCS/carton)

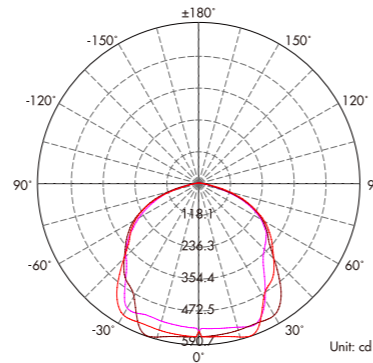




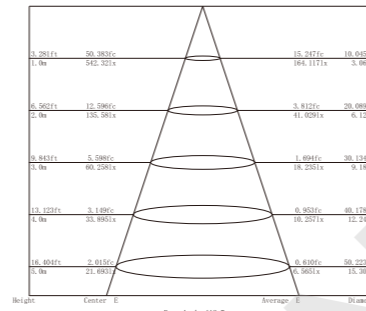
Dimension



Light Distribution Curve (3000K, 110°)



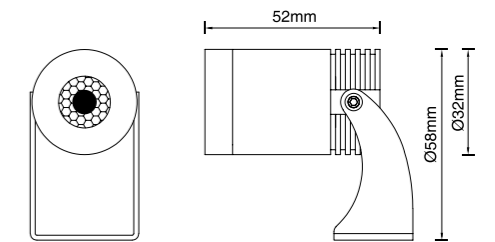
Lux distance Curve (3000K, 110°)



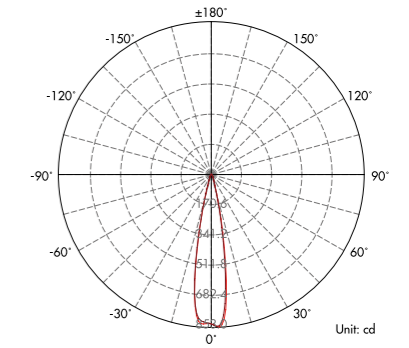
Illumination Picture (110°)



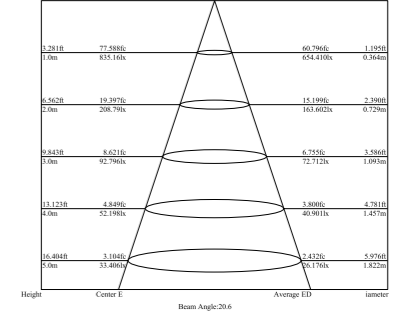
Dimension



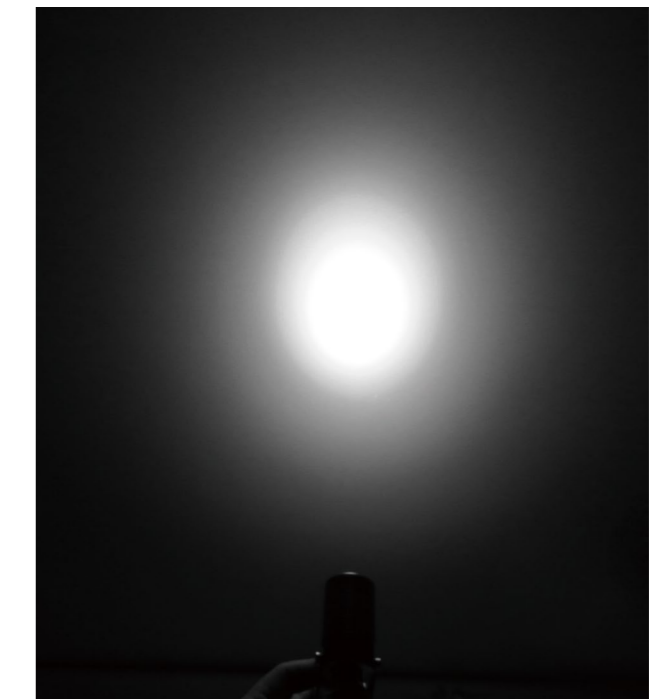
Light Distribution Curve (3000K, 25°)



Lux distance Curve (3000K, 25°)



Illumination Picture (25°)



CE RoHS COMPLIANT IP68 IK07
Copper 1 Year Warranty

CE RoHS COMPLIANT IP68 IK04
SSS 316 1 Year Warranty

Use only in permanent immersion in water as to avoid damaging to LED!

Parameter	
General Data	
Item No.	SL-1201-2400-C
Power	24V±10%
LED type	12 PCS OSRAM 3030 LED
Luminous flux	1600 lm +10%
CCT	2700K\3000K\4000K\4500K\5700K\6500K
CRI	80+
Beam angle	110°
Dimension	Ø89x34 (mm) Diameter x length
Cut out	Ø74 (mm) Diameter
Net weight	1 kgs
Warranty	1 year
Certifications	CE, RoHS
Electrical Data	
Input voltage	DC24V
Insulation class	Class III
Cable	2M H05RN-F 2x1.0 mm square
Driver	constant low voltage input, constant current output for LEDs
Construction Data	
IP rating	IP68 Waterproof
IK rating	IK07
Housing	Copper
Protection finishing	/
Trim	Copper
Glass	Tempered Glass
Loading capacity	/
Cable Gland	PG gland
Accessories	
Mounting box	Nylon mounting box
Packaging	
Inner box size	160*130*130 mm
Carton size	41.5*34*28 cm (12 PCS/carton)

Parameter	
General Data	
Item No.	SL-1004-0300-A
Power	3 Watts
LED type	1PC CREE XPE LED
Luminous flux	110~130 lm
CCT	2700K, 3000K, 4000K, 6000K
CRI	80+
Beam angle	10°, 15°, 30°, 45°, 60°
Dimension	Ø32x52 (mm) Diameter x length
Cut out	/
Net weight	0.3 kgs
Warranty	1 year
Certifications	CE, RoHS
Electrical Data	
Input voltage	DC 12V
Insulation class	Class III
Cable	1PC rubber cable 1M H05RN-F 2x1mm square
Driver	Low voltage constant current driver without transformer
Construction Data	
IP rating	IP68 Waterproof
IK rating	IK04
Housing	Stainless steel 316
Protection finishing	Stainless steel 316
Trim	Stainless steel 316
Glass	Tempered Glass, T=2mm.
Loading capacity	220 kgs
Cable Gland	PG gland
Gasket	O-ring PMQ silicone seal
Accessories	
Spike	PVC spike as optional
Round base	With SS304 round base as optional
Packaging	
Inner box size	120*100*50 mm
Carton size	26.5*22.5*27.5 cm (20 PCS / carton)



CE RoHS COMPLIANT IP68 IK04

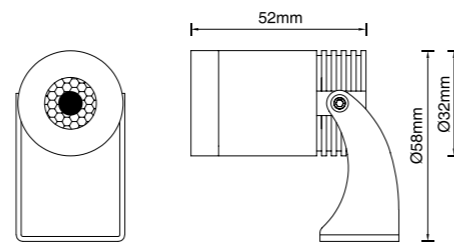
SSS 316 1 Year Warranty

RGB / RGBW

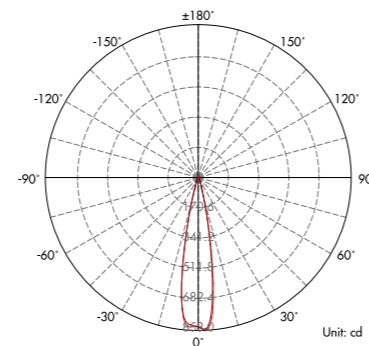
Use only in permanent immersion in water as to avoid damaging to LED!

Parameter	
General Data	
Item No.	SL-1004-0300-RGBW-A
Power	3 Watts
LED type	1 PC 3W RGBW LED
Luminous flux	/
CCT	RGBW3000K or RGBW4000K, or RGBW6000K
CRI	/
Beam angle	30°
Dimension	Ø32x52 (mm) Diameter x length
Cut out	/
Net weight	0.35 kgs
Warranty	1 year
Certifications	CE, RoHS
Electrical Data	
Input voltage	DC 12V
Insulation class	Class III
Cable	1PC rubber cable 1M H05RN-F 5x0.5mm square
Driver	Low voltage input, constant current output, excluding the transformer
Construction Data	
IP rating	IP68 Waterproof
IK rating	IK04
Housing	Stainless steel 316
Protection finishing	Stainless steel 316
Trim	Stainless steel 316
Glass	Tempered Glass. T=2mm
Loading capacity	220 kgs
Cable Gland	PG gland
Gasket	O-ring PMQ silicone seal
Accessories	
Spike	PVC spike as optional
Round base	With SS304 round base as optional
Packaging	
Inner box size	120*100*50 mm
Carton size	26.5*22.5*27.5 cm (20 PCS / carton)

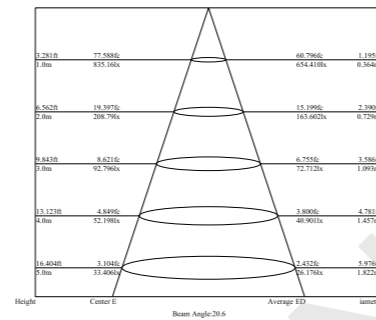
Dimension



Light Distribution Curve (3000K, 30°)



Lux distance Curve (3000K, 30°)



Illumination Picture (30°)



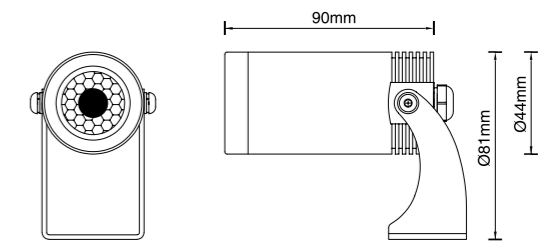
CE RoHS COMPLIANT IP68 IK04

SSS 316 1 Year Warranty

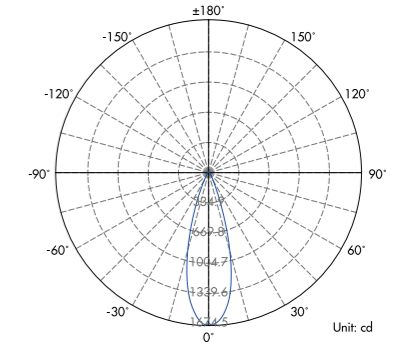
Use only in permanent immersion in water as to avoid damaging to LED!

Parameter	
General Data	
Item No.	SL-1010-0800-A
Power	8 Watts
LED type	1 PC 8W CREE COB LED
Luminous flux	500~550 lm
CCT	2700K, 3000K, 4000K, 6000K
CRI	80+
Beam angle	15°, 24°, 36°, 60°
Dimension	Ø44 x 90 (mm) Diameter x length
Cut out	/
Net weight	0.7 kgs
Warranty	1 year
Certifications	CE, RoHS
Electrical Data	
Input voltage	DC 12V
Insulation class	Class III
Cable	1PC rubber cable 1M H05RN-F 2x1mm square
Driver	Low voltage input, constant current output, excluding the transformer
Construction Data	
IP rating	IP68 Waterproof
IK rating	IK04
Housing	Stainless steel 316
Protection finishing	Stainless steel 316
Trim	Stainless steel 316
Glass	Tempered Glass. T=2mm.
Loading capacity	220 kgs
Cable Gland	PG gland
Gasket	O-ring PMQ silicone seal
Accessories	
Spike	PVC spike as optional
Round base	With SS304 round base as optional
Packaging	
Inner box size	116*95*48 mm
Carton size	49*25*16 cm (30 PCS / carton)

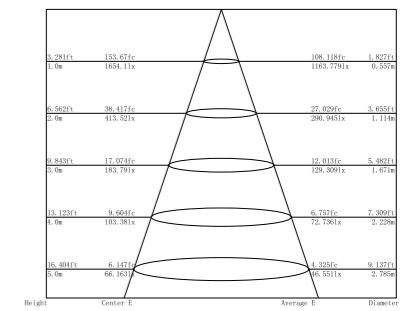
Dimension



Light Distribution Curve (3000K, 36°)



Lux distance Curve (3000K, 36°)



Illumination Picture (36°)





CE RoHS COMPLIANT IP68 IK04

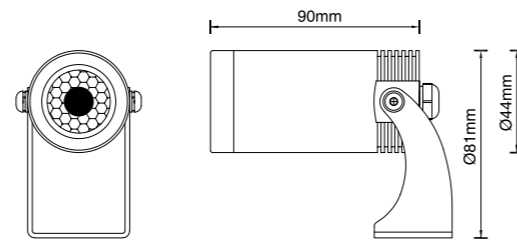
SSS 316 1 Year Warranty

RGB / RGBW

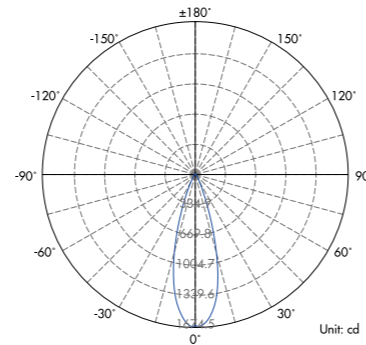
Use only in permanent immersion in water as to avoid damaging to LED!

Parameter	
General Data	
Item No.	SL-10100800-RGBWA
Power	8 Watts
LED type	1 PC 8W RGBW LED
Luminous flux	/
CCT	RGBW3000K or RGBW4000K or RGBW6000K
CRI	/
Beam angle	15°, 24°, 36°, 60°
Dimension	Ø44 x 90 (mm) Diameter x length
Cut out	/
Net weight	0.75 kgs
Warranty	1 year
Certifications	CE, RoHS
Electrical Data	
Input voltage	DC 12V
Insulation class	Class III
Cable	1PC rubber cable 1M H05RN-F 5x0.5mm square
Driver	Low voltage input, constant current output, excluding the transformer
Construction Data	
IP rating	IP68 Waterproof
IK rating	IK04
Housing	Stainless steel 316
Protection finishing	Stainless steel 316
Trim	Stainless steel 316
Glass	Tempered Glass, T=2mm.
Loading capacity	220 kgs
Cable Gland	PG gland
Gasket	O-ring PMQ silicone seal
Accessories	
Spike	PVC spike as optional
Round base	With SS304 round base as optional
Packaging	
Inner box size	116*95*48 mm
Carton size	49*25*16 cm (30 PCS / carton)

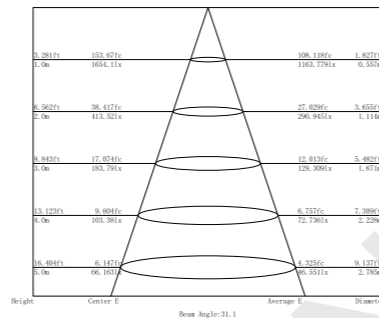
Dimension



Light Distribution Curve (3000K, 36°)



Lux distance Curve (3000K, 36°)



Illumination Picture (36°)



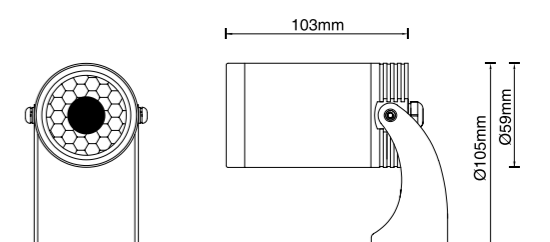
CE RoHS COMPLIANT IP68 IK04

SSS 316 1 Year Warranty

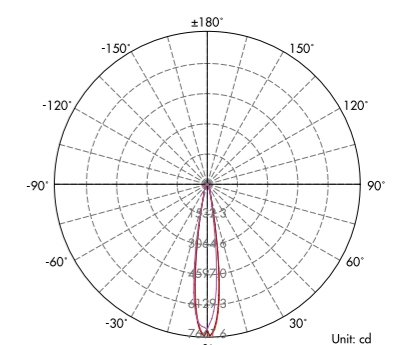
Use only in permanent immersion in water as to avoid damaging to LED!

Parameter	
General Data	
Item No.	SL-15W-COB-1500A
Power	15 Watts
LED type	1 PC 15W CREE COB LED
Luminous flux	1000-1050 lm
CCT	2700K, 3000K, 4000K, 6000K
CRI	80+
Beam angle	10°, 23°, 36°
Dimension	Ø59 x 103 (mm) Diameter x length
Cut out	/
Net weight	1.1 kgs
Warranty	1 year
Certifications	CE, RoHS
Electrical Data	
Input voltage	DC 12V
Insulation class	Class III
Cable	1PC rubber cable 1M H05RN-F 2x1mm square
Driver	Low voltage input, constant current output, excluding the transformer
Construction Data	
IP rating	IP68 Waterproof
IK rating	IK04
Housing	Stainless steel 316
Protection finishing	Stainless steel 316
Trim	Stainless steel 316
Glass	Tempered Glass, T=2mm.
Loading capacity	220 kgs
Cable Gland	PG gland
Gasket	O-ring PMQ silicone seal
Accessories	
Spike	PVC spike as optional
Round base	With SS304 round base as optional
Packaging	
Inner box size	160*120*80 mm
Carton size	34.5*26.5*26.5 cm (12 PCS / carton)

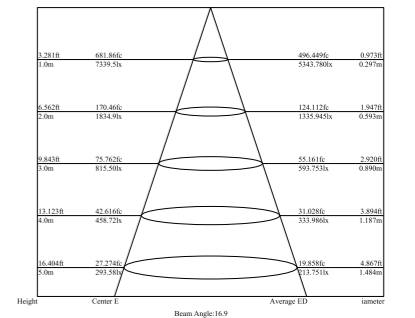
Dimension



Light Distribution Curve (3000K, 10°)



Lux distance Curve (3000K, 10°)



Illumination Picture (10°)





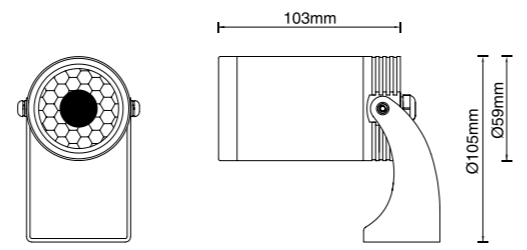
CE RoHS COMPLIANT IP68 IK04
SSS 316 1 Year Warranty

RGB / RGBW

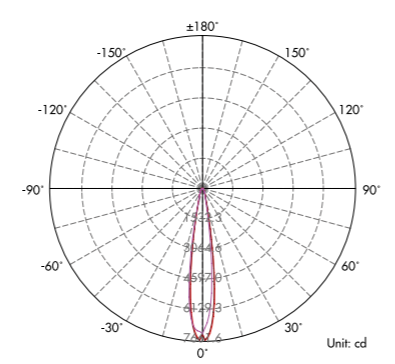
Use only in permanent immersion in water as to avoid damaging to LED!

Parameter	
General Data	
Item No.	SL-15W-COB-1500-RGBW-A
Power	1.5 Watts
LED type	1 PC 15W RGBW LED
Luminous flux	/
CCT	RGBW3000K or RGBW4000K or RGBW6000K
CRI	/
Beam angle	10°, 23°, 36°
Dimension	Ø59 x 103 (mm) Diameter x length
Cut out	/
Net weight	1.15 kgs
Warranty	1 year
Certifications	CE, RoHS
Electrical Data	
Input voltage	DC 12V
Insulation class	Class III
Cable	1PC rubber cable 1M H05RN-F 5x0.5mm square
Driver	Low voltage input, constant current output, excluding the transformer
Construction Data	
IP rating	IP68 Waterproof
IK rating	IK04
Housing	Stainless steel 316
Protection finishing	Stainless steel 316
Trim	Stainless steel 316
Glass	Tempered Glass, T=2mm.
Loading capacity	220 kgs
Cable Gland	PG gland
Gasket	O-ring PMQ silicone seal
Accessories	
Spike	PVC spike as optional
Round base	With SS304 round base as optional
Packaging	
Inner box size	160*120*80 mm
Carton size	34.5*26.5*26.5 cm (12 PCS / carton)

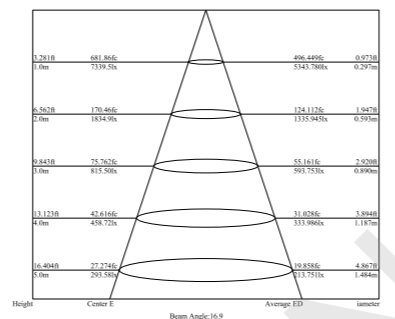
Dimension



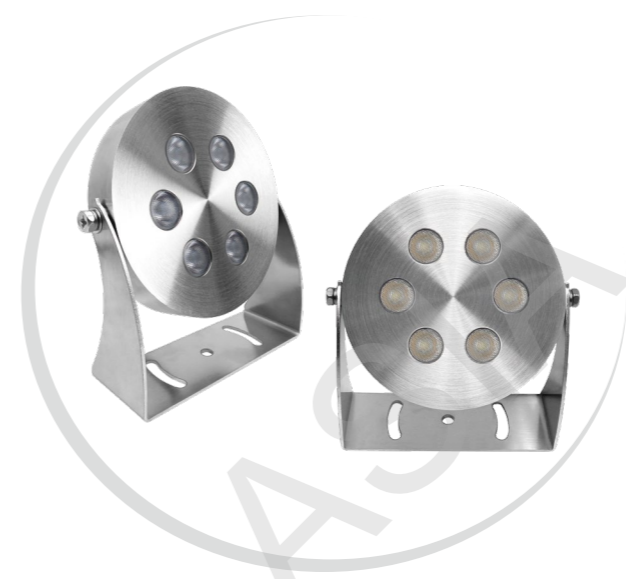
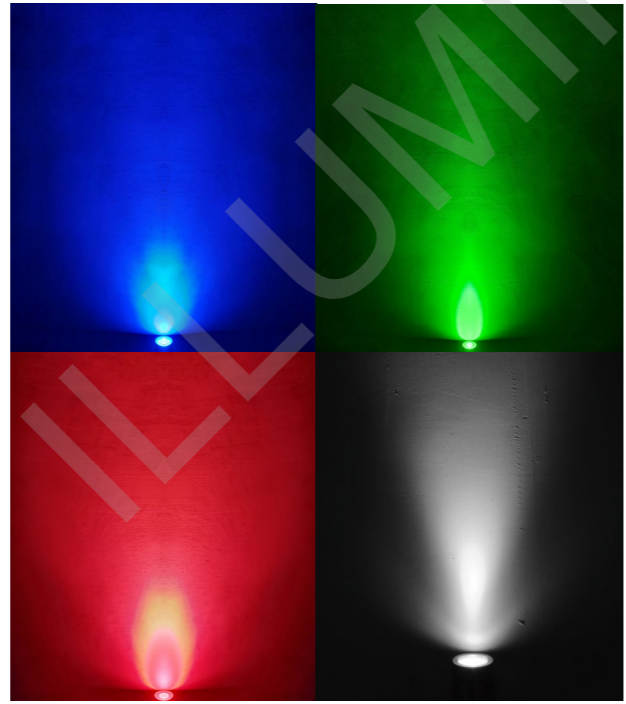
Light Distribution Curve (3000K, 10°)



Lux distance Curve (3000K, 10°)



Illumination Picture (10°)

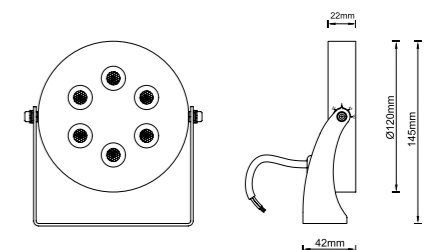


CE RoHS COMPLIANT IP68 IK09
SSS 316 1 Year Warranty

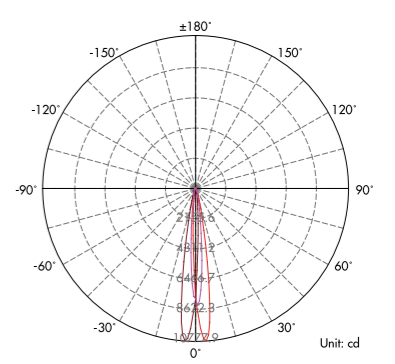
Use only in permanent immersion in water as to avoid damaging to LED!

Parameter	
General Data	
Item No.	SL-6001-1200-B
Power	12 Watts +10%
LED type	6PCS 2W CREE XPE LED
Luminous flux	720 lm+10%
CCT	2700K, 3000K, 4000K, 6000K
CRI	80+
Beam angle	6°, 8°, 10°, 17°, 23°, 28°, 43°
Dimension	145*120*47 (mm) Height x Diameter x Thickness
Cut out	/
Net weight	1 kgs
Warranty	1 year
Certifications	CE, RoHS
Electrical Data	
Input voltage	DC 12V
Insulation class	Class III
Cable	1PC rubber cable 1M H05RN-F 2x1mm square
Driver	Low voltage input, constant current output, excluding the transformer
Construction Data	
IP rating	IP68 Waterproof
IK rating	IK09
Housing	Stainless steel 316
Protection finishing	Stainless steel 316
Trim	Stainless steel 316
Glass	Tempered Glass, T=2mm.
Loading capacity	700 kgs
Cable Gland	PG gland
Gasket	O-ring PMQ silicone seal
Accessories	
Spike	PVC spike as optional
Packaging	
Inner box size	mm
Carton size	44.5x33.5x14.5 cm (12 PCS / carton)

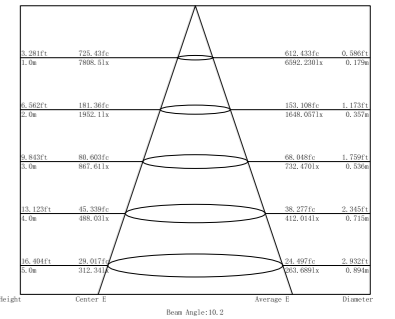
Dimension



Light Distribution Curve (3000K, 10°)



Lux distance Curve (3000K, 10°)

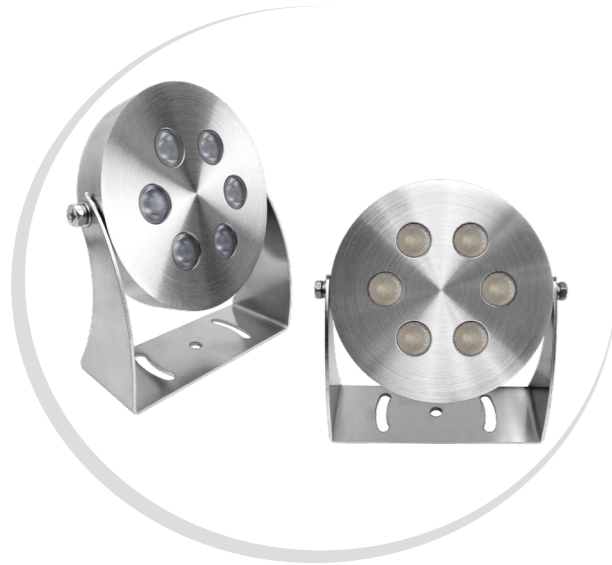


Illumination Picture (10°)



UNDERWATER LIGHTS SERIES

UNDERWATER LIGHTS SERIES



CE RoHS COMPLIANT IP68 IK09

SSS 316 1 Years Warranty

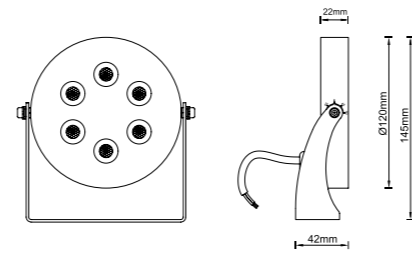
RGBW DMX512 Control

Use only in permanent immersion in water as to avoid damaging to LED!

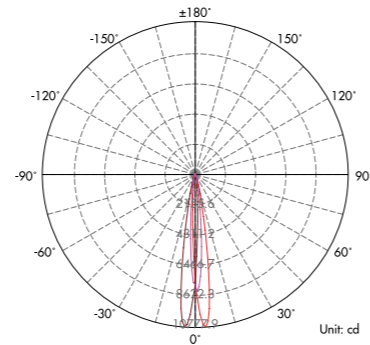
Parameter

General Data	
Item No.	SI-6001-1200(RGBW)B
Power	12 Watts +10%
LED type	6 PCS 2V RGBW 3030 LED
Luminous flux	/
CCT	RGBW3000K or RGBW4000K or RGBW5500K
CRI	/
Beam angle	6°, 8°, 10°, 17°, 23°, 28°, 43°
Dimension	145*120*47 (mm) Height x Diameter x Thickness
Cut out	/
Net weight	1.05 kgs
Warranty	1 year
Certifications	CE, RoHS
Electrical Data	
Input voltage	DC24V
Insulation class	Class III
Cable	1PC rubber cable 1M HO5RN-F 5x0.5mm square
Driver	Low voltage input, constant current output, excluding the transformer With builtin DMX decoder for DMX control
Construction Data	
IP rating	IP68 Waterproof
IK rating	IK09
Housing	Stainless steel 316
Protection finishing	Stainless steel 316
Trim	Stainless steel 316
Glass	Tempered Glass, T=2mm.
Loading capacity	700 kgs
Cable Gland	PG gland
Gasket	O-ring PMQ silicone seal
Accessories	
Spike	PVC spike as optional
Packaging	
Inner box size	mm
Carton size	44.5x33.5x14.5 cm (12 PCS / carton)

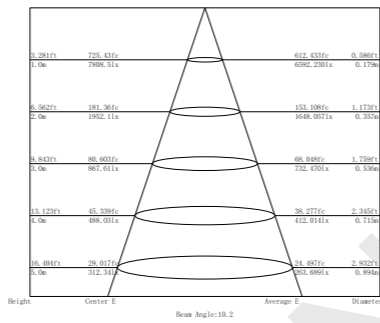
Dimension



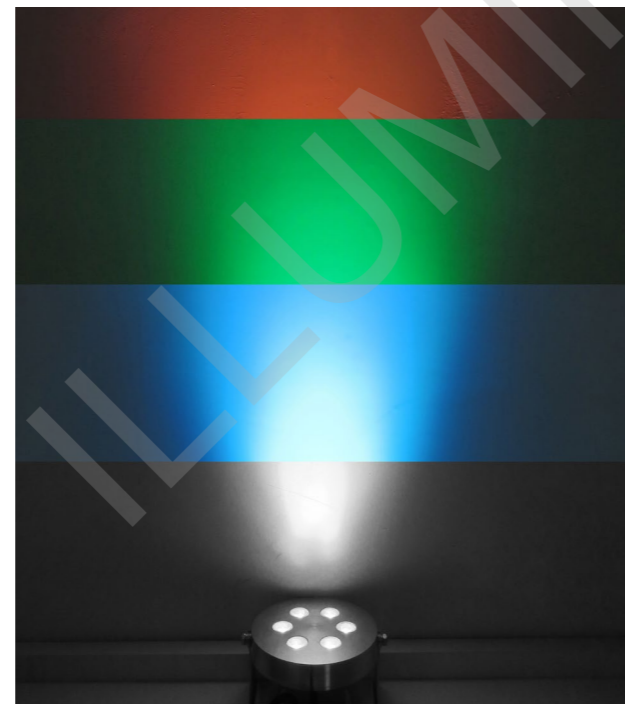
Light Distribution Curve (3000K, 10°)



Lux distance Curve (3000K, 10°)



Illumination Picture (10°)







Specialized in Exterior LED Lighting

GARDEN SPOT LIGHTS SERIES

Products Features

These products are designed with solid 6063 Aluminum housing CNC machined for better cooling performance, with passivated (anodizing) anti-corrosion finishing for housing, optics PMMA lens or reflector with wonderful light output, tempered glass for high loading capacity, silicone gasket and cable gland for waterproof IP67 and high quality CREE LED, EPISTAR LED.

We make several series of garden spot lights to meet different application with different power, color, beam angle, and the spot lights with replaceable GU10 lamp or MR16 lamp are available.

These products are with CE, RoHS certifications, and the SAA, PSE, UL or ETL certifications will be available in the coming future.

Application

These lights are widely used in the exterior or interior application, such as lighting columns, walls, architectural features, landscape features for the hotel, the garden, the park, the trees, the flowers etc.

Passivated

1 Year Warranty

CE  IP67 IK04



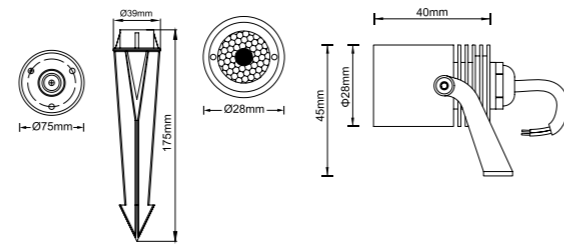


CE RoHS COMPLIANT IP67 IK04

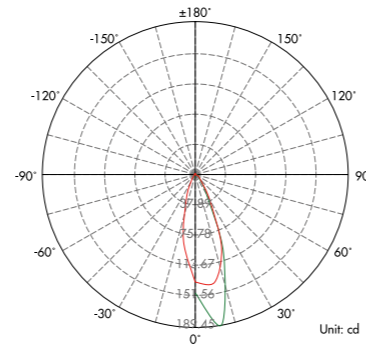
Passivated 1 Year Warranty

Parameter	
General Data	
Item No.	UL-1004-0300-A
Power	3 Watts (1 watt as optional)
LED type	1 PC 3W CREE XPG LED (1W LED as optional)
Luminous flux	90~100 lm
CCT	2700K, 3000K, 4000K, 6000K
CRI	80+
Beam angle	15°, 25°, 38°, 45°, 60°
Dimension	28 x 40 (mm) Diameter x Height
Cut out	/
Net weight	0.097 kgs
Warranty	1 year
Certifications	CE, RoHS
Electrical Data	
Input voltage	DC12V/DC24V
Insulation class	Class III
Cable	1PC PVC cable 1M H05RN-F 2x1mm square
Driver	Low voltage constant current output, excluding the transformer
Construction Data	
IP rating	IP67 Waterproof
IK rating	IK04
Housing	Solid Passivated (Anodizing) Aluminum CNC machined
Protection finishing	anodizing + powder coated painting in dark grey as standard, black or white colour as options
Trim	Passivated (Anodizing) Aluminum
Glass	Step tempered Glass. T=4mm.
Loading capacity	220 kgs
Cable Gland	PG7 IP67
Gasket	O-ring PMQ silicone seal
Accessories	
Spike	With PVC spike as spike spot lights (Standard)
Round base	With SS304 round base for wall mounting (optional)
Packaging	
Inner box size	95*60*55 mm
Carton size	32*31*24.5 cm (60PCS / carton)

Dimension



Light Distribution Curve (3000K,38°)



Lux distance Curve (3000K,38°)

	Illuminance at a Distance	
	Center Beam LUX	Beam Width V H
2m	33.42 LUX	1.1m 1.0m
4m	8.35 LUX	2.2m 2.0m
6m	3.71 LUX	3.3m 3.0m
8m	2.09 LUX	4.3m 4.0m
10m	1.34 LUX	5.4m 5.1m
12m	0.93 LUX	6.5m 6.1m

Vert.Spread:30.4 Horiz.Spread:28.4

Illumination Picture (38°)

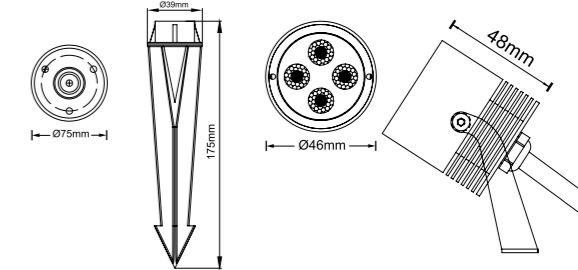


CE RoHS COMPLIANT IP67 IK04

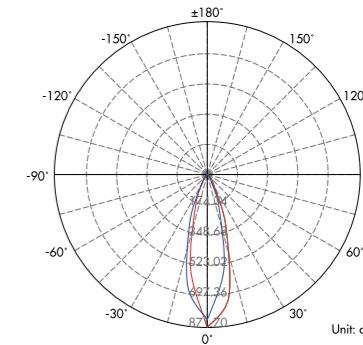
Passivated 1 Year Warranty

Parameter	
General Data	
Item No.	UL-4002-0400-A
Power	4 Watts
LED type	4 PCS 1W CREE XPE LED
Luminous flux	320~370 lm
CCT	2700K, 3000K, 4000K, 6000K
CRI	80+
Beam angle	25°, 40°, 60°
Dimension	46x48 (mm) Diameter x Height
Cut out	/
Net weight	0.246 kgs
Warranty	1 year
Certifications	CE, RoHS
Electrical Data	
Input voltage	DC24V
Insulation class	Class III
Cable	1PC rubber cable 1M H05RN-F 2x1mm square
Driver	Low voltage constant current output, excluding the transformer
Construction Data	
IP rating	IP67 Waterproof
IK rating	IK04
Housing	Solid Passivated (Anodizing) Aluminum CNC machined
Protection finishing	anodizing + powder coated painting in dark grey as standard, black or white or anodizing silver colour as options
Trim	Passivated (Anodizing) Aluminum
Glass	Step tempered Glass. T=4mm.
Loading capacity	220 kgs
Cable Gland	PG7 IP67
Gasket	O-ring PMQ silicone seal
Accessories	
Spike	With PVC spike as spike spot lights (Standard)
Round base	With SS304 round base for wall mounting (optional)
Packaging	
Inner box size	95*65*65 mm
Carton size	40*34.5*28 cm (80PCS / carton)

Dimension



Light Distribution Curve (3000K, 25°)

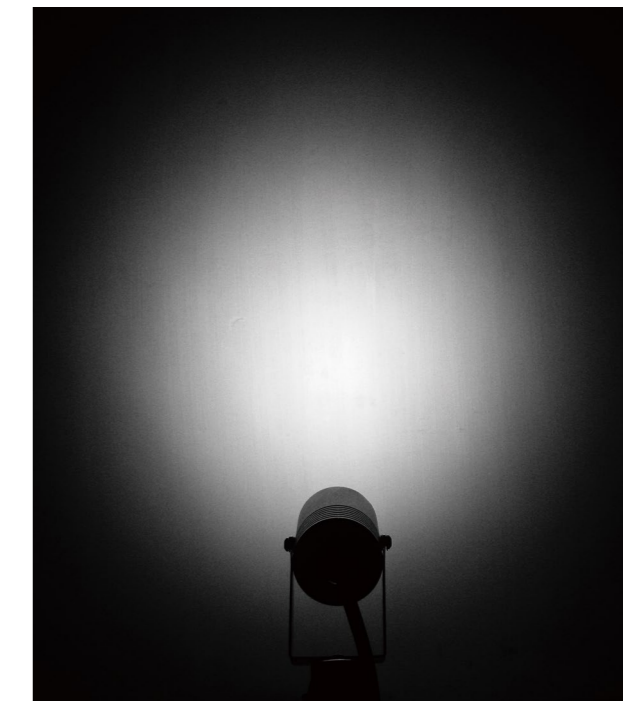


Lux distance Curve (3000K, 25°)

	Illuminance at a Distance	
	Center Beam LUX	Beam Width V H
2m	217.93 LUX	1.1m 1.1m
4m	54.48 LUX	2.2m 2.1m
6m	24.21 LUX	3.3m 3.2m
8m	13.62 LUX	4.5m 4.3m
10m	8.72 LUX	5.6m 5.3m
12m	6.05 LUX	6.7m 6.4m

Vert.Spread:31.2 Horiz.Spread:29.9

Illumination Picture (25°)

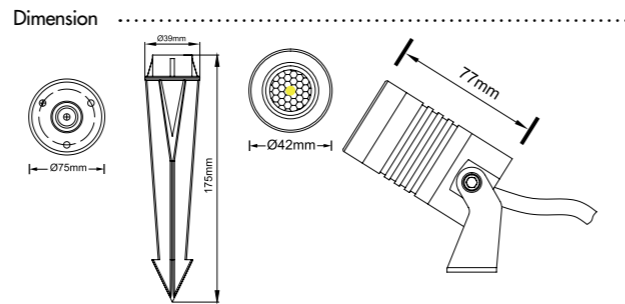




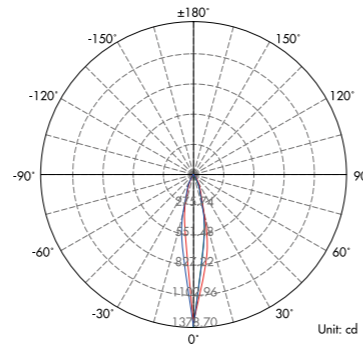
CE RoHS COMPLIANT IP67 IK04

Passivated 1 Year Warranty

Parameter	
General Data	
Item No.	UL-1010-0500-BH
Power	5 Watts
LED type	1 PC 5W CREE COB LED
Luminous flux	350~400 lm
CCT	2700K, 3000K, 4000K, 6000K
CRI	80+
Beam angle	Reflector 15°, 25°, [38° optional] (lens 15°, 24°, 36°, 60°+honey comb optional)
Dimension	42 x 77 [mm] Diameter x Height
Cut out	/
Net weight	0.29 kgs
Warranty	1 year
Certifications	CE, RoHS
Electrical Data	
Input voltage	AC95-265V as standard (DC 12V or DC 24V as optional)
Insulation class	Class I
Cable	1PC rubber cable 1M H05RN-F 3x1mm square
Driver	Built-in high voltage constant current driver with transformer
Construction Data	
IP rating	IP67 Waterproof
IK rating	IK04
Housing	Solid Passivated (Anodizing) Aluminum CNC machined anodizing + powder coated painting in dark grey as standard, black or white as options
Protection finishing	
Trim	Passivated (Anodizing) Aluminum
Glass	Step tempered Glass. T=3mm.
Loading capacity	220 kgs
Cable Gland	PG7 IP67
Gasket	O-ring PMQ silicone seal
Accessories	
Spike	With PVC spike as spike spot lights (Standard)
Round base	With SS304 round base for wall mounting (optional)
Packaging	
Inner box size	116*95*48 mm
Carton size	49*25*16 cm (30 PCS / carton)



Light Distribution Curve (3000K, 25°)

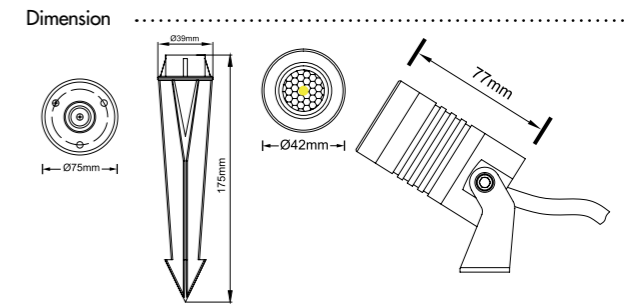
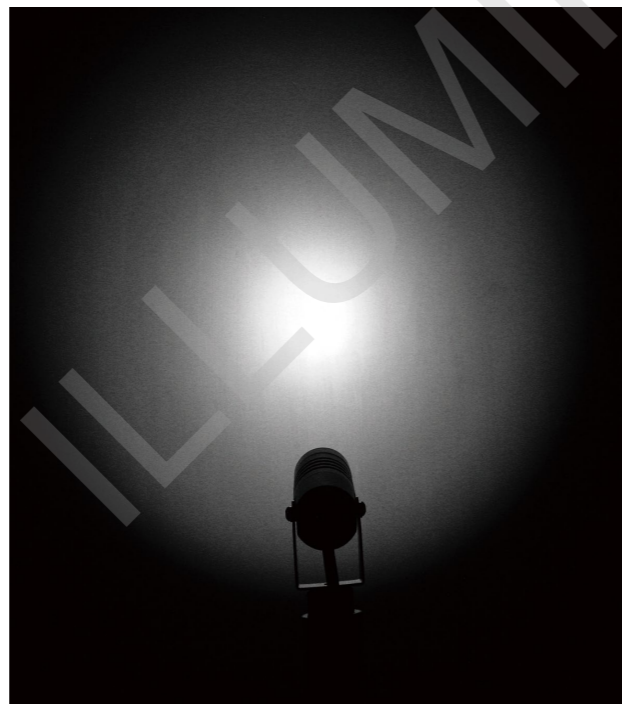


Lux distance Curve (3000K, 25°)

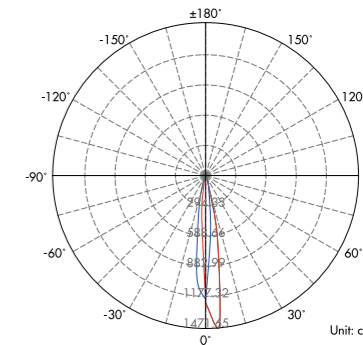
Distance (m)	Illuminance at a Distance	
	Center Beam LUX	Beam Width V x H
2m	334.45 LUX	0.6m x 0.6m
4m	83.61 LUX	1.3m x 1.2m
6m	37.16 LUX	1.9m x 1.8m
8m	20.90 LUX	2.5m x 2.4m
10m	13.38 LUX	3.2m x 3.0m
12m	9.29 LUX	3.8m x 3.6m

Vert.Spread:17.9 Horiz.Spread:17.3

Illumination Picture (25°)



Light Distribution Curve (3000K, 20°)



Lux distance Curve (3000K, 20°)

Distance (m)	Illuminance at a Distance	
	Center Beam LUX	Beam Width V x H
2m	308.51 LUX	0.4m x 0.4m
4m	77.13 LUX	0.9m x 0.8m
6m	34.28 LUX	1.3m x 1.3m
8m	19.28 LUX	1.7m x 1.7m
10m	12.34 LUX	2.2m x 2.1m
12m	8.57 LUX	2.6m x 2.5m

Vert.Spread:12.4 Horiz.Spread:12.0

Illumination Picture (20°)

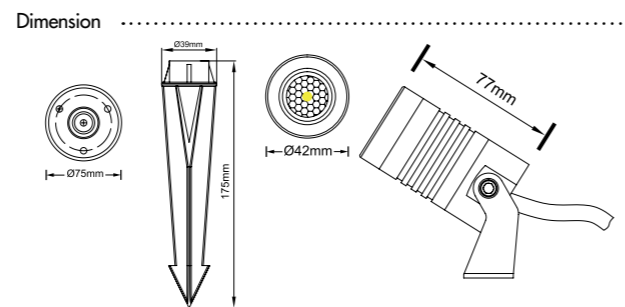


CE RoHS COMPLIANT IP67 IK04

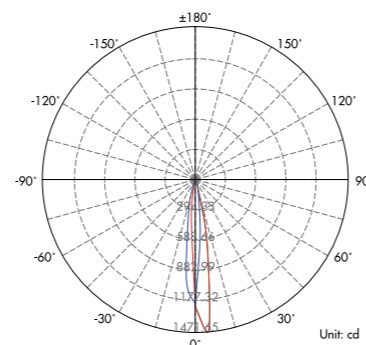
Passivated 1 Year Warranty

Parameter	
General Data	
Item No.	UL-1010-0500-CH
Power	3 Watts
LED type	1 PC 3W CREE XPE LED
Luminous flux	110~130 lm
CCT	2700K, 3000K, 4000K, 6000K
CRI	80+
Beam angle	20°, 30°, 40°, 60°
Dimension	42 x 77 [mm] Diameter x Height
Cut out	/
Net weight	0.29 kgs
Warranty	1 year
Certifications	CE, RoHS
Electrical Data	
Input voltage	AC95-265V
Insulation class	Class I
Cable	1PC rubber cable 1M H05RN-F 3x1mm square
Driver	Built-in high voltage constant current driver with transformer
Construction Data	
IP rating	IP67 Waterproof
IK rating	IK04
Housing	Solid Passivated (Anodizing) Aluminum CNC machined anodizing + powder coated painting in dark grey as standard, black or white or anodizing silver colour as options
Protection finishing	
Trim	Passivated (Anodizing) Aluminum
Glass	Step tempered Glass. T=3mm.
Loading capacity	220 kgs
Cable Gland	PG7 IP67
Gasket	O-ring PMQ silicone seal
Accessories	
Spike	With PVC spike as spike spot lights (Standard)
Round base	With SS304 round base for wall mounting (optional)
Packaging	
Inner box size	116*95*48 mm
Carton size	49*25*16 cm (30 PCS / carton)





Light Distribution Curve (3000K, 20°)

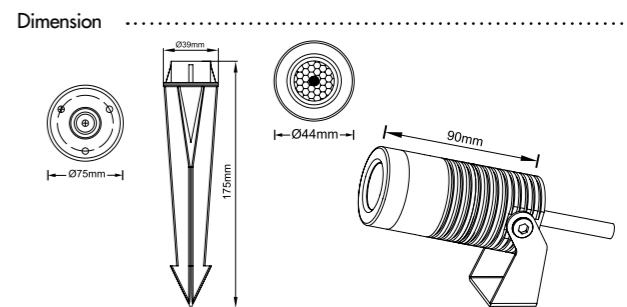


Lux distance Curve (3000K, 20°)

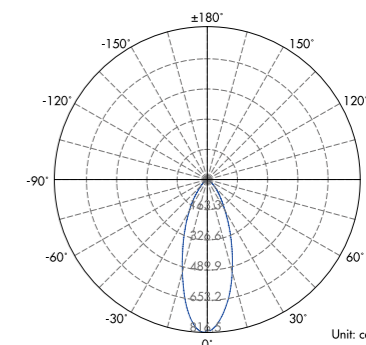
Distance (m)	Illuminance at a Distance	
	Center Beam LUX	Beam Width V H
2m	308.51 LUX	0.4m 0.4m
4m	77.13 LUX	0.9m 0.8m
6m	34.28 LUX	1.3m 1.3m
8m	19.28 LUX	1.7m 1.7m
10m	12.34 LUX	2.2m 2.1m
12m	8.57 LUX	2.6m 2.5m

Vert.Spread:12.4 Horiz.Spread:12.0

Illumination Picture (20°)



Light Distribution Curve (3000K, 25°)



Lux distance Curve (3000K, 25°)

Distance (m)	Illuminance at a Distance	
	Center Beam LUX	Beam Width V H
2m	24.4756	0.46 0.46
4m	6.1189	0.92 0.92
6m	3.3822	1.38 1.38
8m	2.0264	1.84 1.84
10m	1.3822	2.30 2.30
12m	0.9875	2.76 2.76

Vert.Spread:12.4 Horiz.Spread:12.0

Illumination Picture (25°)



CE RoHS COMPLIANT IP67 IK04

Passivated 1 Year Warranty

Parameter	
General Data	
Item No.	UL-1010-0500-CH
Power	5 Watts
LED type	1 PC 5W CREE XPG LED
Luminous flux	330~360 lm
CCT	2700K, 3000K, 4000K, 6000K
CRI	80+
Beam angle	20°, 30°, 40° 60°
Dimension	42 x 77 (mm) Diameter x Height
Cut out	/
Net weight	0.29 kgs
Warranty	1 year
Certifications	CE, RoHS
Electrical Data	
Input voltage	AC95-265V
Insulation class	Class I
Cable	1PC rubber cable 1M H05RN-F 3x1mm square
Driver	Built-in high voltage constant current driver with transformer
Construction Data	
IP rating	IP67 Waterproof
IK rating	IK04
Housing	Solid Passivated (Anodizing) Aluminum CNC machined
Protection finishing	anodizing + powder coated painting in dark grey as standard, black or white or anodizing silver colour as options
Trim	Passivated (Anodizing) Aluminum
Glass	Step tempered Glass. T=3mm.
Loading capacity	220 kgs
Cable Gland	PG7 IP67
Gasket	O-ring PMQ silicone seal
Accessories	
Spike	With Aluminium spike as spike spot lights (Standard)
Round base	With SS304 round base for wall mounting (optional)
Packaging	
Inner box size	116*95*48 mm
Carton size	49*25*16 cm (30 PCS / carton)

CE RoHS COMPLIANT IP67 IK04

Passivated 1 Year Warranty

Parameter	
General Data	
Item No.	UL-1010-0800-AH / UL-1010-0800-BH
Power	8 Watts
LED type	1 PC 8W CREE COB LED
Luminous flux	560~640 lm
CCT	2700K, 3000K, 4000K, 6000K
CRI	80+
Beam angle	anodizing + powder coated painting in dark grey as standard, black or white as options
Dimension	44 x 90 (mm) Diameter x Height
Cut out	/
Net weight	0.39 kgs
Warranty	1 year
Certifications	CE, RoHS
Electrical Data	
Input voltage	AC95-265V sa standard (DC 12V or DC 24V as optional)
Insulation class	Class I
Cable	1PC rubber cable 1M H05RN-F 3x1mm square
Driver	Built-in high voltage constant current driver with transformer
Construction Data	
IP rating	IP67 Waterproof
IK rating	IK04
Housing	Solid Passivated (Anodizing) Aluminum CNC machined
Protection finishing	20~25µm thickness anodized film for housing. Dark grey standard, silver color as options.
Trim	Passivated (Anodizing) Aluminum
Glass	Step tempered Glass. T=3mm.
Loading capacity	220 kgs
Cable Gland	PG7 IP67
Gasket	O-ring PMQ silicone seal
Accessories	
Spike	With PVC spike as spike spot lights (Standard)
Round base	With SS304 round base for wall mounting (optional)
Packaging	
Inner box size	130*97*50 mm
Carton size	51*28*17 cm (30 PCS / carton)

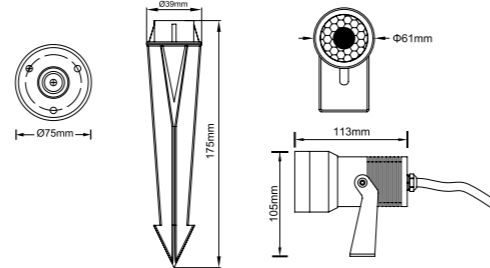


CE RoHS COMPLIANT IP67 IK04

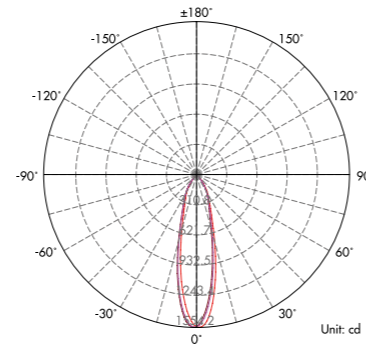
Passivated 1 Year Warranty

Parameter	
General Data	
Item No.	UL-1012-1200-AH
Power	12W±10% (or 8W ±10% as options)
LED type	1 PC 12V Cree COB LED
Luminous flux	1150~1250 lm
CCT	2700K, 3000K, 4000K, 6000K
CRI	80+
Beam angle	Reflector 24°, 38°, 60° (lens 10°/23°/36° + honeycomb optional)
Dimension	61 x 113 (mm) Diameter x Height
Cut out	/
Net weight	0.5 kgs
Warranty	1 year
Certifications	CE, RoHS
Electrical Data	
Input voltage	AC95-265V
Insulation class	Class I
Cable	1PC rubber cable 1M H05RN-F 3x1mm square
Driver	Built-in high voltage constant current driver with transformer
Construction Data	
IP rating	IP67 Waterproof
IK rating	IK04
Housing	Solid Passivated (Anodizing) Aluminum CNC machined
Protection finishing	anodizing + powder coated painting in dark grey as standard, black or white as options
Trim	Passivated (Anodizing) Aluminum
Glass	Step tempered Glass. T=3mm.
Loading capacity	220 kgs
Cable Gland	PG7 IP67
Gasket	O-ring PMQ silicone seal
Accessories	
Spike	With PVC spike as spike spot lights (Standard)
Round base	With SS304 round base for wall mounting (optional)
Packaging	
Inner box size	130*115*80mm
Carton size	36.5*28*26cm (18PCS / carton)

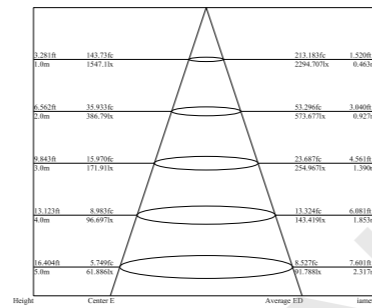
Dimension



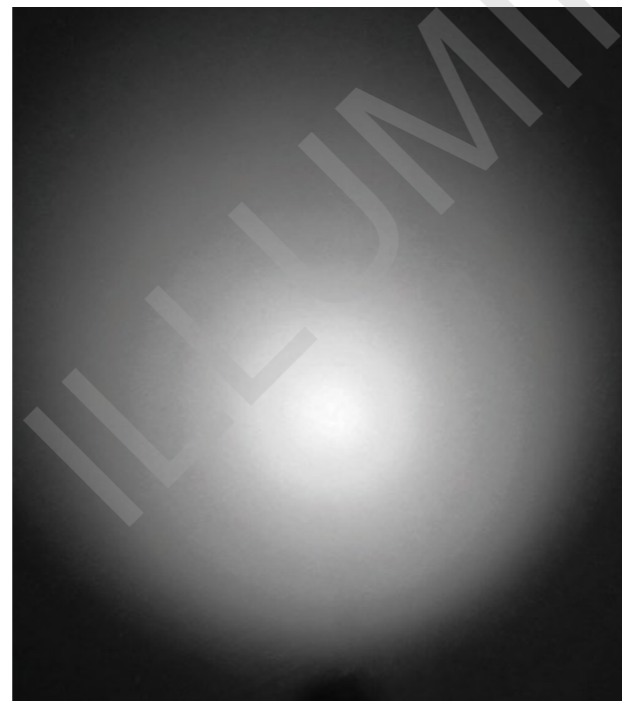
Light Distribution Curve (3000K, 25°)



Lux distance Curve (3000K, 25°)



Illumination Picture (25°)

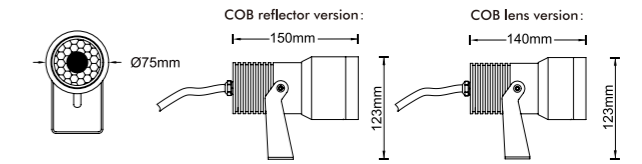


CE RoHS COMPLIANT IP65 IK04

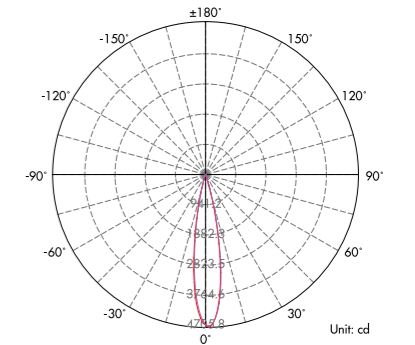
Passivated 1 Year Warranty

Parameter	
General Data	
Item No.	UL-1012-1800-AH
Power	18W±10%
LED type	1 PC 18W Cree CXA1512 COB LED
Luminous flux	Reflector version: 1700lm±10%; COB lens version: 1500lm±10%
CCT	2700K, 3000K, 4000K, 6000K
CRI	80+
Beam angle	Reflector version: 15°, 23°, 38°, 45°, 60°; COB lens version: 10°, 23°, 36°
Dimension	75*(reflector 150 or lens 140)*123 (mm) Diameter x Lengthx Height
Cut out	/ mm
Net weight	Reflector version: 0.95 kgs; COB lens version: 0.9kgs
Warranty	1 year
Certifications	CE, RoHS
Electrical Data	
Input voltage	AC100-265V
Insulation class	Class I
Cable	1PC rubber cable 1M H05RN-F 3 x 1mm square
Driver	built-in constant current driver
Construction Data	
IP rating	IP67 Waterproof
IK rating	IK04
Housing	Solid Passivated (Anodizing) Aluminum CNC machined
Protection finishing	anodizing + powder coated painting in dark grey as standard, black or white as options
Trim	Aluminum
Glass	Tempered glass T=3mm
Loading capacity	220 kgs
Cable Gland	PG gland
Gasket	silicone ring + silicone glue seal
Accessories	
Spike	with 205mm height Aluminium spike for ground installation
Pedal	with SS304 Pedal that can be used with spike for pushing the spike light into the ground by foot
Round base	With SS304 base in dark grey as optional for concrete ground installation
Shield	80mm diameter shield optional for anti-glare
Honeycomb	honeycomb optional for anti-glare
Packaging	
Inner box size	200*150*85 mm
Carton size	42*32*28 cm (12 PCS / carton)

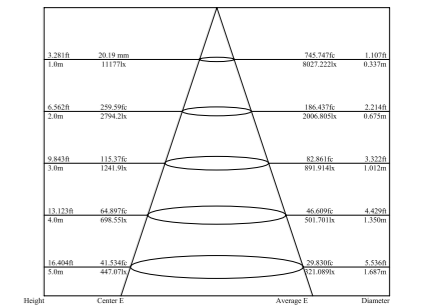
Dimension



Light Distribution Curve (3000K, 23° lens)

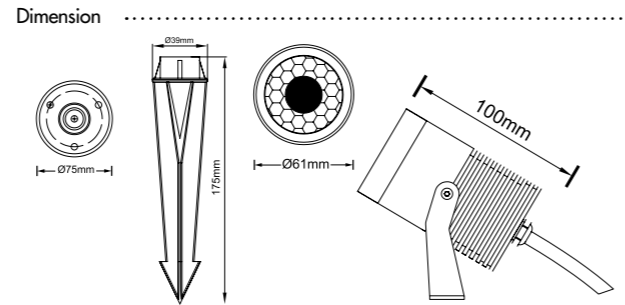


Lux distance Curve (3000K, 23° lens)



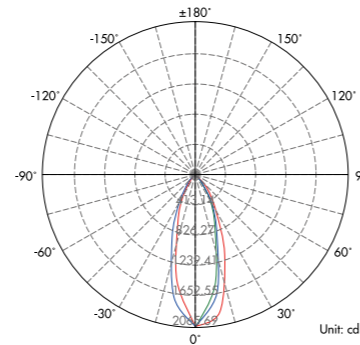
Illumination Picture (23° lens)





Dimension

Light Distribution Curve (3000K, 25°)

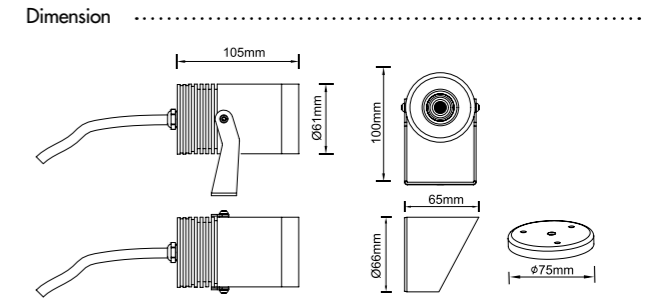


Lux distance Curve (3000K, 25°)

Distance (m)	Illuminance at a Distance	
	Center Beam LUX	Beam Width V H
2m	511.69 LUX	1.4m 1.3m
4m	127.92 LUX	2.7m 2.6m
6m	56.85 LUX	4.1m 3.9m
8m	31.98 LUX	5.4m 5.2m
10m	20.47 LUX	6.8m 6.6m
12m	14.21 LUX	8.2m 7.9m

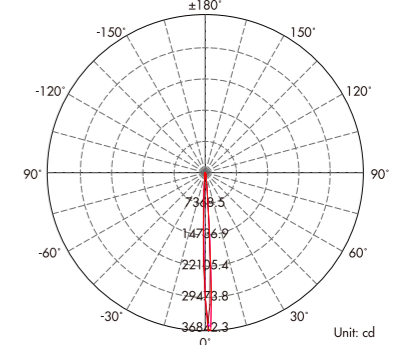
Vert.Spread:37.6 Horiz.Spread:36.3

Illumination Picture (25°)



Dimension

Light Distribution Curve (3000K, 3°)



Lux distance Curve (3000K, 3°)

Distance (m)	Illuminance at a Distance	
	Center Beam LUX	Beam Width V H
2m	2785.90	0.28m 0.28m
4m	696.47	0.57m 0.57m
6m	306.10	0.85m 0.85m
8m	187.31	1.14m 1.14m
10m	131.82	1.42m 1.42m
12m	98.84	1.71m 1.71m

Beam Angle: 3.9 Average: 3.5 Diameter: 3.6

Illumination Picture (3°)



CE RoHS COMPLIANT IP67 IK04

Passivated 1 Year Warranty

Parameter

General Data	
Item No.	UL-15W-COB-1500-BH
Power	1.5 Watts
LED type	1 PC CREE COB LED
Luminous flux	1200~1350 lm
CCT	2700K, 3000K, 4000K, 6000K
CRI	80+
Beam angle	25°, 38°, 60° (lens 10° 23° 36° + honey comb optional)
Dimension	61 x 100 (mm) Diameter x Height
Cut out	/
Net weight	0.58 kgs
Warranty	1 year
Certifications	CE, RoHS
Electrical Data	
Input voltage	AC100-265V (DC24V as optional)
Insulation class	Class I
Cable	1PC rubber cable 1M H05RN-F 3x 1mm square
Driver	Built-in high voltage constant current driver with transformer
Construction Data	
IP rating	IP67 Waterproof
IK rating	IK04
Housing	Solid Passivated (Anodizing) Aluminum CNC machined
Protection finishing	anodizing + powder coated painting in dark grey as standard, black or white as options
Trim	Passivated (Anodizing) Aluminum
Glass	Step tempered Glass. T=3mm.
Loading capacity	220 kgs
Cable Gland	PG7 IP67
Gasket	O-ring PMQ silicone seal
Accessories	
Spike	With PVC spike as spike spot lights (Standard)
Round base	With SS304 round base for wall mounting (optional)
Packaging	
Inner box size	130*115*80mm
Carton size	36.5*28*26cm (18PCS / carton)

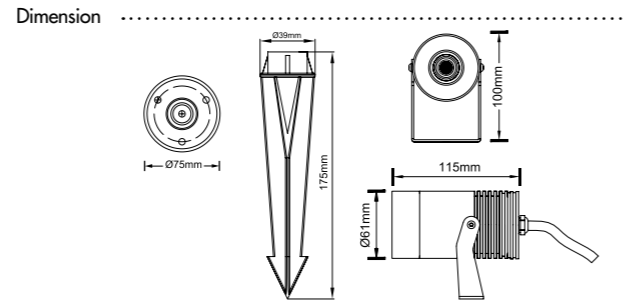
CE RoHS COMPLIANT IP67 IK04

Passivated 1 Year Warranty

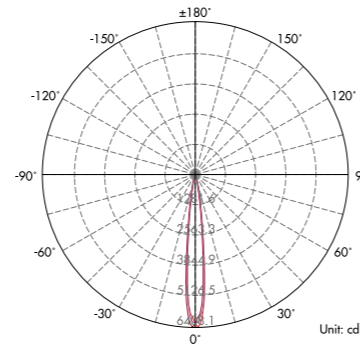
Parameter

General Data	
Item No.	UL-1019-1200-BH
Power	12 Watts +10%
LED type	1 PC CREE COB LED
Luminous flux	720lm +10%
CCT	2700K, 3000K, 4000K, 5700K, 6500K
CRI	80+
Beam angle	3°
Dimension	Ø61x105 (mm) Diameter x length
Cut out	/ mm
Net weight	0.58 kgs
Warranty	1 year
Certifications	CE, RoHS
Electrical Data	
Input voltage	AC100-265V
Insulation class	Class I
Cable	1PC rubber cable 1m H05RN-F 3 x 1mm square
Driver	built-in constant current driver
Construction Data	
IP rating	IP67 Waterproof
IK rating	IK04
Housing	Solid Passivated (Anodizing) Aluminum CNC machined
Protection finishing	anodizing + powder coated painting in dark grey as standard, black or white as options
Trim	Aluminium
Glass	Tempered Glass
Loading capacity	/
Cable Gland	PG gland
Gasket	silicone ring + silicone glue seal
Accessories	
Spike	With PVC spike as spike spot lights (Standard)
Round base	With SS304 round base for wall mounting (optional)
Shield	Anti-glare shield options
Packaging	
Inner box size	130*115*80mm
Carton size	36.5*28*26cm (18PCS / carton)

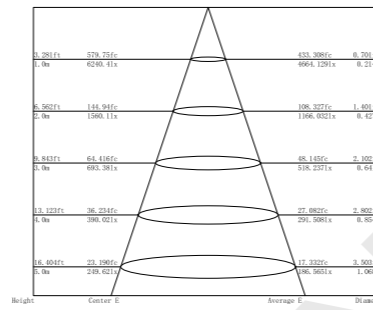




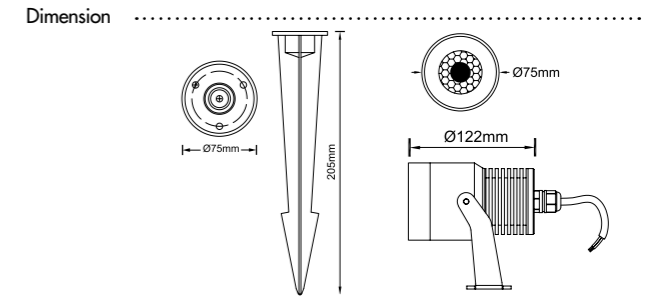
Light Distribution Curve (3000K, 10°)



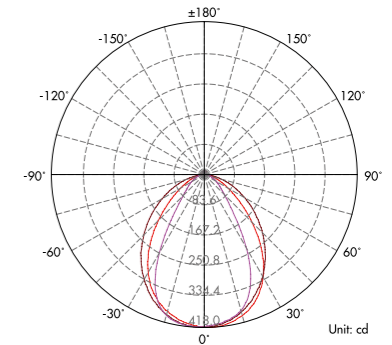
Lux distance Curve (3000K, 10°)



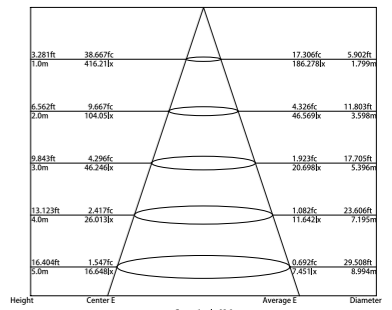
Illumination Picture (10°)



Light Distribution Curve (3000K, 36°)



Lux distance Curve (3000K, 36°)



Illumination Picture (36°)



CE RoHS COMPLIANT IP67 IK04

Passivated 1 Year Warranty

Parameter	
General Data	
Item No.	UL-1019-1200-AH
Power	12 Watts
LED type	1 PC 12V CREE XHP35 LED
Luminous flux	450lm+10%
CCT	2700K, 3000K, 4000K, 6000K
CRI	80+
Beam angle	4°
Dimension	61 x 115 (mm) Diameter x Height
Cut out	/
Net weight	0.58 kgs
Warranty	1 year
Certifications	CE, RoHS
Electrical Data	
Input voltage	AC100-265V
Insulation class	Class I
Cable	1PC rubber cable 1M H05RN-F 3x1mm square
Driver	Built-in high voltage constant current driver with transformer
Construction Data	
IP rating	IP67 Waterproof
IK rating	IK04
Housing	Solid Passivated (Anodizing) Aluminum CNC machined
Protection finishing	anodizing + powder coated painting in dark grey as standard, black or white as options
Trim	Passivated (Anodizing) Aluminum
Glass	Step tempered Glass. T=3mm.
Loading capacity	220 kgs
Cable Gland	PG7 IP67
Gasket	O-ring PMQ silicone seal
Accessories	
Spike	With PVC spike as spike spot lights (Standard)
Round base	With SS304 round base for wall mounting (optional)
Packaging	
Inner box size	130*125*70 mm
Carton size	52.5*27.5*23 cm (24PCS / carton)

CE RoHS COMPLIANT IP67 IK04

Passivated 1 Year Warranty

Parameter	
General Data	
Item No.	UL-8W-COB-AH / UL-8W-COB-0800-AH
Power	8 Watts / 12 watts
LED type	1 PC 8W CREE COB LED / 1 PC 12W CREE COB LED
Luminous flux	500~550 lm / 960~1000lm for 12W
CCT	2700K, 3000K, 4000K, 6000K
CRI	80+
Beam angle	24°, 36°, 60°
Dimension	75*122 (mm) Diameter x Height
Cut out	/
Net weight	1.27 kgs
Warranty	1 year
Certifications	CE, RoHS
Electrical Data	
Input voltage	AC100-265V as standard (DC 12V or DC 24V as optional)
Insulation class	Class I
Cable	1PC rubber cable 1M H05RN-F 3x1mm square
Driver	Built-in high voltage constant current driver with transformer
Construction Data	
IP rating	IP67 Waterproof
IK rating	IK04
Housing	Solid Passivated (Anodizing) Aluminum CNC machined
Protection finishing	anodizing + powder coated painting in dark grey as standard, black or white as options
Trim	Passivated (Anodizing) Aluminum
Glass	Step tempered Glass. T=3mm.
Loading capacity	220 kgs
Cable Gland	PG7 IP67
Gasket	O-ring PMQ silicone seal
Accessories	
Spike	With Aluminium spike as spike spot lights (Standard)
Round base	With SS304 round base for wall mounting (optional)
Packaging	
Inner box size	230*120*80mm
Carton size	53x 27x 28cm (15 PCS / carton)

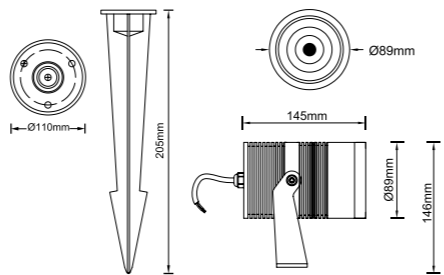


CE RoHS COMPLIANT IP67 IK04

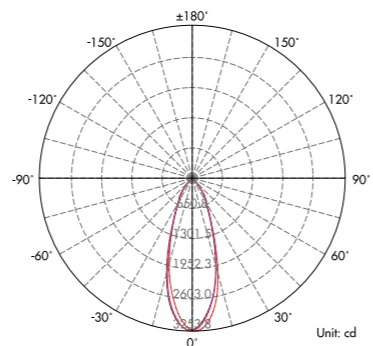
Passivated 1 Year Warranty

Parameter	
General Data	
Item No.	UL-25W-COB-2500-BH
Power	25 Watts
LED type	1 PC 25W CREE COB LED
Luminous flux	2100~2300 lm
CCT	2700K, 3000K, 4000K, 6000K
CRI	80+
Beam angle	15°, 23°, 38°, 45°, 60°
Dimension	89*145 (mm) Diameter x Height
Cut out	/
Net weight	1.37 kgs
Warranty	1 year
Certifications	CE, RoHS
Electrical Data	
Input voltage	AC100-265V as standard (DC 24V as optional)
Insulation class	Class I
Cable	1PC rubber cable 1M H05RN-F 3x1mm square
Driver	Built-in high voltage constant current driver with transformer
Construction Data	
IP rating	IP67 Waterproof
IK rating	IK04
Housing	Solid Passivated (Anodizing) Aluminum CNC machined
Protection finishing	anodizing + powder coated painting in dark grey as standard, black or white as options
Trim	Passivated (Anodizing) Aluminum
Glass	Step tempered Glass. T=4mm.
Loading capacity	220 kgs
Cable Gland	PG7 IP67
Gasket	O-ring PMQ silicone seal
Accessories	
Spike	With Aluminium spike as spike spot lights (Standard)
Round base	With SS304 round base for wall mounting (optional)
Packaging	
Inner box size	160*140*110 mm
Carton size	34.5*30.5*24.5 cm (8 PCS/ carton)

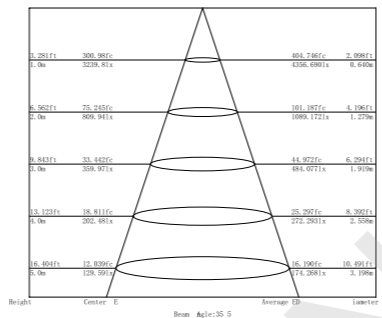
Dimension



Light Distribution Curve (3000K, 38°)



Lux distance Curve (3000K, 38°)



Illumination Picture (38°)

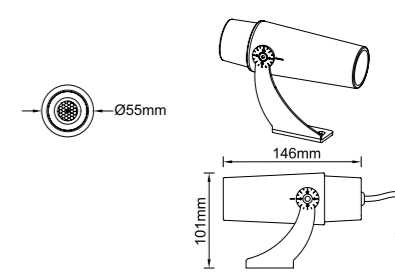


CE RoHS COMPLIANT IP65 IK04

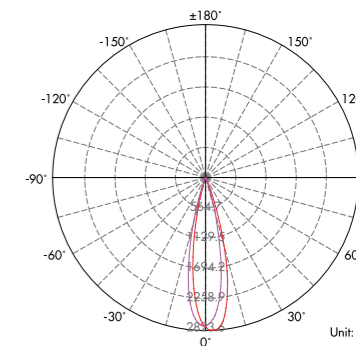
1 Year Warranty

Parameter	
General Data	
Item No.	DC12-24V: UL-8W-COB-0800K / AC100-265V: UL-8W-COB-0800KH
Power	8 Watts ± 10%
LED type	1 PC 8W CREE CXA1304 COB LED
Luminous flux	400lm ± 10%
CCT	2700K, 3000K, 4500K, 5500K, 6000K
CRI	80+
Beam angle	15°, 25°
Dimension	Ø55*146*101 (mm) (Diameter x Length x height)
Cut out	/ mm
Net weight	0.55 kgs
Warranty	1 year
Certifications	CE, RoHS
Electrical Data	
Input voltage	DC12V-24V or AC100-265V
Insulation class	Class III or I
Cable	1PC rubber cable 1M H05RN-F 2 or 3 x 1mm square
Driver	DC24V: constant low voltage input, constant current output driver for LED AC100-265V: built-in constant current driver
Construction Data	
IP rating	IP67 Waterproof
IK rating	IK04
Housing	Solid Passivated (Anodizing) Aluminum CNC machined
Protection finishing	anodizing + powder coated painting in dark grey as standard, black or white as options
Trim	Aluminum
Glass	Tempered glass T=3mm
Loading capacity	220 kgs
Cable Gland	PG gland
Gasket	silicone ring + silicone glue seal
Accessories	
Spike	with 205mm height Aluminium spike for ground installation with SS304 Pedal that can be used with spike for pushing the spike light into the ground by foot
Pedal	With SS304 base in dark grey as optional for concrete ground installation
Packaging	
Inner box size	180*95*90 mm
Carton size	50*38*29 cm (30 PCS / carton)

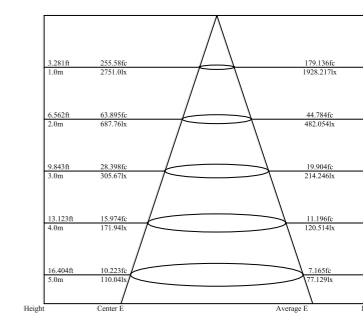
Dimension



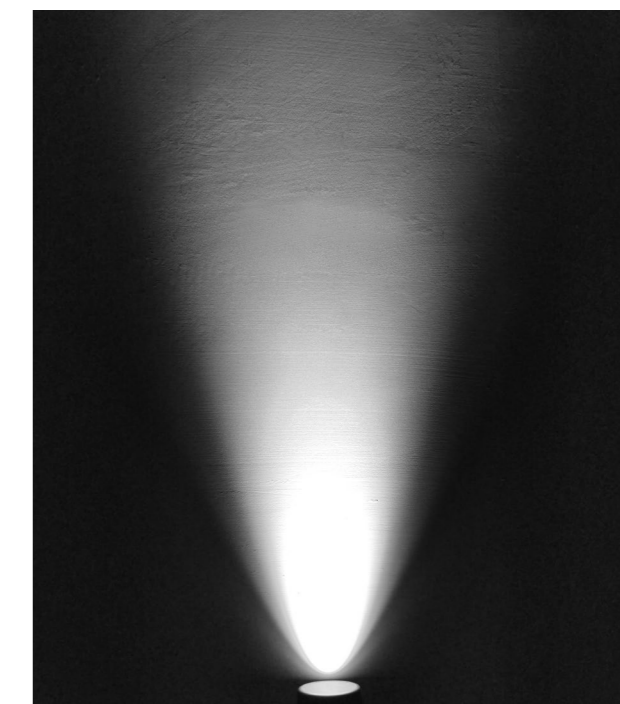
Light Distribution Curve (3000K, 25°)

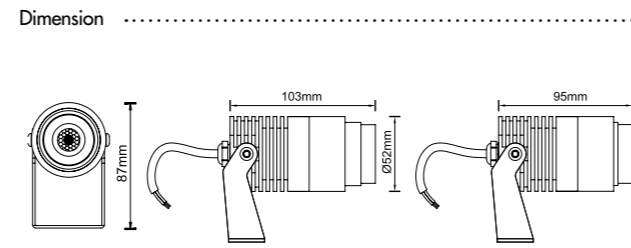
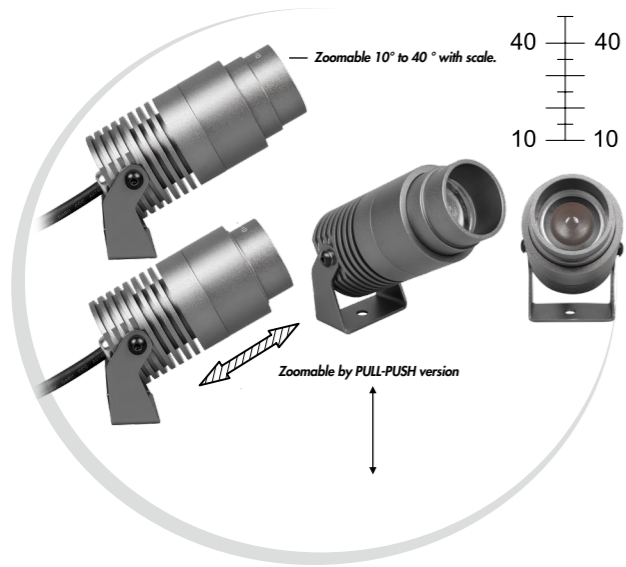


Lux distance Curve (3000K, 25°)

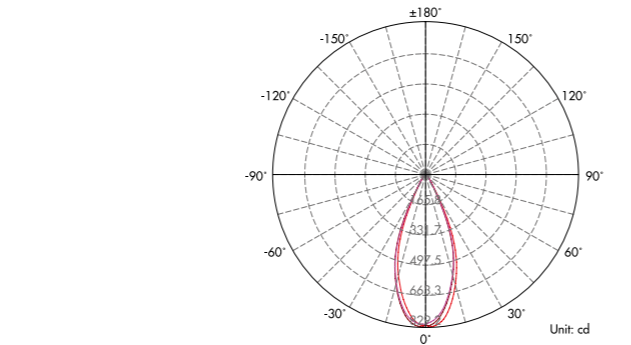


Illumination Picture (25°)





Dimension



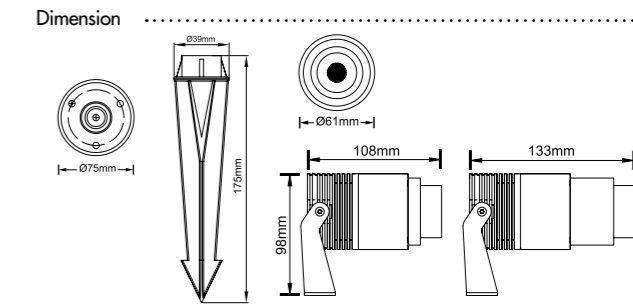
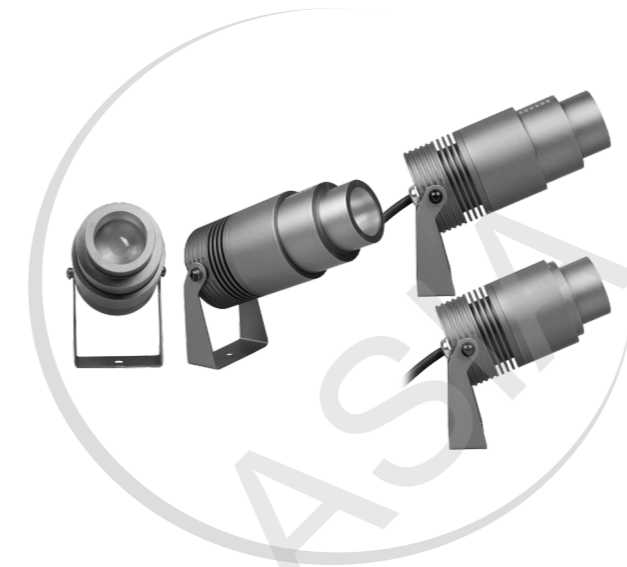
Light Distribution Curve (3000K, 40°)

Height	Center E	Beam Angle: 40.0	Average E	Diameter
3.281ft	75.919ft		50.517ft	2.516ft
1.0m	817.20lx		543.770lx	0.767m
6.562ft	18.980ft		12.629ft	5.031ft
2.0m	204.30lx		135.943lx	1.534m
9.843ft	8.435ft		5.613ft	7.547ft
3.0m	90.800lx		60.419lx	2.300m
13.123ft	4.745ft		3.157ft	10.063ft
4.0m	51.075lx		33.986lx	3.067m
16.404ft	3.037ft		2.021ft	12.578ft
5.0m	32.688lx		21.751lx	3.834m

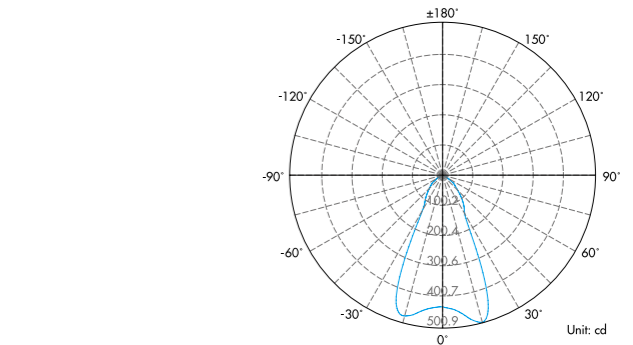
Lux distance Curve (3000K, 40°)



Illumination Picture (40°)



Dimension



Light Distribution Curve (3000K, 60°)

Height	Center E	Beam Angle: 60.0	Average E	Diameter
3.281ft	75.919ft		49.432ft	2.812ft
1.0m	628.321lx		538.221lx	0.768m
6.562ft	9.970ft		13.489ft	5.102ft
2.0m	107.381lx		132.502lx	1.501m
9.843ft	5.430ft		5.315ft	7.712ft
3.0m	67.721lx		96.302lx	2.301m
13.123ft	2.840ft		3.187ft	10.202ft
4.0m	26.501lx		33.702lx	3.134m
16.404ft	1.080ft		1.385ft	12.602ft
5.0m	11.181lx		12.702lx	3.934m

Lux distance Curve (3000K, 60°)



Illumination Picture (60°)

CE RoHS COMPLIANT IP67 IK04

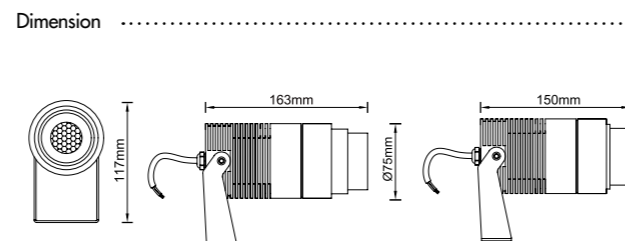
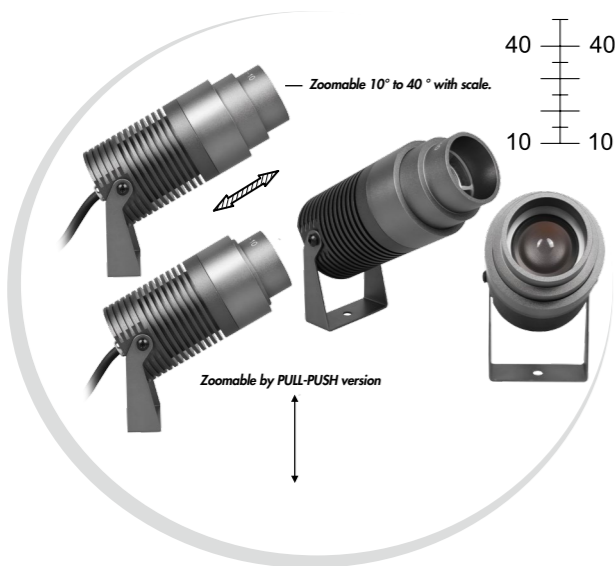
Passivated Zoomable
1 Year Warranty

Parameter	
General Data	
Item No.	UL-8W-COB-0800FH(PULL)
Power	8 watts ±10%
LED type	1 PC 8W TOYONIA COB LED
Luminous flux	10°: 200~250, 40°: 360~400 lm
CCT	2700K, 3000K, 4000K, 6000K
CRI	80+
Beam angle	Zoomable 10° to 40° adjustable
Dimension	52 x 103 (mm) Diameter x Height
Cut out	/
Net weight	0.46 kgs
Warranty	1 year
Certifications	CE, RoHS
Electrical Data	
Input voltage	AC100~245V as standard (DC24V as options)
Insulation class	Class I
Cable	1PC rubber cable 1M H05RN-F 3x1mm square
Driver	Built-in high voltage constant current driver with transformer
Construction Data	
IP rating	IP67 Waterproof
IK rating	IK04
Housing	Solid Passivated (Anodizing) Aluminum CNC machined
Protection finishing	anodizing + powder coated painting in dark grey as standard, black or white as options
Trim	Passivated (Anodizing) Aluminum
Glass	Step tempered Glass. T=2mm
Loading capacity	220 kgs
Cable Gland	PG7 IP67
Gasket	O-ring PMQ silicone seal
Accessories	
Spike	With black PVC spike as standard
Round base	With SS304 round base as optional
Packaging	
Inner box size	180*105*65 mm
Carton size	55*23.5*14 cm (20 PCS / carton)

CE RoHS COMPLIANT IP67 IK04

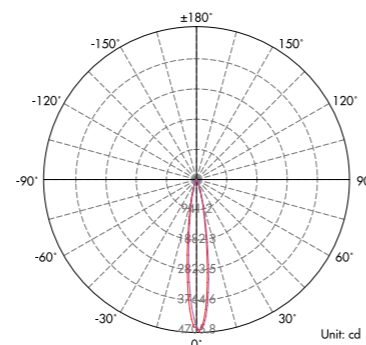
Passivated 1 Year Warranty

Parameter	
General Data	
Item No.	UL-12W-COB-1200BH
Power	12 Watts
LED type	1 PC 12W CREE COB LED
Luminous flux	500~550 lm
CCT	2700K, 3000K, 4000K, 6000K
CRI	80+
Beam angle	Zoom 10° to 60° adjustable
Dimension	61 x 133 (mm) Diameter x Height
Cut out	/
Net weight	0.62 kgs
Warranty	1 year
Certifications	CE, RoHS
Electrical Data	
Input voltage	AC95-265V
Insulation class	Class I
Cable	1PC rubber cable 1M H05RN-F 3x1mm square
Driver	Built-in high voltage constant current driver with transformer
Construction Data	
IP rating	IP67 Waterproof
IK rating	IK04
Housing	Solid Passivated (Anodizing) Aluminum CNC machined
Protection finishing	anodizing + powder coated painting in dark grey as standard, black or white as options
Trim	Passivated (Anodizing) Aluminum
Glass	Step tempered Glass. T=3mm.
Loading capacity	220 kgs
Cable Gland	PG7 IP67
Gasket	O-ring PMQ silicone seal
Accessories	
Spike	With PVC spike as spike spot lights (Standard)
Round base	With SS304 round base for wall mounting (optional)
Packaging	
Inner box size	140*115*80mm
Carton size	39.5*28*26cm (18PCS / carton)

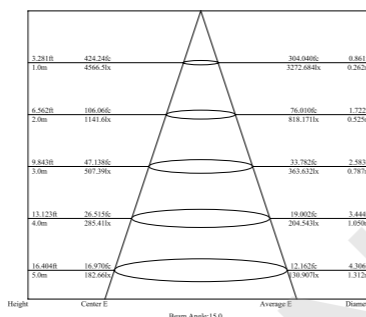


Dimension

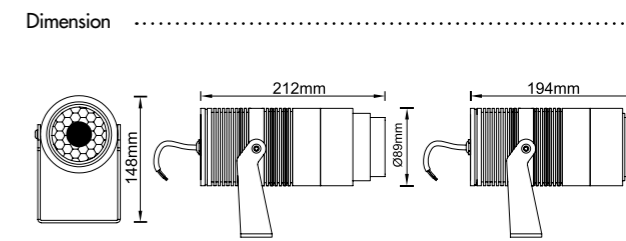
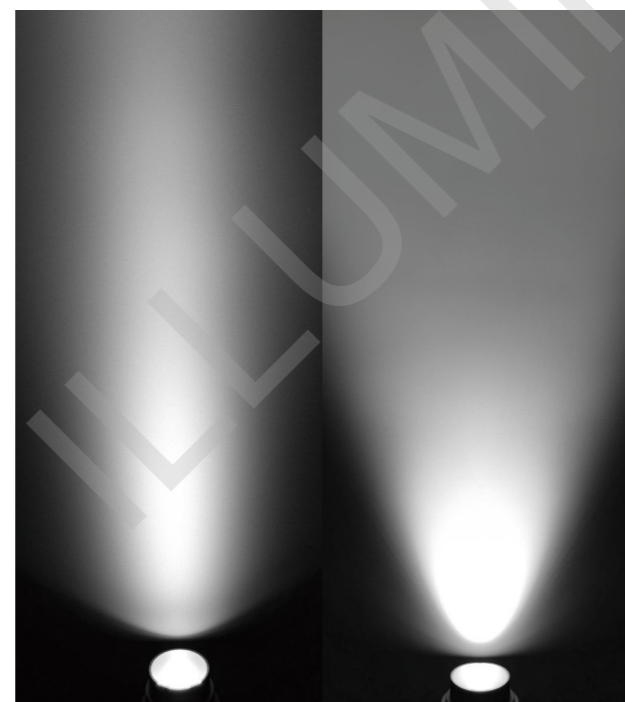
Light Distribution Curve (3000K, 10°)



Lux distance Curve (3000K, 10°)

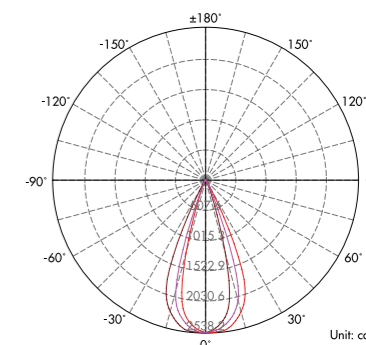


Illumination Picture (10°/40°)

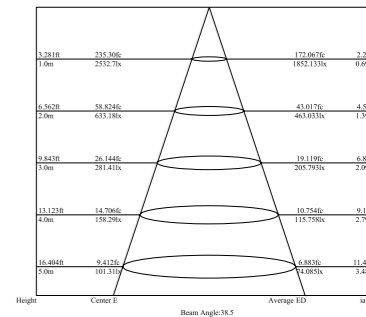


Dimension

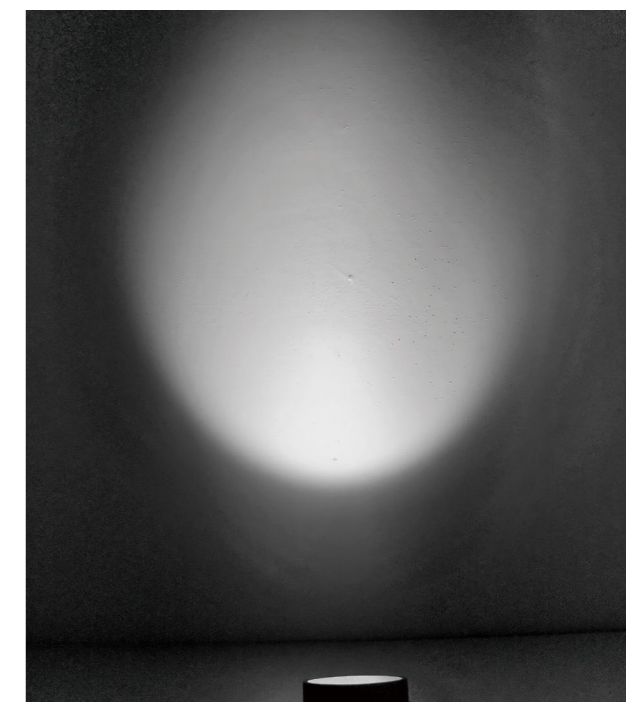
Light Distribution Curve (3000K, 40°)



Lux distance Curve (3000K, 40°)



Illumination Picture (40°)



CE RoHS COMPLIANT IP67 IK04

1 Year Warranty

Parameter

General Data	
Item No.	UL-18W-COB-1800FH(PULL)
Power	18 Watts ± 10%
LED type	1 PC 18W TOYONIA COB LED
Luminous flux	10°: 500lm ± 10%; 40°: 800lm ± 10%
CCT	2700K, 3000K, 4000K, 6000K
CRI	80+
Beam angle	Zoomable 10° to 40°
Dimension	163*117*75 (mm) (Length x height x Diameter)
Cut out	/ mm
Net weight	1.2 kgs
Warranty	1 year
Certifications	CE, RoHS
Electrical Data	
Input voltage	AC100-265V or DC24V
Insulation class	Class I or III
Cable	1PC rubber cable 1M HO5RNF 3 or 2 x 1mm square
Driver	AC100-265V: built-in constant current driver DC24V: constant low voltage input, constant current output for LEDs
Construction Data	
IP rating	IP67 Waterproof
IK rating	IK04
Housing	Solid Passivated (Anodizing) Aluminum CNC machined
Protection finishing	anodizing + powder coated painting in dark grey as standard, black or white as options
Trim	Aluminum
Glass	Tempered glass T=2mm
Loading capacity	220 kgs
Cable Gland	PG gland
Gasket	silicone ring + silicone glue seal
Accessories	
Spike	with 205mm height Aluminium spike for ground installation with SS304 Pedal that can be used with spike for pushing the spike light into the ground by foot
Pedal	light into the ground by foot
Round base	With SS304 base in dark grey as optional for concrete ground installation
Packaging	
Inner box size	230*130*85 mm
Carton size	48*28*19.5 cm (12 PCS / carton)

CE RoHS COMPLIANT IP67 IK04

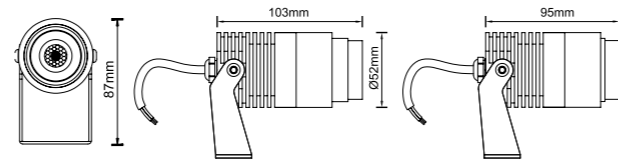
1 Year Warranty

Parameter

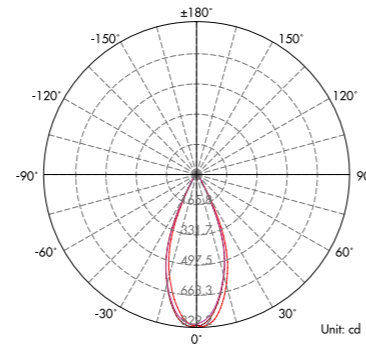
General Data	
Item No.	UL-25W-COB-2500FH(PULL)
Power	25 Watts +10%
LED type	1 PC 25W CREE COB CMA1516 LED or TOYONIA COB LED M20
Luminous flux	10°: 750 lm±10%; 40°: 1250 lm±10%
CCT	2700K, 3000K, 4000K, 6000K
CRI	80+
Beam angle	Zoomable 10° to 40° adjustable
Dimension	Ø89 x 212 (mm) Diameter x length
Cut out	/
Net weight	1.72 kgs
Warranty	1 year
Certifications	CE, RoHS
Electrical Data	
Input voltage	AC100-265V
Insulation class	Class I
Cable	1PC rubber cable 1M HO5RNF 3x1mm square
Driver	High voltage constant current output, with the transformer
Construction Data	
IP rating	IP67 Waterproof
IK rating	IK04
Housing	Solid Passivated (Anodizing) Aluminum CNC machined
Protection finishing	anodizing + powder coated painting in dark grey as standard, black or white as options
Trim	Passivated (Anodizing) Aluminum
Glass	Tempered Glass. T=2mm.
Loading capacity	220 kgs
Cable Gland	PG gland
Gasket	O-ring PMQ silicone seal
Accessories	
Spike	With Aluminium spike optional
Round base	With SS304 round base optional
Packaging	
Inner box size	250*155*110 mm
Carton size	49*27*24 cm (6 PCS / carton)



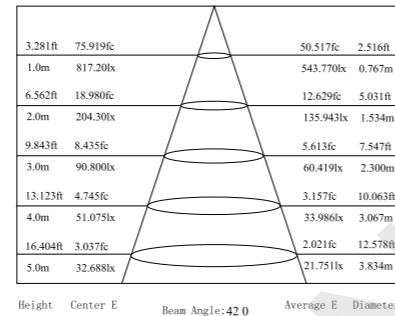
Dimension



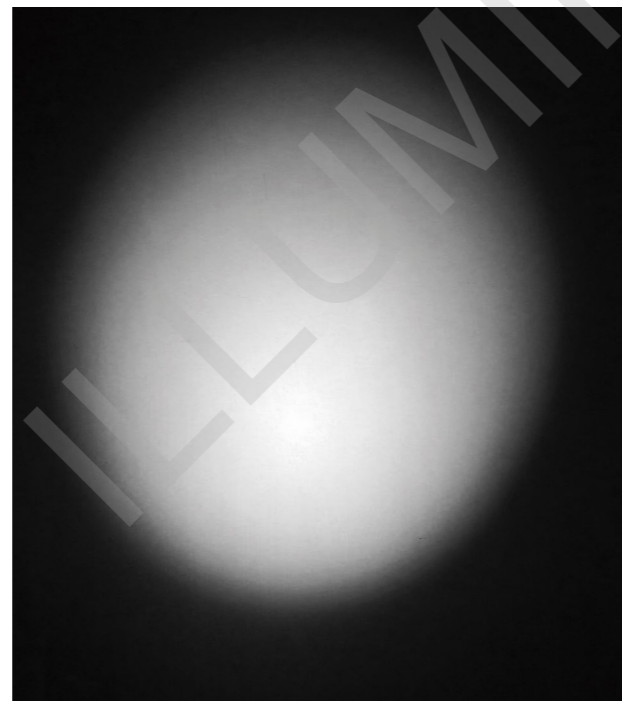
Light Distribution Curve (3000K, 40°)



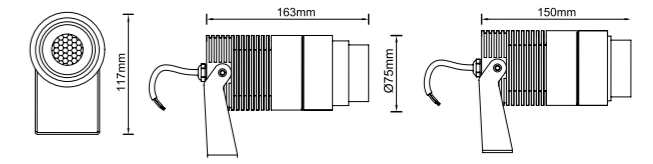
Lux distance Curve (3000K, 40°)



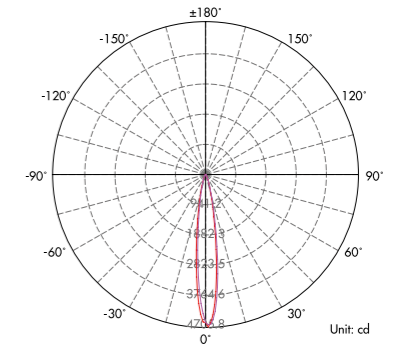
Illumination Picture (40°)



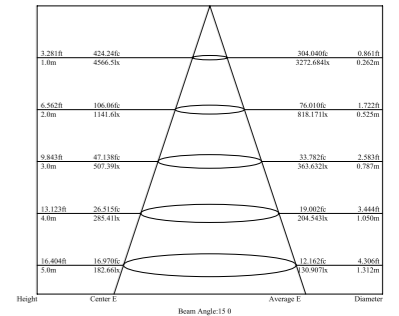
Dimension



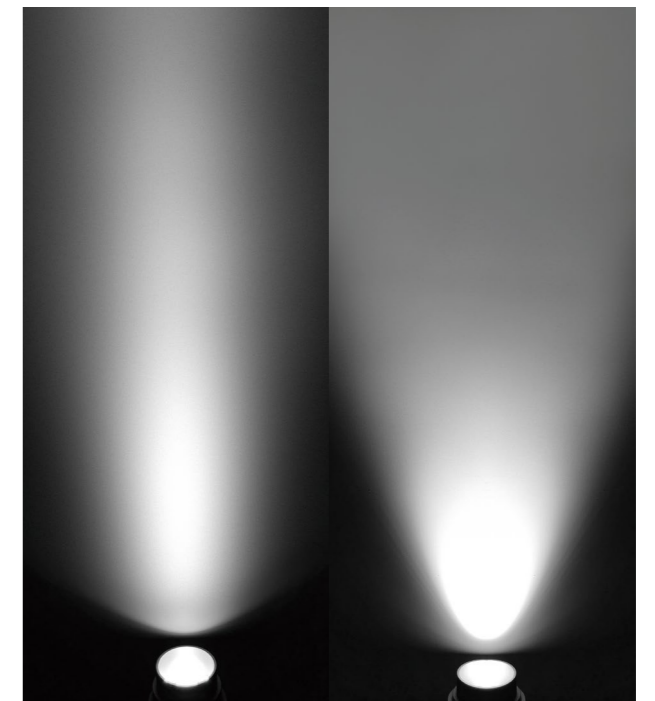
Light Distribution Curve (3000K, 10°)



Lux distance Curve (3000K, 10°)



Illumination Picture (10°/40°)



CE RoHS COMPLIANT IP67 IK04

Passivated Zoomable

1 Year Warranty

Parameter

General Data	
Item No.	UL-8W-COB-0800FH (ROTATE)
Power	8 watts ±10%
LED type	1 PC 8W TOYONIA COB LED
Luminous flux	10°:200~250, 40°:360~400 lm
CCT	2700K, 3000K, 4000K, 6000K
CRI	80+
Beam angle	Zoomable 10° to 40° adjustable
Dimension	52 x 103 (mm) Diameter x Height
Cut out	/
Net weight	0.46 kgs
Warranty	1 year
Certifications	CE, RoHS
Electrical Data	
Input voltage	AC100~245V as standard (DC24V as options)
Insulation class	Class I
Cable	1PC rubber cable 1M H05RN-F 3x1mm square
Driver	Built-in high voltage constant current driver with transformer
Construction Data	
IP rating	IP67 Waterproof
IK rating	IK04
Housing	Solid Passivated (Anodizing) Aluminum CNC machined
anodizing + powder coated painting in dark grey as standard, black or white as options	
Trim	Passivated (Anodizing) Aluminum
Glass	Step tempered Glass, T=2mm
Loading capacity	220 kgs
Cable Gland	PG7 IP67
Gasket	O-ring PMQ silicone seal
Accessories	
Spike	With black PVC spike as standard
Round base	With SS304 round base as optional
Packaging	
Inner box size	180*105*65 mm
Carton size	55*23.5*14 cm (20 PCS / carton)

CE RoHS COMPLIANT IP67 IK04

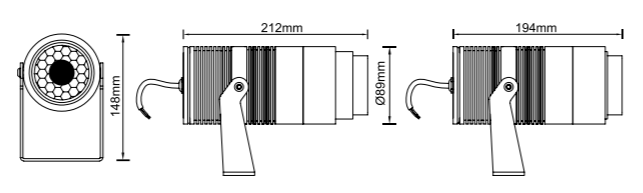
1 Year Warranty

Parameter

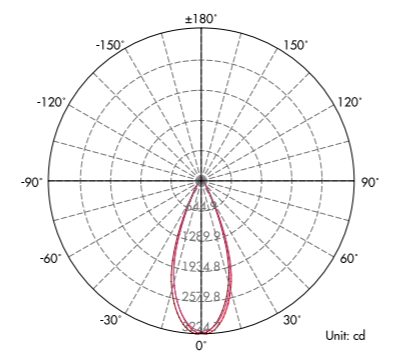
General Data	
Item No.	UL-18W-COB-1800FH (ROTATE)
Power	18 Watts ± 10%
LED type	1 PC 18W TOYONIA COB LED
Luminous flux	10°: 500LM ± 10%; 40°: 800LM ± 10%
CCT	2700K, 3000K, 4000K, 6000K
CRI	80+
Beam angle	Zoomable 10° to 40°
Dimension	163*117*75 (mm) (Length x height x Diameter)
Cut out	/ mm
Net weight	1.2 kgs
Warranty	1 year
Certifications	CE, RoHS
Electrical Data	
Input voltage	AC100-265V or DC24V
Insulation class	Class I or III
Cable	1PC rubber cable 1M H05RN-F 3 or 2 x 1mm square
Driver	AC100-265V: built-in constant current driver DC24V: constant low voltage input, constant current output for LEDs
Construction Data	
IP rating	IP67 Waterproof
IK rating	IK04
Housing	Solid Passivated (Anodizing) Aluminum CNC machined
anodizing + powder coated painting in dark grey as standard, black or white as options	
Trim	Aluminum
Glass	Tempered glass T=2mm
Loading capacity	220 kgs
Cable Gland	PG gland
Gasket	silicone ring + silicone glue seal
Accessories	
Spike	with 205mm height Aluminium spike for ground installation with SS304 Pedal that can be used with spike for pushing the spike light into the ground by foot
Pedal	With SS304 base in dark grey as optional for concrete ground installation
Packaging	
Inner box size	230*130*85 mm
Carton size	48*28*19.5 cm (12 PCS / carton)



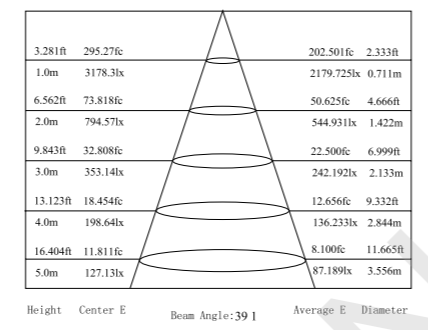
Dimension



Light Distribution Curve (3000K, 40°)



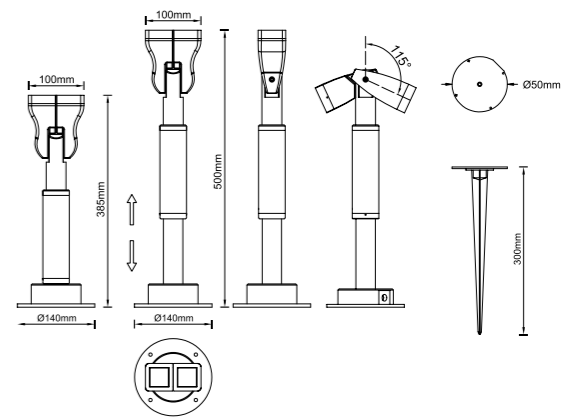
Lux distance Curve (3000K, 40°)



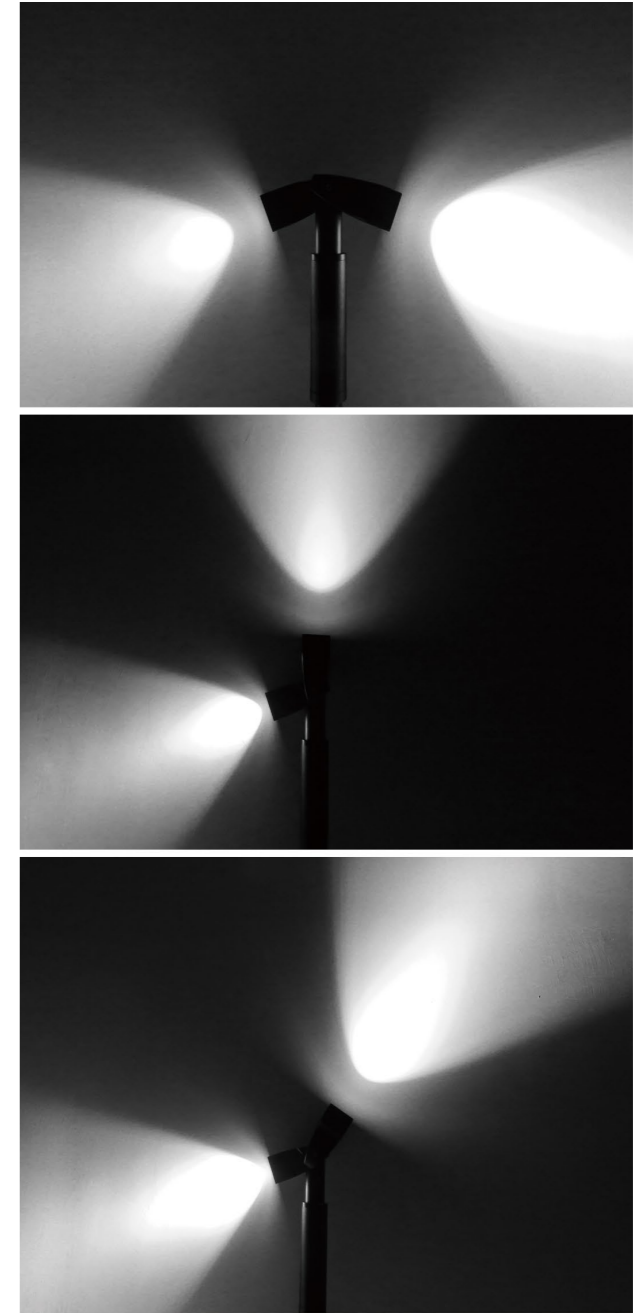
Illumination Picture (40°)



Dimension



Illumination Picture (25°)



CE RoHS COMPLIANT IP67 IK04

Passivated Zoomable 1 Year Warranty

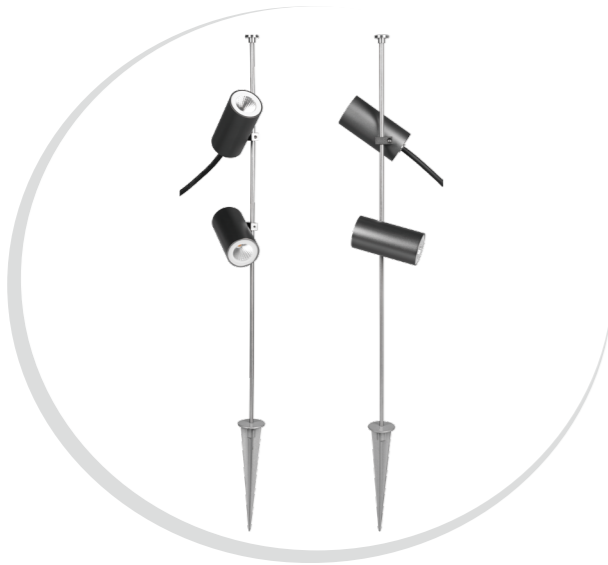
Parameter	
General Data	
Item No.	UL-25W-COB-2500FH (ROTATE)
Power	25 watts ±10%
LED type	1 PC 25W CREE COB CMA1516 LED or TOYONIA COB LED M20
Luminous flux	10°: 750 lm±10%; 40°: 1250 lm±10%
CCT	2700K, 3000K, 4000K, 6000K
CRI	80+
Beam angle	Zoomable 10° to 40° adjustable
Dimension	89 x 212 (mm) Diameter x Height
Cut out	/
Net weight	1.68 kgs
Warranty	1 year
Certifications	CE, RoHS
Electrical Data	
Input voltage	AC100-265V
Insulation class	Class I
Cable	1PC rubber cable 1M H05RN-F 3x1mm square
Driver	Built-in high voltage constant current driver with transformer
Construction Data	
IP rating	IP67 Waterproof
IK rating	IK04
Housing	Solid Passivated (Anodizing) Aluminum CNC machined
Protection finishing	anodizing + powder coated painting in dark grey as standard, black or white as options
Trim	Passivated (Anodizing) Aluminum
Glass	Step tempered Glass. T=2mm.
Loading capacity	220 kgs
Cable Gland	PG7 IP67
Gasket	O-ring PMQ silicone seal
Accessories	
Spike	With black Aluminium spike as standard
Round base	With SS304 round base as optional
Packaging	
Inner box size	250*155*110 mm
Carton size	49*27*24 cm (6 PCS / carton)

CE RoHS COMPLIANT IP65 IK04

Passivated 1 Year Warranty

Parameter	
General Data	
Item No.	UL-1018-1500-A
Power	15 Watts
LED type	2 PCS 7.5W CREE CXA1304 COB LED
Luminous flux	750~800 lm
CCT	2700K, 3000K, 4000K, 6000K
CRI	80+
Beam angle	15°, 25°
Dimension	140 x 385 to 500 (mm) adjustable Diameter x Height
Cut out	/
Net weight	2.8 kgs
Warranty	1 year
Certifications	CE, RoHS
Electrical Data	
Input voltage	AC100-265V
Insulation class	Class I
Cable	1PC rubber cable 0.5M H05RN-F 3x0.75mm square
Driver	Built-in high voltage constant current driver with transformer
Construction Data	
IP rating	IP65 Waterproof
IK rating	IK04
Housing	Solid Passivated (Anodizing) Aluminum CNC machined
Protection finishing	anodizing + powder coated painting in dark grey as standard, black or white as options
Trim	Passivated (Anodizing) Aluminum
Glass	Step tempered Glass. T=3mm.
Loading capacity	120 kgs
Cable Gland	IP65 Aluminium part
Gasket	PMQ silicone seal
Accessories	
Spike	With Aluminium spike
Round base	With round base and screws
Packaging	
Inner box size	430*180*160 mm
Carton size	43*18*16 cm (1PC / Carton)

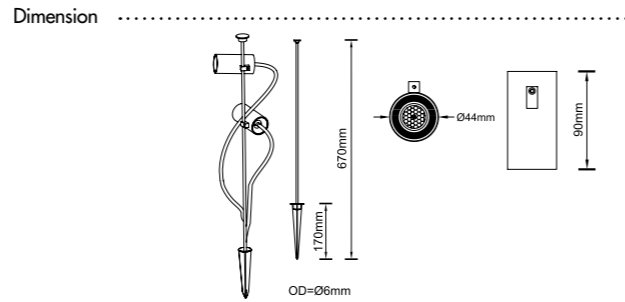




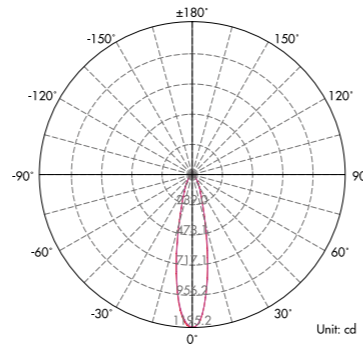
CE RoHS COMPLIANT IP65 IK04

Passivated 1 Year Warranty

Parameter	
General Data	
Item No.	UL-1010-0500EH
Power	5 watts
LED type	1 PC 5W CREE COB LED
Luminous flux	350~400 lm
CCT	2700K, 3000K, 4000K, 6000K
CRI	80+
Beam angle	15°, 24°
Dimension	44 x 90 (mm) Diameter x Height
Cut out	/
Net weight	0.3 kgs
Warranty	1 year
Certifications	CE, RoHS
Electrical Data	
Input voltage	AC 100-265V as standard (DC 12V or DC 24V as optional)
Insulation class	Class I
Cable	1PC rubber cable 1M H05RN-F 3x1mm square
Driver	Built-in high voltage constant current driver with transformer
Construction Data	
IP rating	IP65 Waterproof
IK rating	IK04
Housing	Solid Passivated (Anodizing) Aluminum CNC machined anodizing + powder coated painting in dark grey as standard, black or white as options
Protection finishing	
Trim	Passivated (Anodizing) Aluminum
Glass	Step tempered Glass. T=3mm.
Loading capacity	220 kgs
Cable Gland	PG7 IP67
Gasket	O-ring PMQ silicone seal
Accessories	
Spike	With 500mm stainless steel 304 stake +170mm Aluminium spike
Packaging	
Inner box size	116*95*48 mm
Carton size	49*25*16 cm (30 PCS / carton)



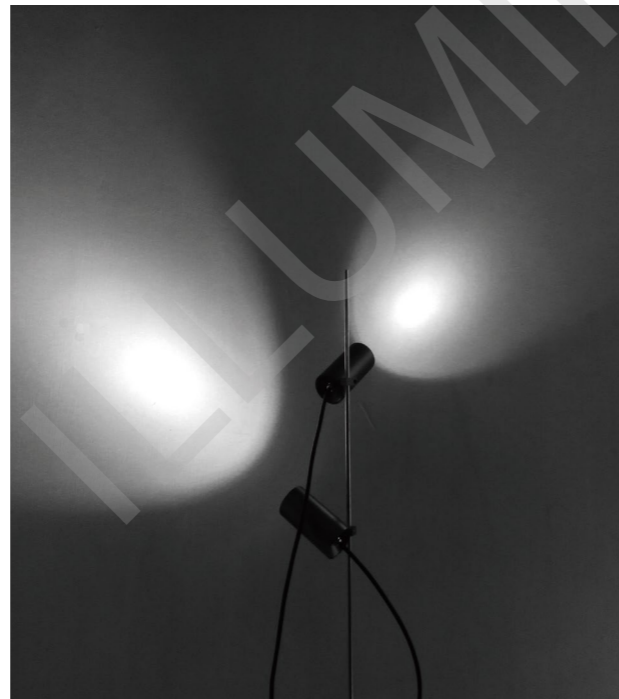
Light Distribution Curve (3000K, 24°)



Lux distance Curve (3000K, 24°)

Height	Center E	Beam Angle: 22.6	Average E	Diameter
3.281ft	111.04ft		78.030fc	1.309ft
1.0m	1195.2lx		839.918lx	0.399m
6.562ft	27.759fc		19.508fc	2.618ft
2.0m	298.80lx		209.980lx	0.798m
9.843ft	12.337fc		8.670fc	3.928ft
3.0m	132.80lx		93.324lx	1.197m
13.123ft	6.940fc		4.877fc	5.237ft
4.0m	74.700lx		52.495lx	1.596m
16.404ft	4.441fc		3.121fc	6.546ft
5.0m	47.808lx		33.597lx	1.995m

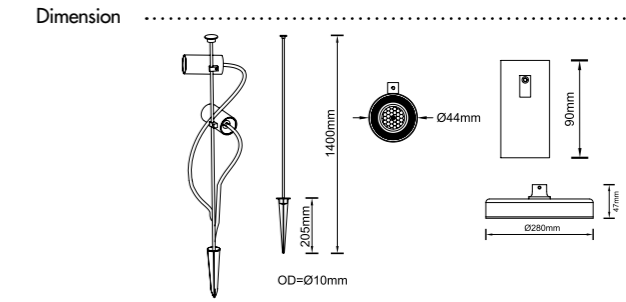
Illumination Picture (24°)



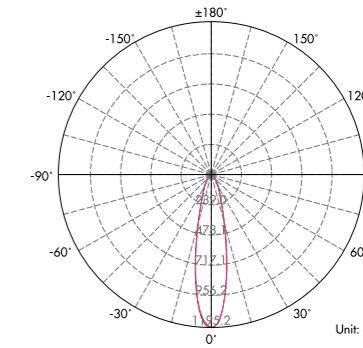
CE RoHS COMPLIANT IP65 IK04

Passivated 1 Year Warranty

Parameter	
General Data	
Item No.	UL-1010-0500EH (LF08)
Power	5 watts
LED type	1 PC 5W CREE COB LED
Luminous flux	350~400 lm
CCT	2700K, 3000K, 4000K, 6000K
CRI	80+
Beam angle	15°, 24°
Dimension	44 x 90 (mm) Diameter x Height
Cut out	/
Net weight	0.3 kgs
Warranty	1 year
Certifications	CE, RoHS
Electrical Data	
Input voltage	AC 100-265V as standard (DC 12V or DC 24V as optional)
Insulation class	Class I
Cable	1PC rubber cable 1M or 2M H05RN-F 3x1mm square
Driver	Built-in high voltage constant current driver with transformer
Construction Data	
IP rating	IP65 Waterproof
IK rating	IK04
Housing	Solid Passivated (Anodizing) Aluminum CNC machined anodizing + powder coated painting in dark grey as standard, black or white as options
Protection finishing	
Trim	Passivated (Anodizing) Aluminum
Glass	Step tempered Glass. T=3mm.
Loading capacity	220 kgs
Cable Gland	PG7 IP67
Gasket	O-ring PMQ silicone seal
Accessories	
Spike	With 1200mm stainless steel 304 stick +205mm Aluminium spike optional
Round base	Round base for surface mounting as options
Packaging	
Inner box size	116*95*48 mm
Carton size	49*25*16 cm (30 PCS / carton)



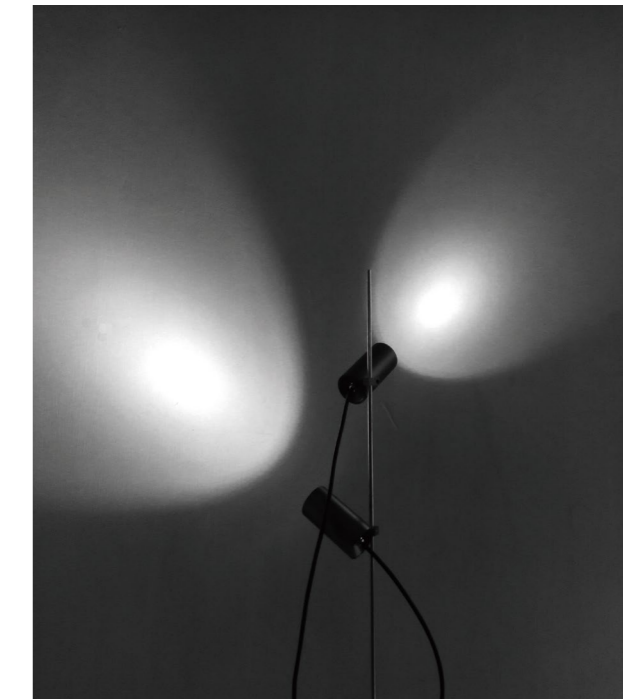
Light Distribution Curve (3000K, 24°)



Lux distance Curve (3000K, 24°)

Height	Center E	Beam Angle: 22.6	Average E	Diameter
3.281ft	111.04ft		78.030fc	1.309ft
1.0m	1195.2lx		839.918lx	0.399m
6.562ft	27.759fc		19.508fc	2.618ft
2.0m	298.80lx		209.980lx	0.798m
9.843ft	12.337fc		8.670fc	3.928ft
3.0m	132.80lx		93.324lx	1.197m
13.123ft	6.940fc		4.877fc	5.237ft
4.0m	74.700lx		52.495lx	1.596m
16.404ft	4.441fc		3.121fc	6.546ft
5.0m	47.808lx		33.597lx	1.995m

Illumination Picture (24°)



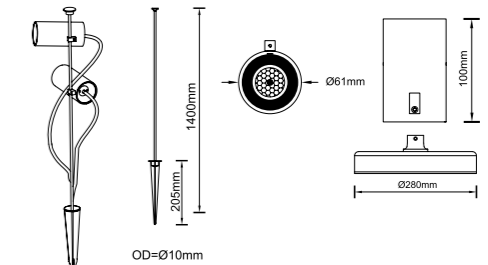


CE RoHS COMPLIANT IP65 IK04

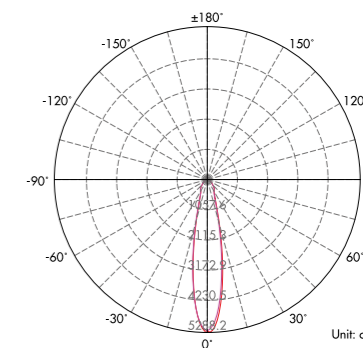
Passivated 1 Year Warranty

Parameter	
General Data	
Item No.	UL-15W-COB-1 200-EH
Power	12 watts ± 10%
LED type	1 PC 12W CREE COB LED
Luminous flux	1200 lm
CCT	2700K, 3000K, 4000K, 6000K
CRI	80+
Beam angle	15°, 23°, 38°, 45°, 60°
Dimension	61 x 100 (mm) Diameter x Height
Cut out	/
Net weight	0.55 kgs
Warranty	1 year
Certifications	CE, RoHS
Electrical Data	
Input voltage	AC 100-265V as standard (DC 24V as optional)
Insulation class	Class I
Cable	1PC rubber cable 1M or 2M H05RN-F 3x1mm square
Driver	Built-in high voltage constant current driver with transformer
Construction Data	
IP rating	IP65 Waterproof
IK rating	IK04
Housing	Solid Passivated (Anodizing) Aluminum CNC machined
Protection finishing	anodizing + powder coated painting in dark grey as standard, black or white as options
Trim	Passivated (Anodizing) Aluminum
Glass	Step tempered Glass. T=3mm.
Loading capacity	220 kgs
Cable Gland	PG7 IP67
Gasket	O-ring PMQ silicone seal
Accessories	
Spike	With 1200mm stainless steel 304 stick +205mm Aluminium spike optional
Round base	Round base for surface mounting as options
Packaging	
Inner box size	130*115*80 mm
Carton size	36.5*28*26 cm (18 PCS / carton)

Dimension



Light Distribution Curve (3000K, 23°)



Lux distance Curve (3000K, 23°)

Height	Center E	Beam Angle: 21.4	Average E	Diameter
3.281ft	486.43fc	338.197fc	1.240ft	
1.0m	5236.0lx	3640.348lx	0.378m	
6.562ft	121.61fc	84.549fc	2.479ft	
2.0m	1309.0lx	910.087lx	0.756m	
9.843ft	54.048fc	37.577fc	3.719ft	
3.0m	581.77lx	404.483lx	1.134m	
13.123ft	30.402fc	21.137fc	4.959ft	
4.0m	327.25lx	227.522lx	1.511m	
16.404ft	19.457fc	13.528fc	6.198ft	
5.0m	209.44lx	145.614lx	1.889m	

Illumination Picture (23°)





CE RoHS COMPLIANT IP67 IK04

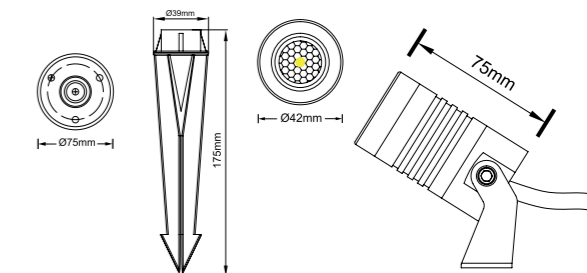
Passivated 1 Year Warranty

RGB

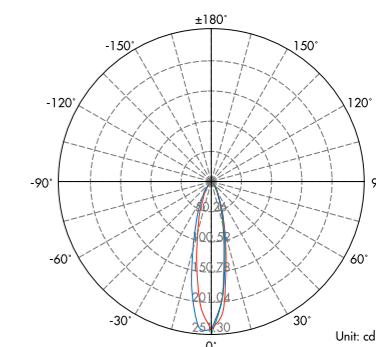
Parameter

General Data	
Item No.	UL-1010-0600-RGB-A
Power	6 Watts
LED type	1 PC 6W RGB SMD5050 LED
Luminous flux	200 lm (ALL RGB LEDS ON)
CCT	RGB
CRI	70+
Beam angle	25° (Optional 38°)
Dimension	42 x 75 (mm) Diameter x Height
Cut out	/
Net weight	0.38 kgs
Warranty	1 year
Certifications	CE, RoHS
Electrical Data	
Input voltage	DC 12V
Insulation class	Class III
Cable	1PC rubber cable 1.5M H05RN-F 4x0.75mm square
Driver	low voltage constant current output, excluding the transformer
Construction Data	
IP rating	IP67 Waterproof
IK rating	IK04
Housing	Solid Passivated (Anodizing) Aluminum CNC machined anodizing + powder coated painting in dark grey as standard, black or white as options
Protection finishing	
Trim	Passivated (Anodizing) Aluminum
Glass	Step tempered Glass. T=3mm.
Loading capacity	220 kgs
Cable Gland	PG9 IP67
Gasket	O-ring PMQ silicone seal
Accessories	
Spike	116*95*48 mm
Round base	49*25*16 cm (30 PCS / carton)
Packaging	
Inner box size	95*65*65 mm
Carton size	40*34.5*28 cm (80PCS / carton)

Dimension



Light Distribution Curve (3000K, 2x80°)

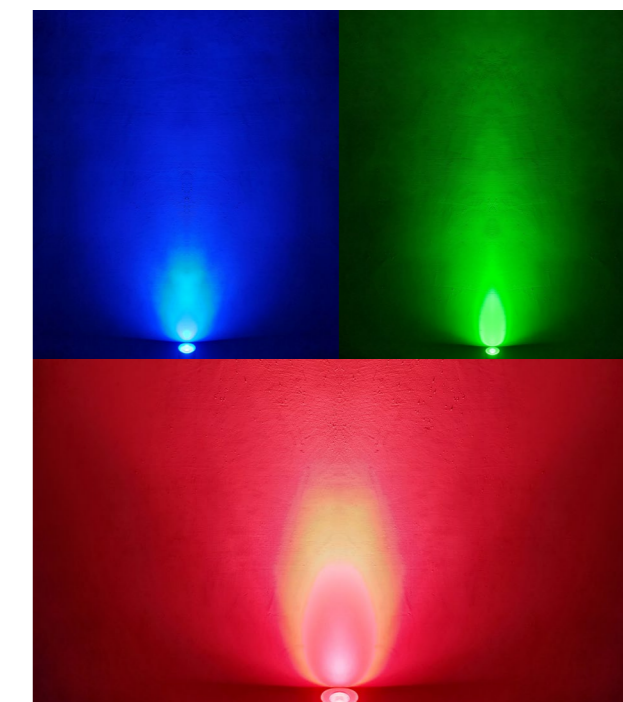


Lux distance Curve (RGB, 25°)

	Illuminance at a Distance	
	Center Beam LUX	Beam Width V H
2m	60.71 LUX	0.8m 0.9m
4m	15.18 LUX	1.7m 1.8m
6m	6.75 LUX	2.5m 2.7m
8m	3.79 LUX	3.3m 3.6m
10m	2.43 LUX	4.2m 4.5m
12m	1.69 LUX	5.0m 5.4m

Vert.Spread:23.5 Horiz.Spread:25.3

Illumination Picture (25°)





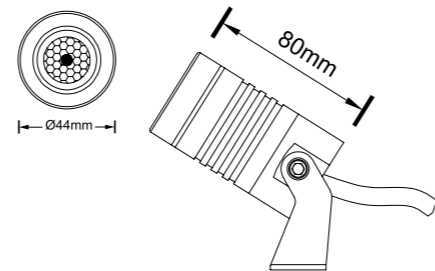
CE RoHS COMPLIANT IP67 IK04

Passivated 1 Year Warranty

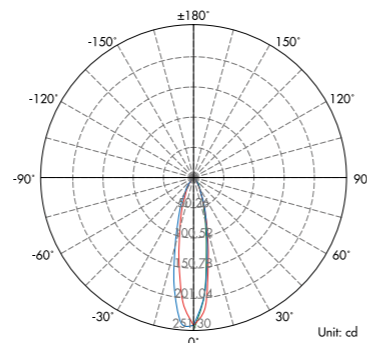
RGBW

Parameter	
General Data	
Item No.	UL-1010-0500 (RGBW)A
Power	5 Watts
LED type	1 PC 5W RGBW5500K 4in1 COB LED
Luminous flux	/
CCT	RGBW5500K
CRI	/
Beam angle	10°, 23°, 38°
Dimension	44 x 80 (mm) Diameter x Height
Cut out	/
Net weight	0.4 kgs
Warranty	1 year
Certifications	CE, RoHS
Electrical Data	
Input voltage	DC12V
Insulation class	Class III
Cable	1PC rubber cable 1.5M H05RN-F 5x0.5mm square
Driver	Low voltage constant current output, excluding the transformer
Construction Data	
IP rating	IP67 Waterproof
IK rating	IK04
Housing	Solid Passivated (Anodizing) Aluminum CNC machined
Protection finishing	anodizing + powder coated painting in dark grey as standard, black or white as options
Trim	Passivated (Anodizing) Aluminum
Glass	Step tempered Glass. T=2mm.
Loading capacity	220 kgs
Cable Gland	PG9 IP67
Gasket	O-ring PMQ silicone seal
Accessories	
Spike	With PVC spike as spike spot lights (Standard)
Round base	With SS304 round base for wall mounting (optional)
Packaging	
Inner box size	116*95*48 mm
Carton size	49*25*16 cm (30 PCS / carton)

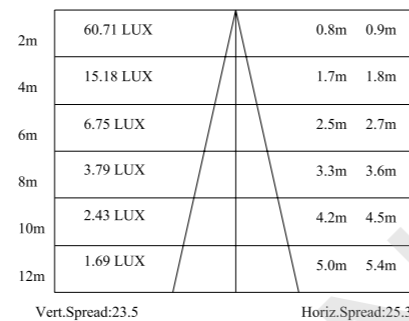
Dimension



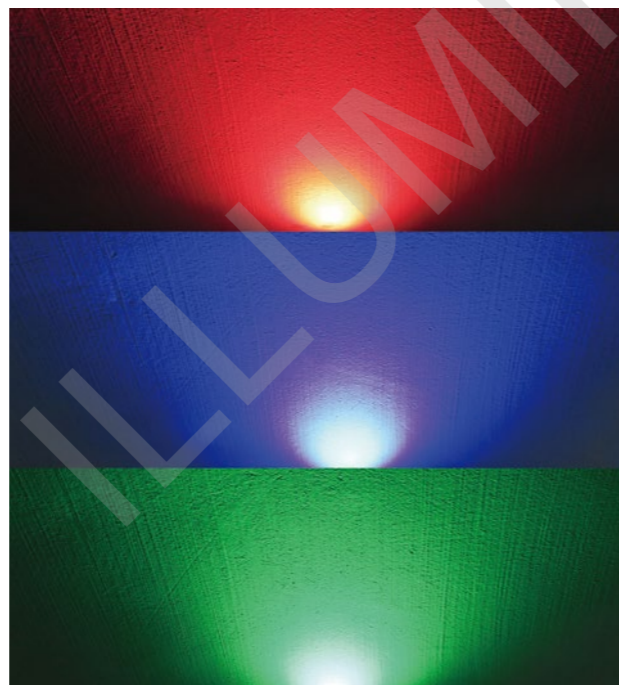
Light Distribution Curve (RGBW5500K, 23°)



Lux distance Curve (RGBW5500K, 23°)



Illumination Picture (23°)



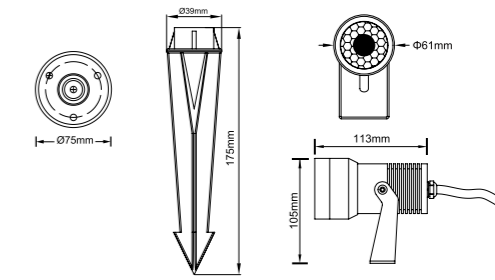
CE RoHS COMPLIANT IP67 IK04

Passivated 1 Year Warranty

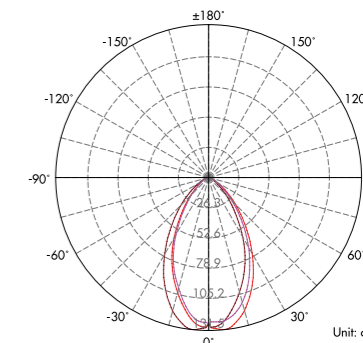
RGBW

Parameter	
General Data	
Item No.	UL-1012-1200 (RGBW)A
Power	12 Watts
LED type	3PCS 4W RGBW 3030 LED
Luminous flux	/
CCT	RGB+WVV3000K (RGB+4500K or RGB+6000K as options)
CRI	70+
Beam angle	10°, 23°, 36°
Dimension	61 x 113 (mm) Diameter x Height
Cut out	/
Net weight	0.52 kgs
Warranty	1 year
Certifications	CE, RoHS
Electrical Data	
Input voltage	DC12V
Insulation class	Class III
Cable	1PC rubber cable 1.5M H05RN-F 5x0.75mm square
Driver	Low voltage constant current output, excluding the transformer
Construction Data	
IP rating	IP67 Waterproof
IK rating	IK04
Housing	Solid Passivated (Anodizing) Aluminum CNC machined
Protection finishing	anodizing + powder coated painting in dark grey as standard, black or white as options
Trim	Passivated (Anodizing) Aluminum
Glass	Tempered frosted glass. T=3mm
Loading capacity	220 kgs
Cable Gland	PG9 IP67
Gasket	O-ring PMQ silicone seal
Accessories	
Spike	With PVC spike as spike spot lights (Standard)
Round base	With SS304 round base for wall mounting (optional)
Packaging	
Inner box size	130*115*80mm
Carton size	36.5*28*26cm (18PCS / carton)

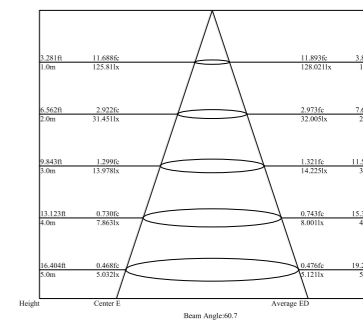
Dimension



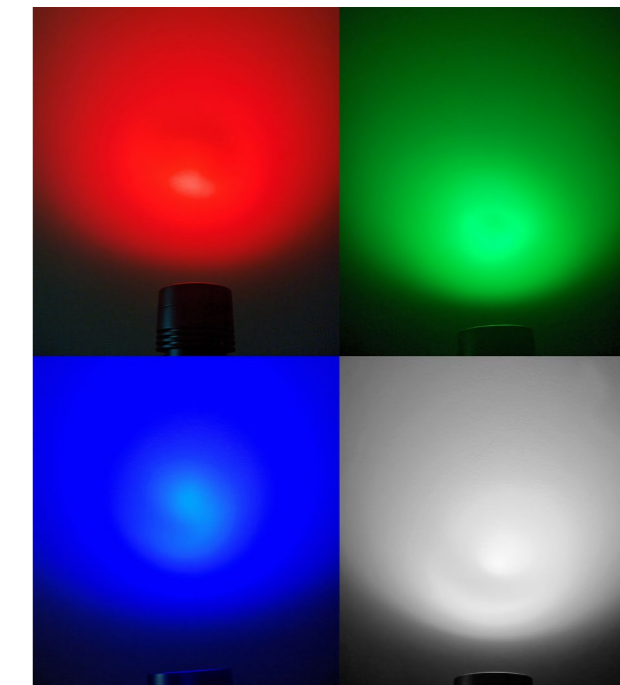
Light Distribution Curve (RGB+CW6000K, 30°)



Lux distance Curve (RGB+CW6000K, 30°)

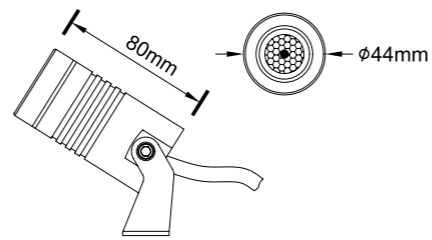


Illumination Picture (30°)

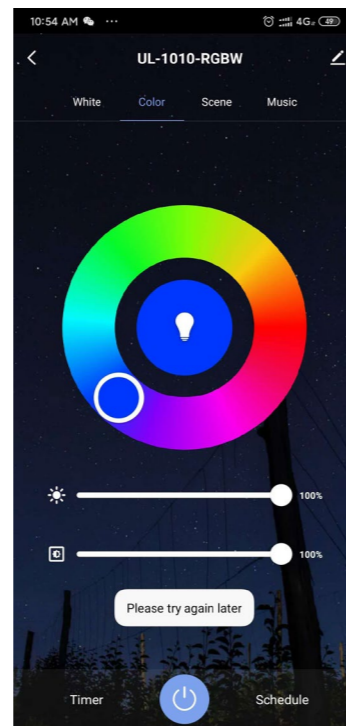




Dimension



Wi-Fi Control



Illumination Picture (24°)



CE RoHS COMPLIANT IP67 IK04
Passivated 1 Year Warranty
RGBW

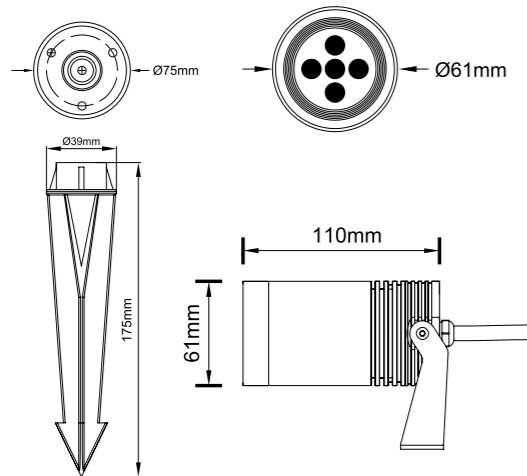
Parameter

General Data	
Item No.	UL-1010-05000(RGBW)-B(WIFI)
Power	5 Watts +10%
LED type	1 PC RGBW 4in1 3030 LED
Luminous flux	/
CCT	RGBW5500K or RGBW3000K or RGBW4500K
CRI	/
Beam angle	15°, 24°, 36°, 60°
Dimension	Ø44x80 (mm) Diameter x length
Cut out	/ mm
Net weight	0.4 kgs
Warranty	1 year
Certifications	CE, RoHS
Electrical Data	
Input voltage	DC 12V
Insulation class	Class III
Cable	1PC rubber cable 1.5M H05RN-F 5x0.5mm square
Driver	Low voltage constant voltage input , constant current output for LED
Control	WiFi control by Tuya systems in mobile phone
Construction Data	
IP rating	IP67 Waterproof
IK rating	IK04
Housing	Solid Passivated (Anodizing) Aluminum CNC machined
Protection finishing	anodizing + powder coated painting in dark grey as standard, black or white as options
Trim	Aluminium
Glass	Tempered Glass
Loading capacity	/
Cable Gland	PG gland
Gasket	silicone ring + silicone glue seal
Accessories	
Spike	With PVC spike as spike spot lights (Standard)
Round base	With SS304 round base for wall mounting (optional)
Packaging	
Inner box size	116*95*48 mm
Carton size	49*25*16 cm (30 PCS / carton)

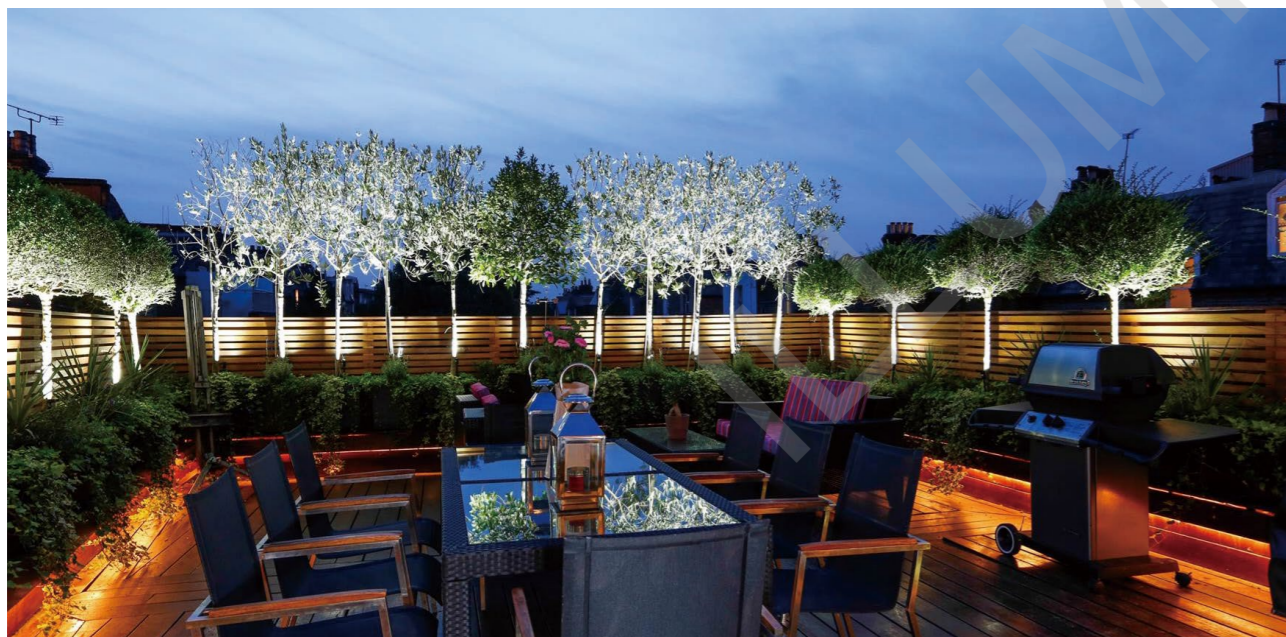


Parameter	
General Data	
Item No.	UL-1012-GU10A-70
Power	/
LED type	Without GU10 lamp as standard, with GU10 lamp as options.
Luminous flux	for fitting GU10 lamp with totally height 70mm at max (including pins)
CCT	/
CRI	/
Beam angle	/
Dimension	61 x 110 (mm) Diameter x Height
Cut out	/
Net weight	0.53 kgs
Warranty	1 year
Certifications	CE, RoHS
Electrical Data	
Input voltage	AC 90~265V
Insulation class	Class I
Cable	1PC rubber cable 1M H05RN-F 3x1mm square
Driver	/
Construction Data	
IP rating	IP67 Waterproof
IK rating	IK04
Housing	Solid Passivated (Anodizing) Aluminum CNC machined
Protection finishing	anodizing + powder coated painting in dark grey as standard, black or white as options
Trim	Passivated (Anodizing) Aluminum
Glass	Step tempered Glass, T=3mm.
Loading capacity	220 kgs
Cable Gland	PG7 IP67
Gasket	O-ring PMQ silicone seal
Accessories	
Spike	With PVC spike as spike spot lights (Standard)
Round base	With SS304 round base for wall mounting (optional)
Packaging	
Inner box size	130*115*80 mm
Carton size	36.5*28*26cm (18PCS each carton)

Dimension

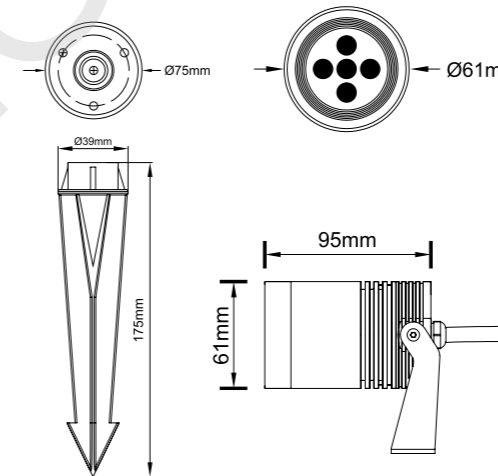


Application Picture



Parameter	
General Data	
Item No.	UL-1012-GU10A
Power	/
LED type	Without GU10 lamp as standard, with GU10 lamp as options.
Luminous flux	for fitting GU10 lamp with totally height 54mm at max (including pins)
CCT	/
CRI	/
Beam angle	/
Dimension	61 x 95 (mm) Diameter x Height
Cut out	/
Net weight	0.48 kgs
Warranty	1 year
Certifications	CE, RoHS
Electrical Data	
Input voltage	AC 90~265V
Insulation class	Class I
Cable	1PC rubber cable 1M H05RN-F 3x1mm square
Driver	/
Construction Data	
IP rating	IP67 Waterproof
IK rating	IK04
Housing	Solid Passivated (Anodizing) Aluminum CNC machined
Protection finishing	anodizing + powder coated painting in dark grey as standard, black or white as options
Trim	Passivated (Anodizing) Aluminum
Glass	Step tempered Glass, T=3mm.
Loading capacity	220 kgs
Cable Gland	PG7 IP67
Gasket	O-ring PMQ silicone seal
Accessories	
Spike	With PVC spike as spike spot lights (Standard)
Round base	With SS304 round base for wall mounting (optional)
Packaging	
Inner box size	130*115*80 mm
Carton size	36.5*28*26cm (18PCS each carton)

Dimension



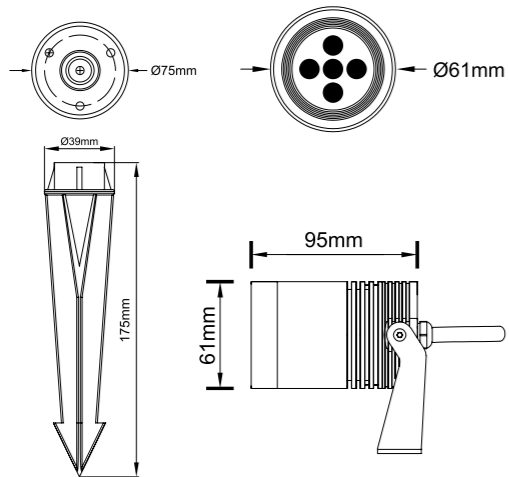
Application Picture





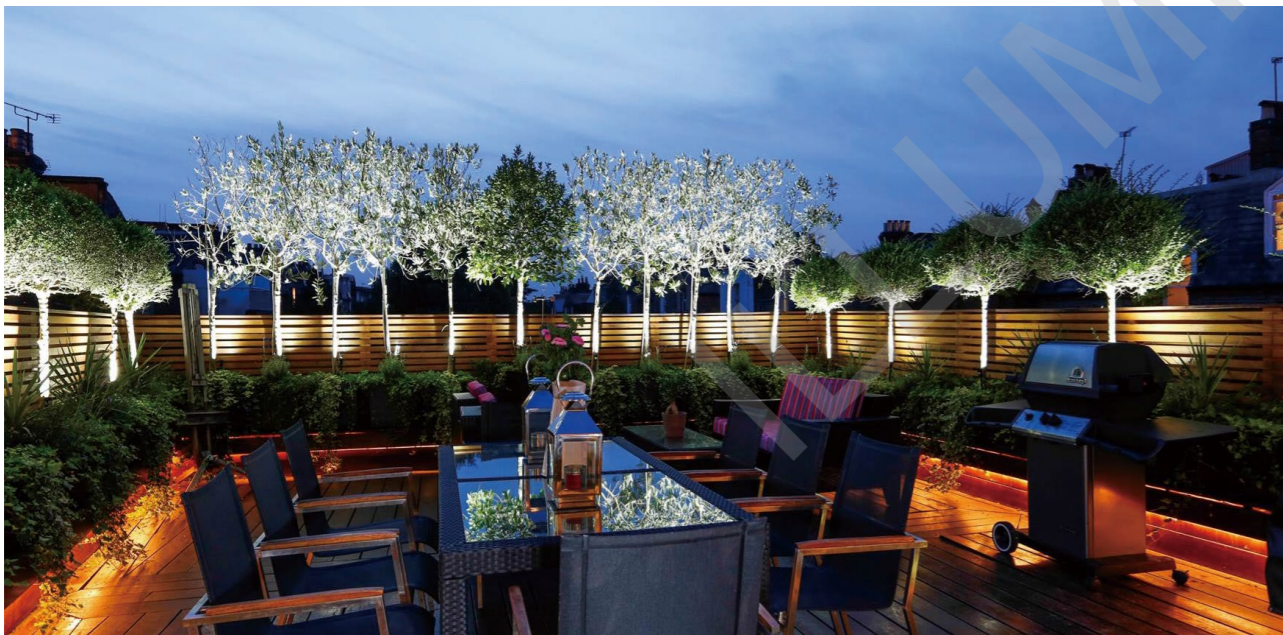
Parameter	
General Data	
Item No.	UL-1012-MR16-A-54
Power	/
LED type	Without MR16 lamp as standard, with MR16 lamp as options.
Luminous flux	for fitting MR16 lamp with totally height 54mm at max (including pins)
CCT	/
CRI	/
Beam angle	/
Dimension	61 x 95 (mm) Diameter x Height
Cut out	/
Net weight	0.53 kgs
Warranty	1 year
Certifications	CE, RoHS
Electrical Data	
Input voltage	DC12V
Insulation class	Class III
Cable	1PC rubber cable 1M H05RN-F 2x1mm square
Driver	/
Construction Data	
IP rating	IP67 Waterproof
IK rating	IK04
Housing	Solid Passivated (Anodizing) Aluminum CNC machined
Protection finishing	anodizing + powder coated painting in dark grey as standard, black or white as options
Trim	Passivated (Anodizing) Aluminum
Glass	Step tempered Glass, T=3mm.
Loading capacity	220 kgs
Cable Gland	PG7 IP67
Gasket	O-ring PMQ silicone seal
Accessories	
Spike	With PVC spike as spike spot lights (Standard)
Round base	With SS304 round base for wall mounting (optional)
Packaging	
Inner box size	130*115*80 mm
Carton size	36.5*28*26cm (18PCS each carton)

Dimension



CE RoHS COMPLIANT IP67 IK04
Passivated 1 Year Warranty

Application Picture





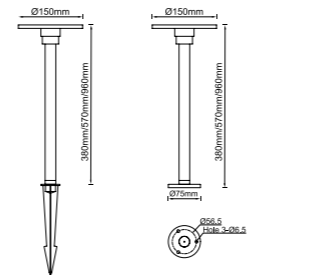
CE RoHS COMPLIANT IP65 IK04
1 Year Warranty

GARDEN SPOT LIGHTS SERIES

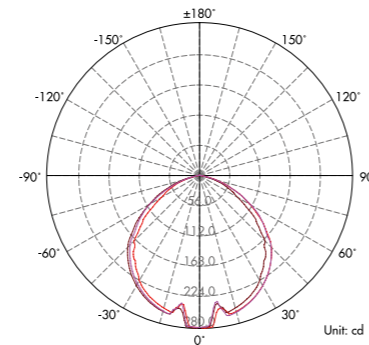
Parameter

General Data	
Item No.	LL-4801-0900-A
Power	9 Watts +10%
LED type	48PCS OSRAM 2835 SMD LED
Luminous flux	700lm +10%
CCT	2700K, 3000K, 4000K, 6000K
CRI	80+
Beam angle	100°
Dimension	Ø150*960mm / Ø150*570mm / Ø150*380mm optional
Cut out	/ mm
Net weight	/ kgs
Warranty	1 year
Certifications	CE, RoHS
Electrical Data	
Input voltage	DC24V
Insulation class	Class III
Cable	1PC rubber cable 1M HO5RN-F 2 x 1mm square
Driver	Constant low voltage input constant current output for LEDs
Construction Data	
IP rating	IP65 Waterproof
IK rating	IK04
Housing	Solid Passivated (Anodizing) Aluminum CNC machined
Protection finishing	20~25µm thickness anodized film for housing .Dark grey
Trim	Passivated (Anodizing) Aluminum
Glass	Tempered glass T=3mm
Loading capacity	/
Cable Gland	PG gland
Gasket	O-ring PMQ silicone seal
Accessories	
Spike	with Aluminium spike for ground installation
Round base	With SS304base for concrete ground installation
Packaging	
Inner box size	/ mm
Carton size	/ cm (/ PCS / carton)

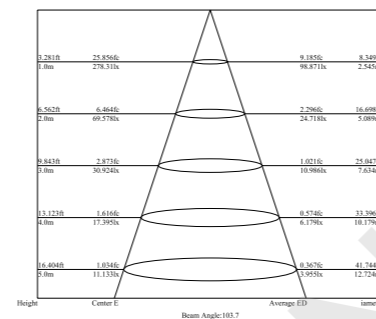
Dimension



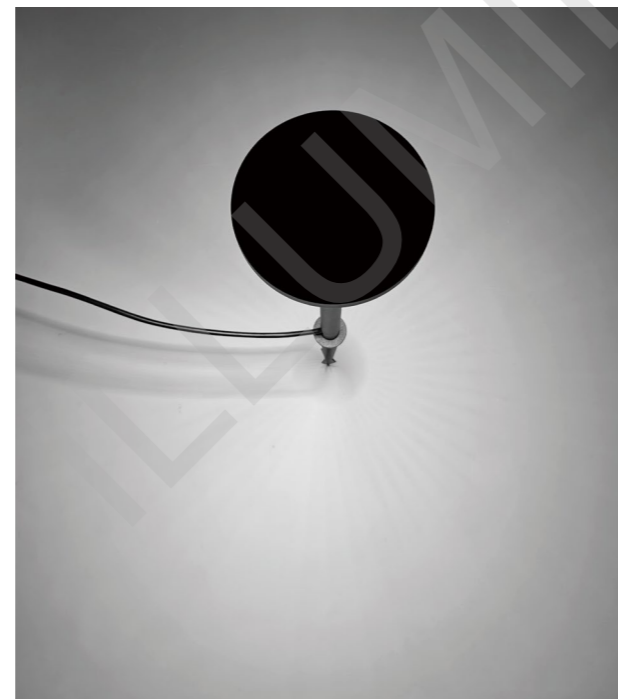
Light Distribution Curve (3000K, 100°)



Lux distance Curve (3000K, 100°)



Illumination Picture (100°)





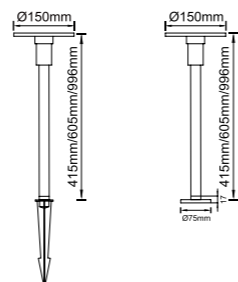
CE RoHS COMPLIANT IP65 IK04

1 Year Warranty

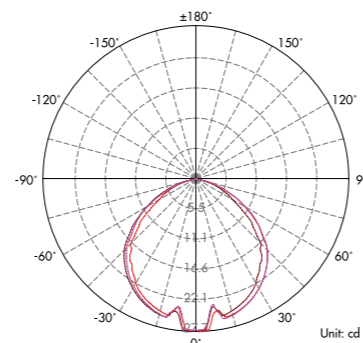
Three different heights as options !

Parameter	
General Data	
Item No.	LL-4801-0700-AH
Power	7 Watts ± 10%
LED type	48PCS OSRAM 2835 SMD LED
Luminous flux	470lm ± 10%
CCT	2700K, 3000K, 4000K, 6000K
CRI	80+
Beam angle	100°
Dimension	Ø150*415mm or 605mm or 996mm Diameter x Height] optional
Cut out	/ mm
Net weight	/ kgs
Warranty	1 year
Certifications	CE, RoHS
Electrical Data	
Input voltage	AC100-265V
Insulation class	Class I
Cable	1PC rubber cable 1.5M H05RN-F 3 x 1mm square
Driver	builtin constant current driver
Construction Data	
IP rating	IP65 Waterproof
IK rating	IK04
Housing	Solid Passivated (Anodizing) Aluminum CNC machined
Protection finishing	anodizing + powder coated painting in dark grey
Trim	Aluminum
Glass	Tempered glass T=3mm
Loading capacity	/
Cable Gland	PG gland
Gasket	O-ring PMQ silicone seal
Accessories	
Spike	with 205mm height Aluminium spike for ground installation with SS304 Pedal that can be used with spike for pushing the spike light into the ground by foot
Pedal	With SS304 base in dark grey as optional for concrete ground installation
Packaging	
Inner box size	/ mm
Carton size	/ cm (/ PCS / carton)

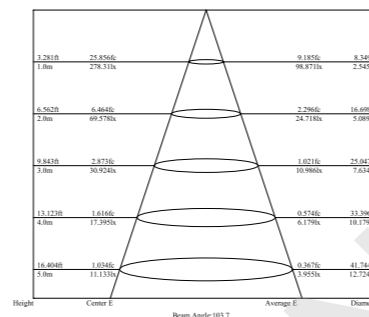
Dimension



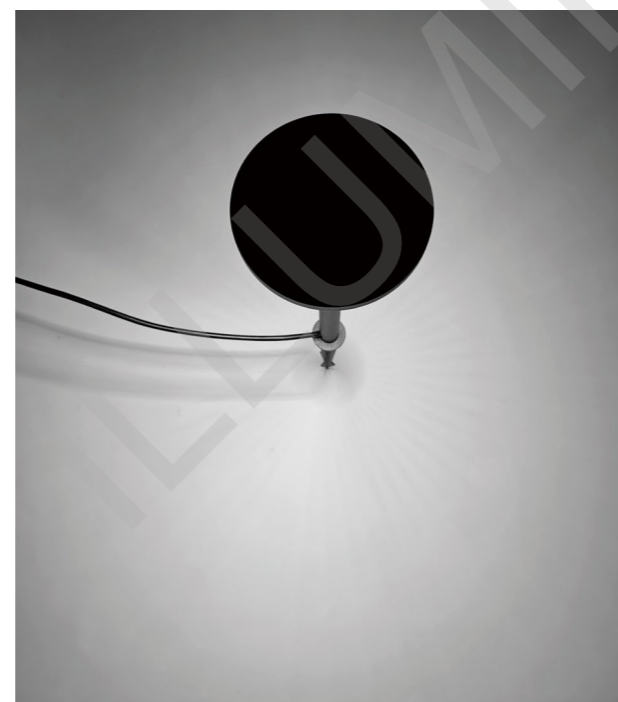
Light Distribution Curve (3000K, 100°)



Lux distance Curve (3000K, 100°)



Illumination Picture (100°)



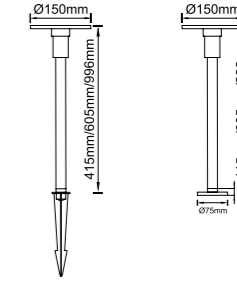
CE RoHS COMPLIANT IP65 IK04

1 Year Warranty

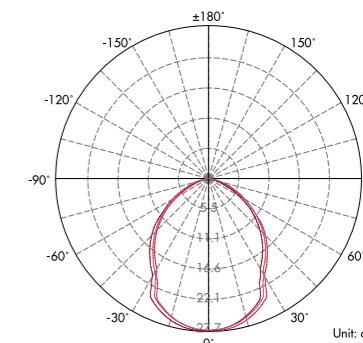
Three different heights as options !
With solar panel and lithium battery !

Parameter	
General Data	
Item No.	LL-4801-0200-A (SOLAR)
Power	2 Watts ± 10%
LED type	48PCS OSRAM 2835 SMD LED
Luminous flux	70lm ± 10%
CCT	2700K, 3000K, 4000K, 6000K
CRI	80+
Beam angle	100°
Dimension	Ø150*415mm or 605mm or 996mm Diameter x Height] optional
Cut out	/ mm
Net weight	/ kgs
Warranty	1 year
Certifications	CE, RoHS
Electrical Data	
Charging Mode	Solar Energy directly, no power cable.
Battery	With lithium battery 3.7V 3700mAh Battery charging and discharging Times 1200 @ max
Charging Time	≥10 H in the sunlight
Working Hours	8 hours working time (rst 4 hours 100% lumen, left 4 hours 50% lumen)
Construction Data	
IP rating	IP65 Waterproof
IK rating	IK04
Housing	Solid Passivated (Anodizing) Aluminum CNC machined
Protection finishing	anodizing + powder coated painting in dark grey
Trim	Aluminum
Glass	Tempered glass T=3mm
Loading capacity	/
Cable Gland	/
Gasket	O-ring silicone seal
Accessories	
Spike	with 205mm height Aluminium spike for ground installation with SS304 Pedal that can be used with spike for pushing the spike light into the ground by foot
Pedal	With SS304 base in dark grey as optional for concrete ground installation
Packaging	
Inner box size	/ mm
Carton size	/ cm (/ PCS / carton)

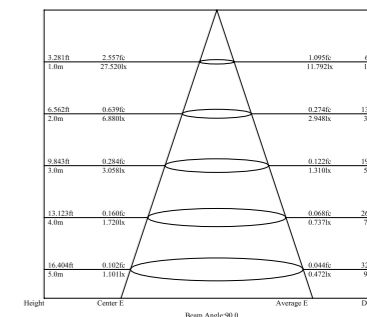
Dimension



Light Distribution Curve (3000K, 100°)



Lux distance Curve (3000K, 100°)



Illumination Picture (100°)





Pole for garden spot lights series



Specifications	Dimension
Item Pole-300 with base Pole Ø25mm x 300mm (Diameter x height) , Aluminium anodizing + powder coated painting in dark grey as standard, black as optional Base Ø75mm SS304 round base as optional for concrete ground installation, painted in dark grey as standard, black color as options	

Specifications	Dimension
Item Pole-300 with spike and pedal Pole Ø25mm x 300mm (Diameter x height) , Aluminium anodizing + powder coated painting in dark grey as standard, black as optional Spike With Aluminium spike powder coated painting in dark grey as standard,black color as options 205 mm height Pedal SS304 Pedal that can be used with spike for pushing the spike light into the ground by foot	

Specifications	Dimension
Item Pole-500 with base Pole Ø25mm x 500mm (Diameter x height) , Aluminium anodizing + powder coated painting in dark grey as standard, black as optional Base Ø75mm SS304 round base as optional for concrete ground installation, painted in dark grey as standard, black color as options	

Specifications	Dimension
Item Pole-500 with spike and pedal Pole Ø25mm x 500mm (Diameter x height) , Aluminium anodizing + powder coated painting in dark grey as standard, black as optional Spike With Aluminium spike powder coated painting in dark grey as standard,black color as options 205 mm height Pedal SS304 Pedal that can be used with spike for pushing the spike light into the ground by foot	

Specifications	Dimension
Item Pole-750 with base Pole Ø25mm x 750mm (Diameter x height) , Aluminium anodizing + powder coated painting in dark grey as standard, black as optional Base Ø75mm SS304 round base as optional for concrete ground installation, painted in dark grey as standard, black color as options	

Specifications	Dimension
Item Pole-750 with spike and pedal Pole Ø25mm x 750mm (Diameter x height) , Aluminium anodizing + powder coated painting in dark grey as standard, black as optional Spike With Aluminium spike powder coated painting in dark grey as standard,black color as options 205 mm height Pedal SS304 Pedal that can be used with spike for pushing the spike light into the ground by foot	



The Pole can be used with PLAYLITE'S 3W,5W,8W,12W,15W garden spot lights series

Parameter		
General Data			
Item	UL-1010-0800-AH with Pole	UL-15W-COB-1500-BH with Pole	UL-12W-COB-1200-BH with Pole
Power	8W	15W	12W
Input voltage	AC100-265V	AC100-265V	AC100-265V
CCT	2700K, 3000K, 4000K, 6000K	2700K, 3000K, 4000K, 6000K	2700K, 3000K, 4000K, 6000K
Beam angle	Reactor 10°, 23°, 38° (lens 15°, 24°, 36°, 60° optional+ or with honey comb optional) (lens 4° optional)	Reactor 25°, 38°, 60° (lens 10°23°36° + honey comb optional)	Zoom 10° to 60° adjustable
IP	IP67	IP67	IP67



15W polespot as signlight on the wall

8W polespot for path

8W polespot for lawn








Optional Accessories for Garden Spot Lights Series Spike

	Specifications	Suitable for items:
Spike-175 	Plastic PP spike for ground spike installation. Ø39X175 mm (DiameterxLength),black color,with screws M4*10mm	Garden spot lights with power from 3 watts to 15 watts.
Spike-230 	Plastic PP spike as options for the above spot lights. so that it can be for ground spike installation. 50x230 mm(DiameterxLength),black color For garden spot light series	Garden spot lights with power from 3 watts to 25 watts.
Spike-160 	Aluminium spike for ground spike installation. Ø40X160 mm (DiameterxLength), black color as standard,dark grey color or silver color optional,with screws M4*10mm	Garden spot lights with power from 3 watts to 15 watts.
Spike-205 	Aluminium spike as options for the above spot lights. so that it can be for ground spike installation. Ø40X205 mm (DiameterxLength), black color as standard,dark grey color or silver color optional,with screws M6*10mm	Garden spot lights with power from 3 watts to 25 watts.
Spike-260 	Aluminium spike as options for the above spot lights. so that it can be for ground spike installation. Ø60X260 mm (DiameterxLength), black color as standard,dark grey color or silver color optional,with screws M6*10mm For garden spot light series	Garden spot lights with power ≥25 watts and below items:FL-1701-1700-AH,FL-1701-3400-AH,FL-3601-3600-AH,FL-3601-5000-AHFL,FL-3600-RGB.
Pedal for spike 	Stainless steel 304 materials. Pedal that can be used with spike for pushing the spike light into the ground by foot. For garden spot light series	All of garden spot lights series.



Round base

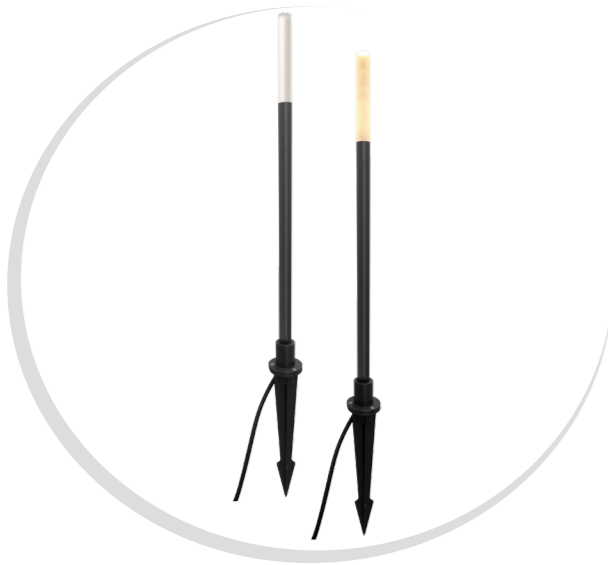
	Specifications	Suitable for items:
Round Base-75 	75mm Stainless steel 304 base as options for the above spot lights. so that it can be for wall surface mounted installation. For garden spot light series	All of garden spot lights series
Black or dark grey Round Base-75 	Powder coated painted in black or dark grey 75mm Stainless steel 304 base as options for the above spot lights. so that it can be for wall surface mounted installation. For garden spot light series	All of garden spot lights series
Black or dark grey Round Base-110 	Powder coated painted in black or dark grey 110mm Stainless steel 304 base as options for the above spot lights. so that it can be for wall surface mounted installation. For garden spot light 18W, 25W	All of garden spot lights series

Shield(Snoot / Hood)

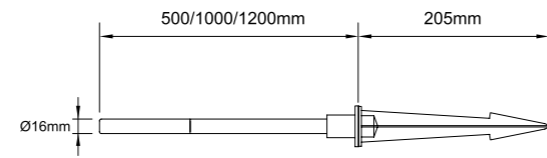
	Specifications	Suitable for items:
Shield for UL-1004 	Anti-glare Shield (Snoot / Hood) for garden spot lights. 35mm diameter Passivated+powder coated painting dark grey color as standard, black,silver color or white color as options	UL-1004-0300-A
Shield-48 	Anti-glare Shield (Snoot / Hood) for garden spot lights. 48mm diameter. Passivated +powder coated painting dark grey color as standard, black,silver color or white color as options	UL-1010-0500-BH UL-1010-0500-CH UL-1010-0900(RGB)-A
Shield-49 	Anti-glare Shield (Snoot / Hood) for garden spot lights. 49mm diameter. Passivated+powder coated painting dark grey color as standard, black,silver color or white color as options	UL-1010-0800-AH UL-1010-0800-BH UL-1010-0800-BH
Shield-66 	Anti-glare Shield (Snoot/ Hood) for garden spot lights. 66mm diameter. Passivated +powder coated painting dark grey color as standard, black,silver color or white color as options	UL-1010-1200(RGBW)-A UL-1012-1200-AH UL-15W-COB-1500-BH UL-1019-1200-AH UL-1012-MR16-A-54 UL-1012-GU10-A-70 UL-1012-GU10-A
Shield-80 	Anti-glare Shield (Snoot/ Hood) for garden spot light. 80mm diameter. Passivated +powder coated painting dark grey color as standard, black,silver color or white color as options	UL-1012-1800-AH
Shield-95 	Anti-glare Shield (Snoot/ Hood) for garden spot light. 95mm diameter. Passivated +powder coated painting dark grey color as standard, black,silver color or white color as options	UL-25W-COB-2500-BH

Belt

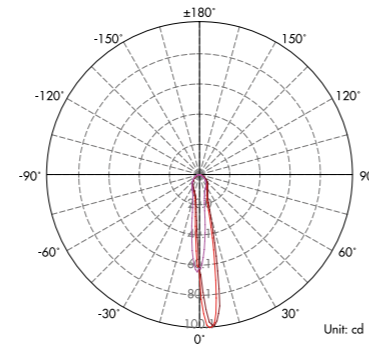
	Specifications	Suitable for items:
Belt-2M-001 	Belt (25mm width) for Garden spot lights tree installation Included 1 PC Stainless steel 304 fixed part for 1 PC fixture surface mounted. (More fixed parts are as optional) 2M Nylon materials belt in black	UL-1004-0300-A UL-4002-0400-A UL-1010-0500-BH UL-1010-0500-CH UL-1010-0800-AH UL-1010-0800-BH UL-1010-0900 (RGB)-A UL-1010-1200 (RGBW)-A
Belt-2M-002 	Belt (38mm width)for Garden spot lights tree installation Included 3PCS Stainless steel 304 fixed part for 1-3 PCS fixture surface mounted as standard. 2M Nylon materials belt in black	UL-1012-1200-AH UL-15W-COB-1500-BH UL-1019-1200-AH UL-12W-COB-BH UL-15W-COB-1500-FH UL-1012-GU10-A-70 UL-1012-GU10-A-54



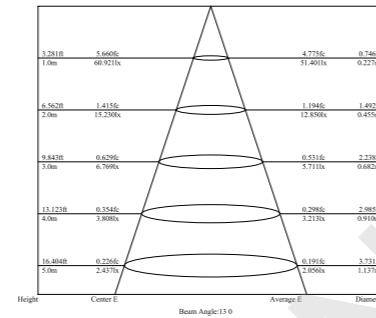
Dimension



Light Distribution Curve (3000K, 110°)



Lux distance Curve (3000K, 110°)



Illumination Picture (110°)



CE RoHS COMPLIANT IP65

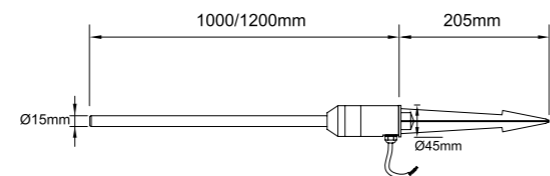
1 Year Warranty

Parameter

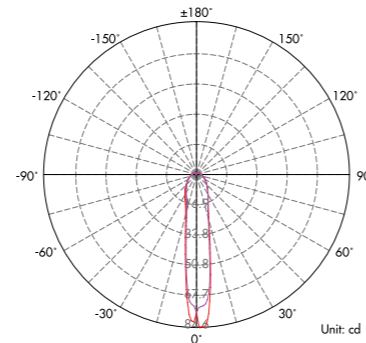
General Data	
Item No.	LL-1001-0100-B
Power	1.4W±10%
LED type	1 PC 3W OSRAM 3030 LED
Luminous flux	35lm ± 10%
CCT	2700K, 3000K, 4000K, 6000K
CRI	80+
Beam angle	110°
Dimension	500 or 1000 or 1200*16 (mm) (Length x Diameter)
Cut out	/
Net weight	0.43 /0.4 kgs
Warranty	1 year
Certifications	CE, RoHS
Electrical Data	
Input voltage	DC 12V-DC24V
Insulation class	Class III
Cable	1PC rubber cable 1M HO5RN-F 2x0.5mm square
Driver	Low constant voltage input driver, constant current output for LEDs
Construction Data	
IP rating	IP65 Waterproof
IK rating	IK02
Housing	Aluminum tube
Protection finishing	Anodized + powder coated painted in dark grey
Top	frosted PMMA top part
Loading capacity	/
Cable Gland	Aluminum gland
Gasket	silicone glue seal
Accessories	
Spike	With Aluminium spike painting in dark grey, 205 mm height
Packaging	
Inner box size	/ mm
Carton size	/ cm (/ PCS / carton)



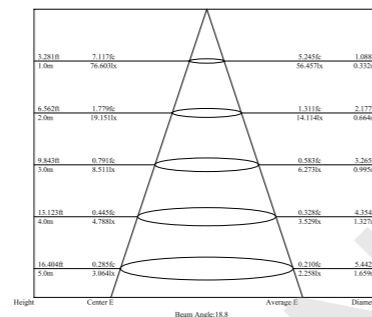
Dimension



Light Distribution Curve (3000K, 110°)



Lux distance Curve (3000K, 110°)



Illumination Picture (110°)



CE RoHS COMPLIANT IP65

1 Year Warranty

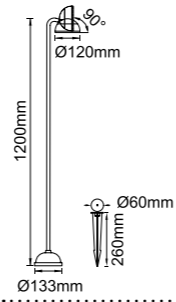
Parameter

General Data	
Item No.	AC100-265V: IL-1001-0300CH / DC12V-24V: IL-1001-0300-C
Power	3.5W ± 10%
LED type	1 PC 3V CREE MHB LED
Luminous flux	60lm ± 10%
CCT	2700K, 3000K, 4000K, 6000K
CRI	80+
Beam angle	110°
Dimension	1200 or 1000*15/45 (mm) (Length x Diameter top/Diameter base)
Cut out	/
Net weight	0.65 kgs /0.6 kgs
Warranty	1 year
Certifications	CE, RoHS
Electrical Data	
Input voltage	AC100~265V or DC12V-24V
Insulation class	Class I or III
Cable	1PC rubber cable 1M HO5RN-F 3 or 2 x 1mm square
Driver	AC100-265V: with built-in constant current driver for LEDs DC24V: constant low voltage input, constant current output for LEDs
Construction Data	
IP rating	IP65 Waterproof
IK rating	IK02
Housing of base	Aluminum
Protection finishing	Anodized + powder coated painted in dark grey
Top	frosted PMMA top part
Body	double tubes: one PMMA tube with bubbles inside + one PC tube outside
Loading capacity	/
Cable Gland	PG gland
Gasket	silicone glue seal
Accessories	
Spike	With Aluminium spike painting in dark grey, 205 mm height
Packaging	
Inner box size	/ mm
Carton size	/ cm (/ PCS / carton)

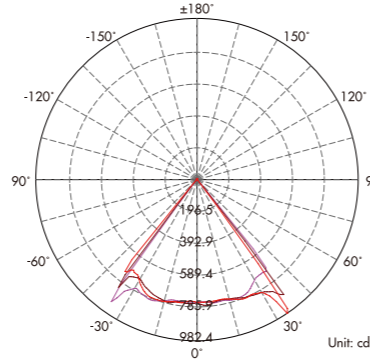
Landsun



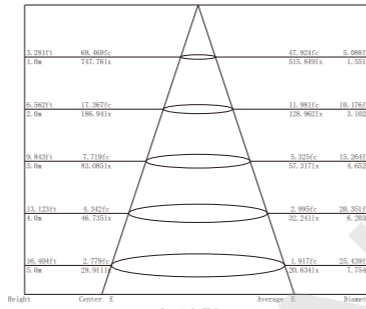
Dimension



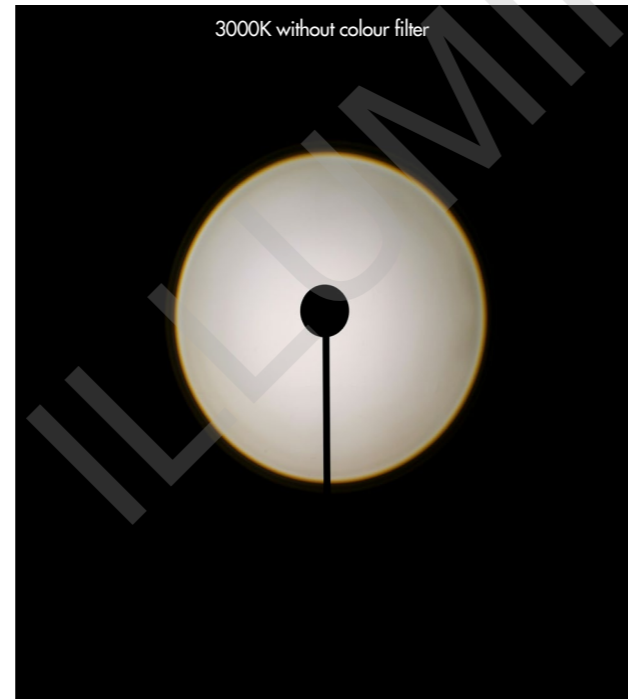
Light Distribution Curve (3000K, 70°)



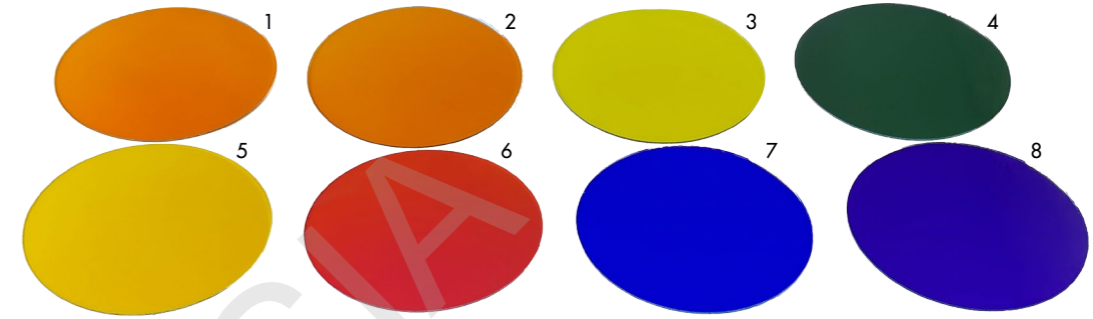
Lux distance Curve (3000K, 70°)



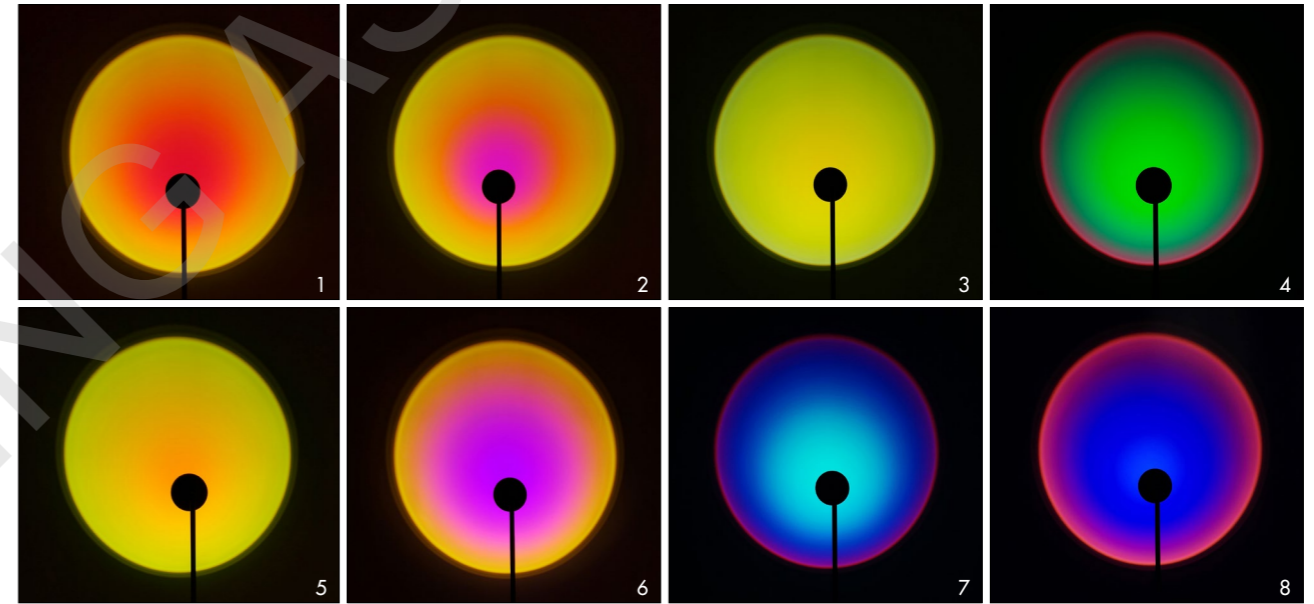
Illumination Picture (70°)



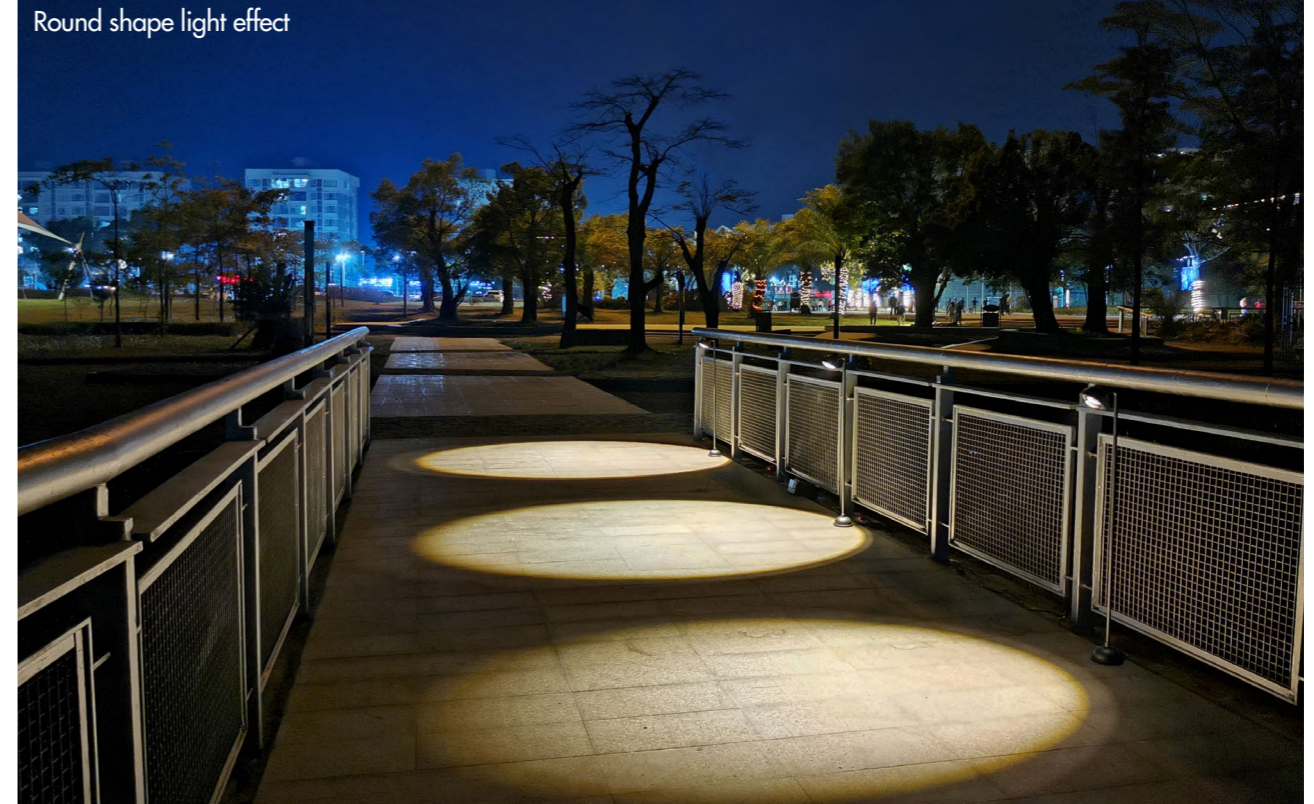
8 kinds of colour filters as options for Landsun !



3000K with colour filters light effect



Round shape light effect



CE RoHS COMPLIANT IP65 IK04

1 Year Warranty

8 kinds of colour filters as options !

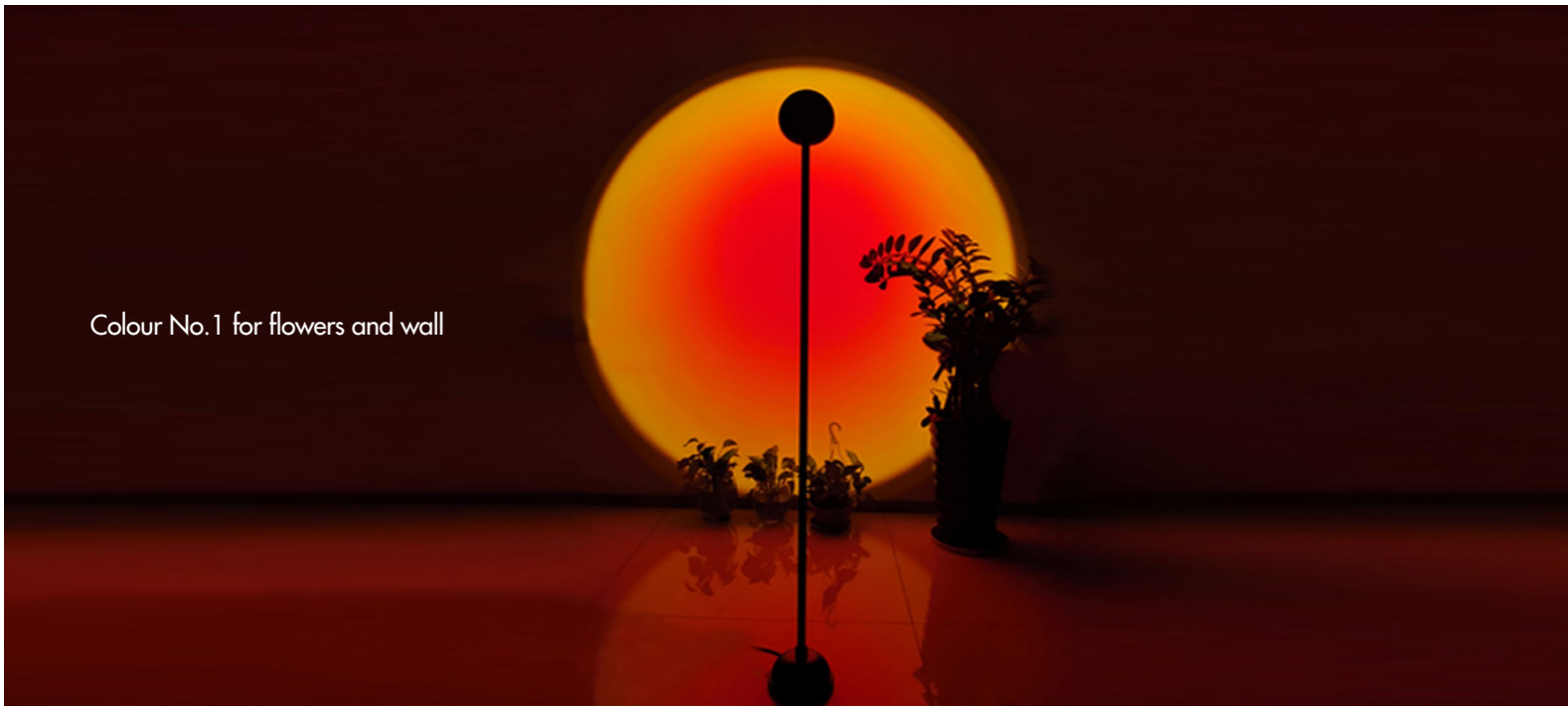
Parameter

General Data	
Item No.	LL-15W-COB-1500-AH
Power	1.5 Watts ±10%
LED type	1 PC 15W CREE CXA1512 COB LED
Luminous flux	1000lm ± 10% @ 3000K, 70°
CCT	2700K, 3000K, 4000K, 6000K
CRI	80+
Beam angle	70°
Dimension	Ø120*Ø133*1200 (mm) (Top Diameter x Bottom Diameter x height)
Cut out	/ mm
Net weight	2.5 kgs
Warranty	1 year
Certifications	CE, RoHS
Electrical Data	
Input voltage	AC100-265V
Insulation class	Class I
Cable	1PC rubber cable 1M H05RN-F 3 x 1mm square
Driver	built-in constant current driver
Construction Data	
IP rating	IP65 Waterproof
IK rating	IK04
Housing	Solid Passivated (Anodizing) Aluminum CNC machined
Protection finishing	anodizing + powder coated painting in dark grey
Trim	Aluminum
Glass	convex glass. T=22 mm.
Loading capacity	/
Cable Gland	PG gland
Gasket	silicone ring + silicone glue seal
Accessories	
Spike	with 2PCS dark grey Aluminium spike for earth installation
Round base	round base mounted part with screws for ground mounted
Packaging	
Inner box size	1300*300*150 mm
Carton size	132*62*32 cm (4 PCS / carton)

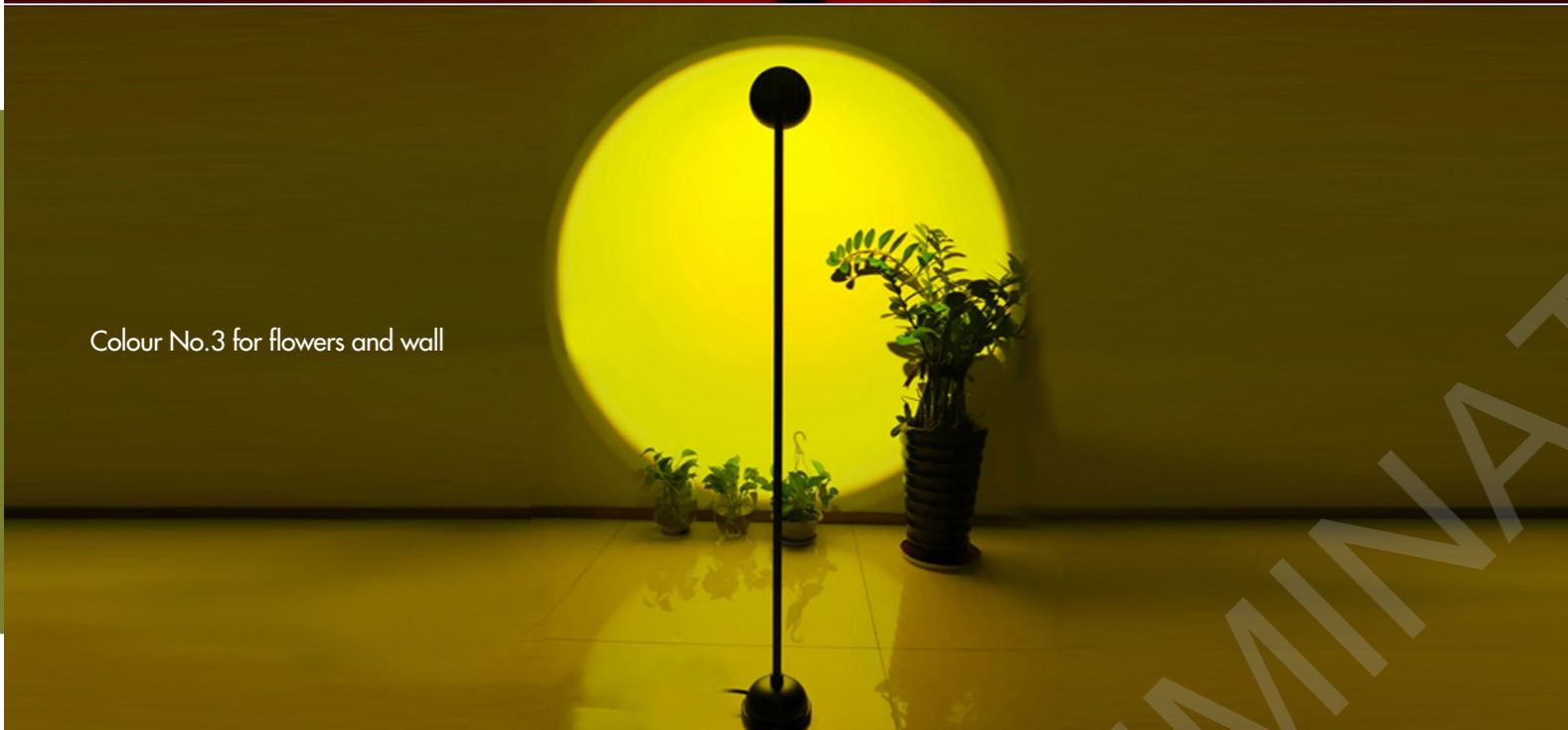


Colour No.1 for flowers

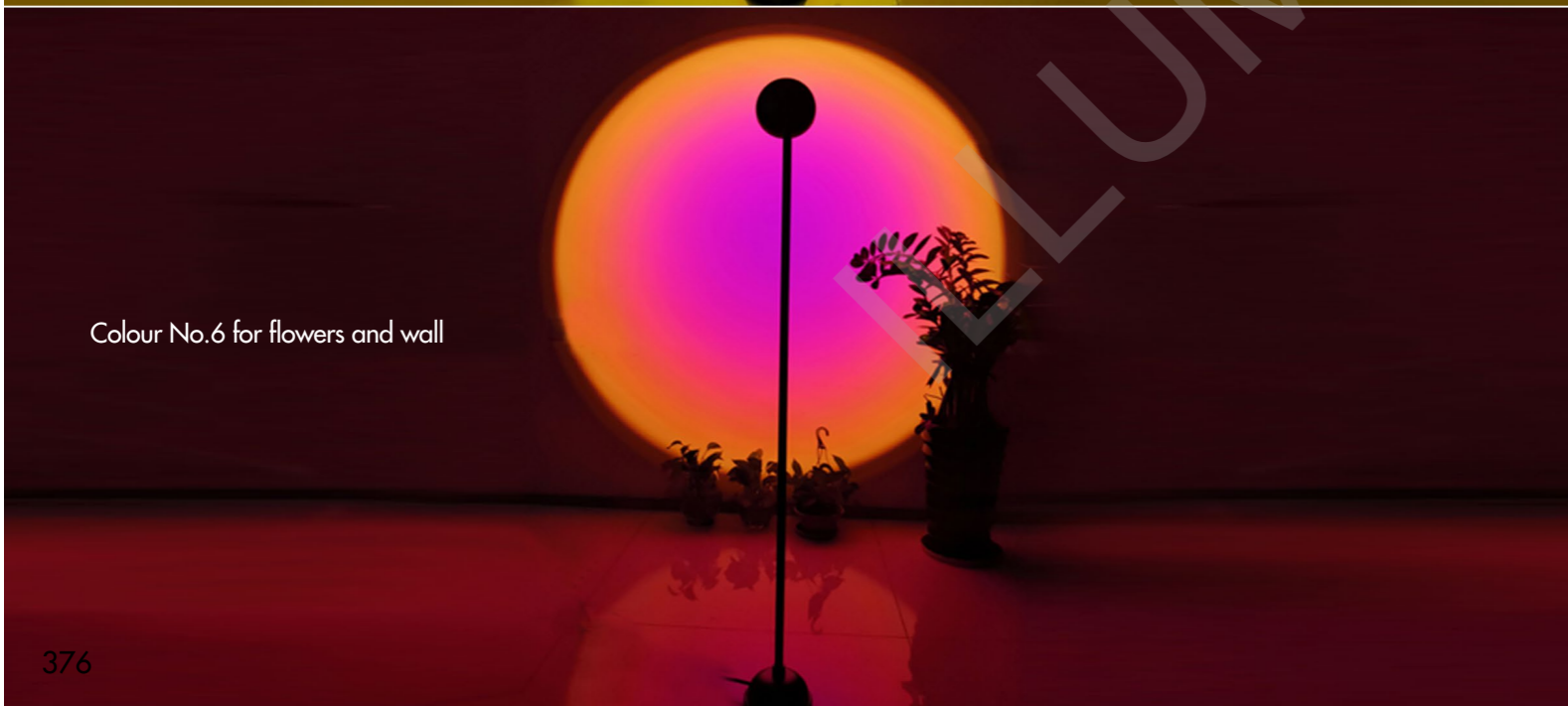




Colour No.1 for flowers and wall



Colour No.3 for flowers and wall



Colour No.6 for flowers and wall



Oval shape light effect by adjusting direction



3000K for pandas and grass



Colour No.3 for pandas and grass



Playball 150



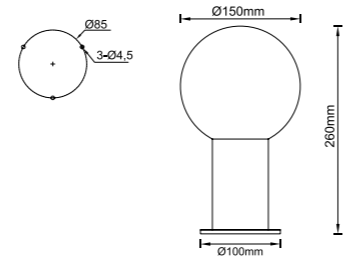
CE RoHS COMPLIANT IP65 IK07

Passivated 1 Year Warranty

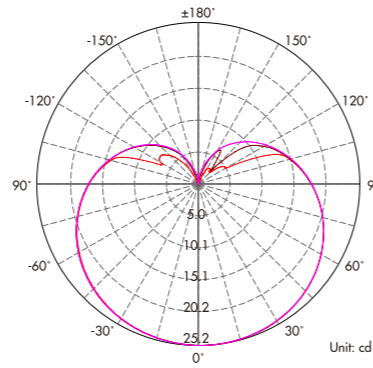
Parameter

General Data	
Item No.	LL-Ø150-0200-A
Power	2 Watts +10%
LED type	18 PCS OSRAM 2835 LED
Luminous flux	200lm +10%
CCT	2700K, 3000K, 4000K, 6000K
CRI	80+
Beam angle	300°
Dimension	Ø150*438 (mm) Diameter x length
Cut out	/ mm
Net weight	0.6 kgs
Warranty	1 year
Certifications	CE, RoHS
Electrical Data	
Input voltage	DC24V
Insulation class	Class III
Cable	1PC rubber cable 1m H05RN-F 2 x 1mm square
Driver	low constant voltage input, constant current output for LEDs
Construction Data	
IP rating	IP65 Waterproof
IK rating	IK07
Housing	Solid Passivated (Anodizing) Aluminum CNC machined
Protection finishing	Anodized +Powder coated painting in dark grey
Trim	PE shield
Glass	/
Loading capacity	/
Cable Gland	PG gland
Gasket	silicone ring + silicone glue seal
Accessories	
Spike	With spike for earth mounting
Round base	With round base for surface mounting
Packaging	
Inner box size	200*200*300 mm
Carton size	42*42*32 cm (2PCS / carton)

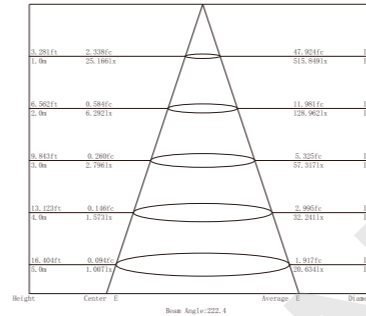
Dimension



Light Distribution Curve (3000K, 300°)



Lux distance Curve (3000K, 300°)



Illumination Picture (300°)





Specialized in Exterior LED Lighting

WALL LIGHTS SERIES

Products Features

These products are designed with special design milky white glass trim or the plated aluminium trim, Aluminum housing, with passivated (anodizing) anti-corrosion finishing for housing or anodized / plated aluminium housing, optics PMMA lens with wonderful light output, silicone gasket and cable gland for waterproof IP65 or IP67 and high quality CREE LED, EPISTAR LED.

We make several series of wall lights to meet different application, and even the wall lights with lithium battery that's used as emergency lights, the wall lights with touched controlled trim for dimming, turning off or on series are available.

These products are with CE, RoHS certifications, and the SAA, PSE, UL or ETL certifications will be available in the coming future.

Application

These lights are widely used in the exterior or interior application, such as lighting stairs, corner of walls for the house, hotel, the garden, the park etc.

Passivated

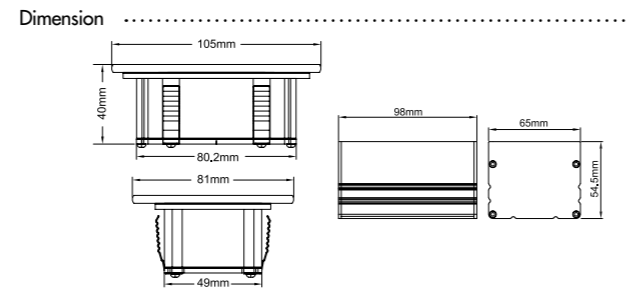
1 Year Warranty



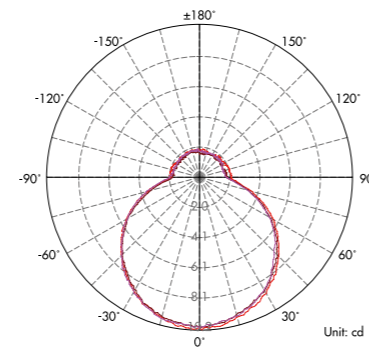
IP65 IP67 IK06



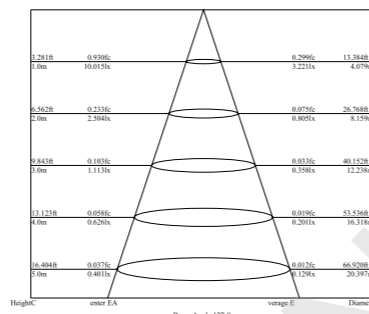
ILLUMINATING ASIA



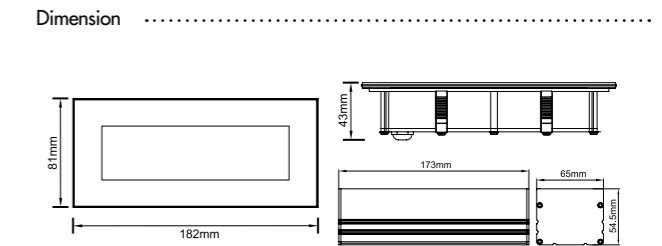
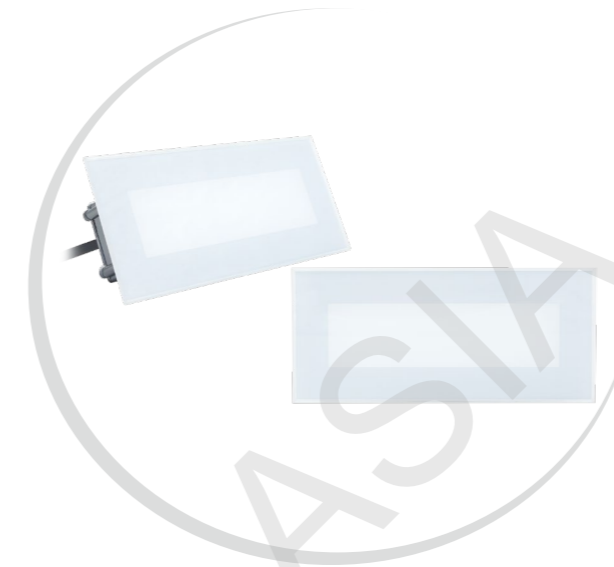
Light Distribution Curve (3000K, 120°)



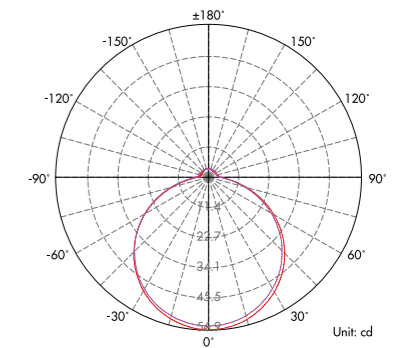
Lux distance Curve (3000K, 120°)



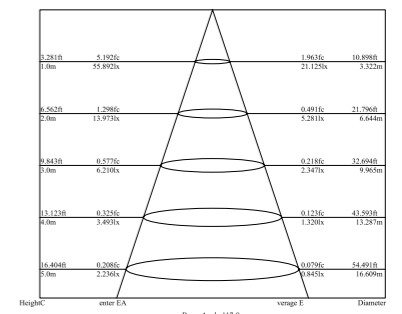
Illumination Picture (120°)



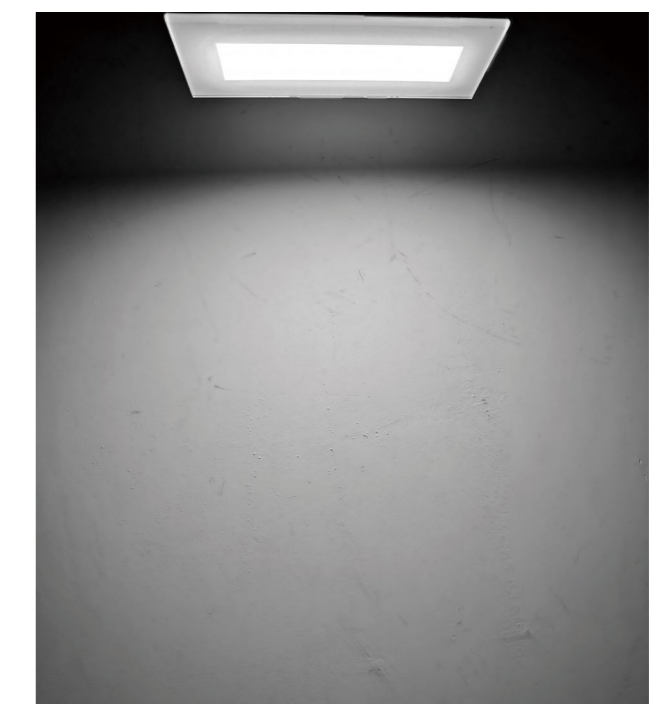
Light Distribution Curve (3000K, 120°)



Lux distance Curve (3000K, 120°)



Illumination Picture (120°)



CE RoHS COMPLIANT IP65 IK06

Passivated 1 Year Warranty

Parameter	
General Data	
Item No.	SP001-0400-AH
Power	4 Watts
LED type	30 pcs 2835 SMD LED
Luminous flux	100~120 lm
CCT	2700K, 3000K, 4000K, 6000K
CRI	80+
Beam angle	120°
Dimension	105x81x40 mm (Length x Wide x Height)
Cut out	98x65x54.5mm
Net weight	0.369 kgs
Warranty	1 year
Certifications	CE, RoHS
Electrical Data	
Input voltage	AC100~240V
Insulation class	Class I
Cable	1 x cable 0.3 M H05RN-F 3x0.75mm square to open wires
Driver	Built-in high voltage constant current driver with transformer
Construction Data	
IP rating	IP65 Waterproof
IK rating	IK06
Housing	Solid Passivated (Anodizing) Aluminum CNC machined
Protection finishing	20~25µm thickness anodized film for housing. Dark grey as standard, painted in white as options
Trim	Tempered glass painted in milky white
Glass	Tempered Glass, T=4mm.
Loading capacity	320 kgs
Cable Gland	PG7 IP67
Gasket	Flat PMQ silicone seal
Accessories	
Mounting box	Aluminum
Packaging	
Inner box size	130*105*80 mm
Carton size	54*28.5*34 cm (32 PCS/carton)

CE RoHS COMPLIANT IP65 IK06

Passivated 1 Year Warranty

Parameter	
General Data	
Item No.	SP005-0800-AH
Power	8 Watts
LED type	42 pcs 2835 SMD LED
Luminous flux	190~210 lm
CCT	2700K, 3000K, 4000K, 6000K
CRI	80+
Beam angle	120°
Dimension	182x81x43 mm (Length x Wide x Height)
Cut out	173 x 65 x 54.5 mm
Net weight	0.373 kgs
Warranty	1 year
Certifications	CE, RoHS
Electrical Data	
Input voltage	AC100~240V
Insulation class	Class I
Cable	1 x cable 0.3 M H05RN-F 3x0.75mm square to open wires
Driver	Built-in high voltage constant current driver with transformer
Construction Data	
IP rating	IP65 Waterproof
IK rating	IK06
Housing	Solid Passivated (Anodizing) Aluminum CNC machined
Protection finishing	20~25µm thickness anodized film for housing. Dark grey
Trim	Tempered glass painted in milky white
Glass	Tempered Glass, T=4mm.
Loading capacity	320 kgs
Cable Gland	PG7 IP67
Gasket	Flat PMQ silicone seal
Accessories	
Mounting box	Aluminum
Packaging	
Inner box size	208*105*70 mm
Carton size	42*22*46 cm (24 PCS / carton)



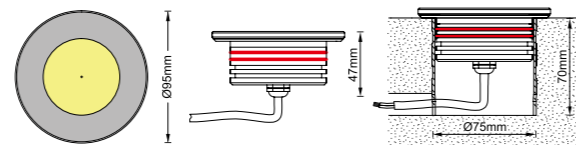
CE RoHS COMPLIANT IP65 IK06

Passivated 1 Year Warranty

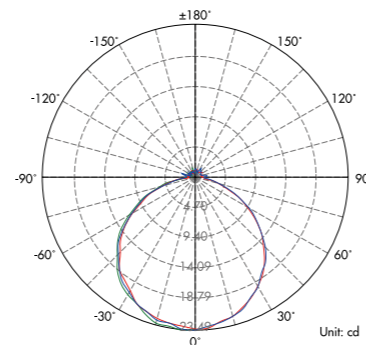
Asymmetrical downward reflector !

Parameter	
General Data	
Item No.	SP-003-0400-AH
Power	4 Watts
LED type	18 pcs 2835 SMD LED
Luminous flux	85-95 lm
CCT	2700K, 3000K, 4000K, 6000K
CRI	80+
Beam angle	120°
Dimension	95x47 (mm) Diameter x Height
Cut out	75 mm
Net weight	0.35 kgs
Warranty	1 year
Certifications	CE, RoHS
Electrical Data	
Input voltage	AC100~240V
Insulation class	Class I
Cable	1 x cable 0.3 M H05RN-F 3x0.75mm square to open wires
Driver	Built-in high voltage constant current driver with transformer
Construction Data	
IP rating	IP65 Waterproof
IK rating	IK06
Housing	Solid Passivated (Anodizing) Aluminum CNC machined
Protection finishing	20~25µm thickness anodized film for housing. Dark grey
Trim	Tempered glass painted in milky white
Glass	Tempered Glass. T=5mm.
Loading capacity	320 kgs
Cable Gland	PG7 IP67
Gasket	O-ring PMQ silicone seal
Accessories	
Mounting Sleeve	Anti-corrosion PVC. Grey.
Packaging	
Inner box size	125*125*95 mm
Carton size	64.3*39*21 cm (30 PCS / carton)

Dimension



Light Distribution Curve (3000K, 120°)



Lux distance Curve (3000K, 120°)

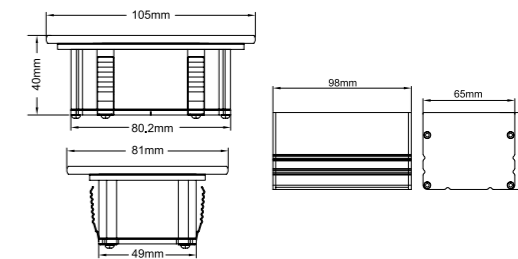
	Illuminance at a Distance	
	Center Beam LUX	Beam Width V H
2m	5.79 LUX	6.1m 6.2m
4m	1.45 LUX	12.1m 12.4m
6m	0.64 LUX	18.2m 18.7m
8m	0.36 LUX	24.3m 24.9m
10m	0.23 LUX	30.3m 31.1m
12m	0.16 LUX	36.4m 37.3m

Vert.Spread:113.3 Horiz.Spread:114.6

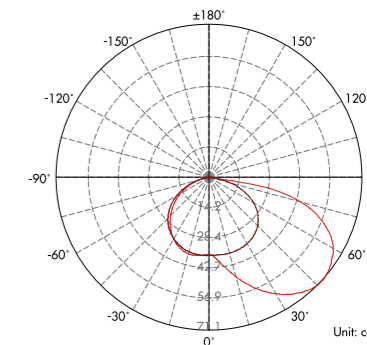
Illumination Picture (120°)



Dimension



Light Distribution Curve (4000K, 45° x 120°)

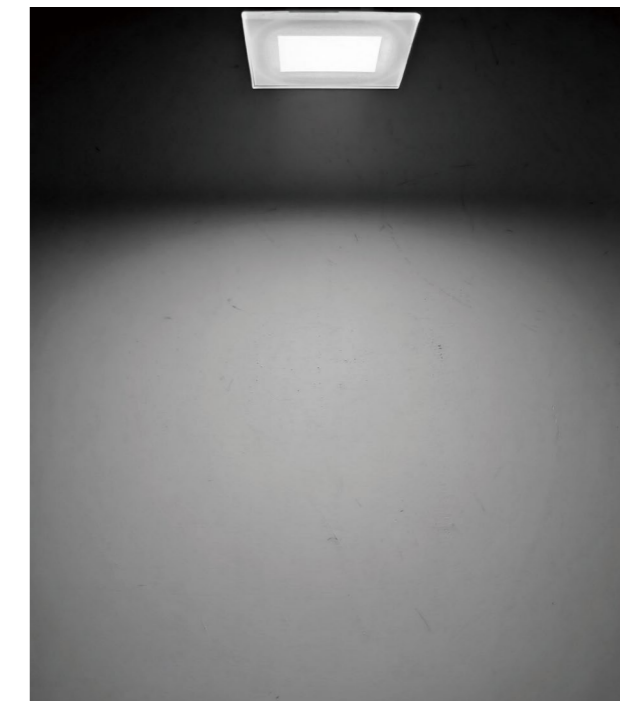


Lux distance Curve (4000K, 45° x 120°)

	Illuminance at a Distance	
	Center Beam LUX	Beam Width V H
2m	3.20 LUX	3.30m 3.33m
4m	0.80 LUX	6.60m 6.66m
6m	0.36 LUX	9.90m 10.00m
8m	0.20 LUX	13.20m 13.33m
10m	0.13 LUX	16.50m 16.67m
12m	0.09 LUX	19.80m 20.00m

Vert.Spread:113.3 Horiz.Spread:114.6

Illumination Picture (45°x120°)



CE RoHS COMPLIANT IP65 IK06

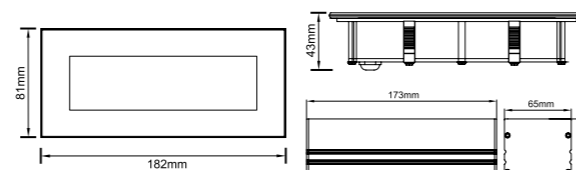
Passivated 1 Year Warranty

Asymmetrical downward reflector !

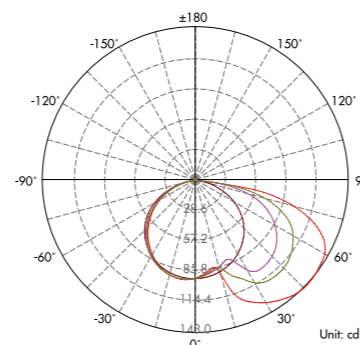
Parameter	
General Data	
Item No.	SP-001-0300-BH
Power	3 Watts
LED type	15 pcs 2835 SMD LED
Luminous flux	160~180 lm
CCT	2700K, 3000K, 4000K, 6000K
CRI	80+
Beam angle	Asymmetric downward 45° x 120° (Tilt x Pan)
Dimension	105x81x40 mm (Length x Wide x Height)
Cut out	98 x 65x 54.5 mm
Net weight	0.371 kgs
Warranty	1 year
Certifications	CE, RoHS
Electrical Data	
Input voltage	AC100~265V
Insulation class	Class I
Cable	1 x cable 0.3 M H05RN-F 3x0.75mm square to open wires
Driver	Built-in high voltage constant current driver with transformer
Construction Data	
IP rating	IP65 Waterproof
IK rating	IK06
Housing	Passivated (Anodizing) Aluminum CNC machined
Protection finishing	20~25µm thickness anodized film for housing. Dark grey
Trim	Tempered glass painted in milky white
Glass	Tempered Glass. T=4mm.
Loading capacity	320 kgs
Cable Gland	PG7 IP67
Gasket	Flat PMQ silicone seal
Accessories	
Mounting box	Aluminum
Packaging	
Inner box size	130*105*80 mm
Carton size	54*28.5*34 cm (32 PCS/carton)



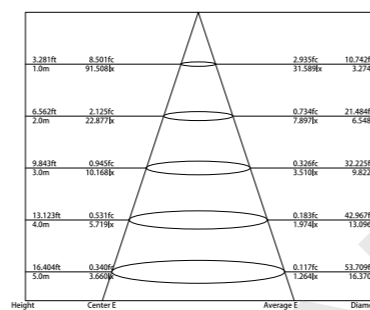
Dimension



Light Distribution Curve (3000K, 120°)



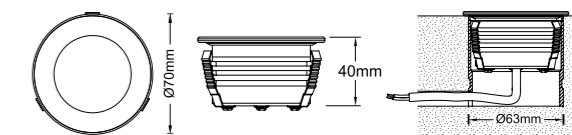
Lux distance Curve (3000K, 120°)



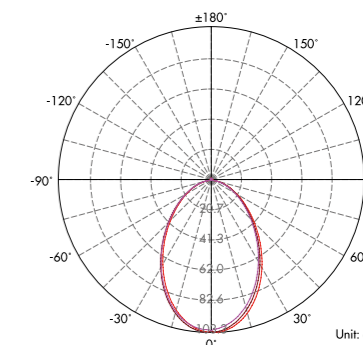
Illumination Picture (120°)



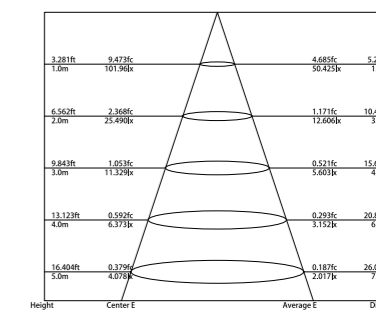
Dimension



Light Distribution Curve (3000K, 1x120°)



Lux distance Curve (3000K, 1x120°)



Illumination Picture (1x120°)



CE RoHS COMPLIANT IP65 IK06

Passivated 1 Year Warranty

Parameter

General Data	
Item No.	SP-005-0500-BH
Power	5 Watts
LED type	30 pcs 2835 SMD LED
Luminous flux	380~400 lm
CCT	2700K, 3000K, 4000K, 6000K
CRI	80+
Beam angle	Asymmetric downward 120°
Dimension	182x81x43 mm (Length x VWide x Height)
Cut out	173 x 65 x 54.5 mm
Net weight	0.450 kgs
Warranty	1 year
Certifications	CE, RoHS
Electrical Data	
Input voltage	AC100~265V
Insulation class	Class I
Cable	1 x cable 0.3 M H05RN-F 3x0.75mm square to open wires
Driver	Built-in high voltage constant current driver with transformer
Construction Data	
IP rating	IP65 Waterproof
IK rating	IK06
Housing	Passivated (Anodizing) Aluminum CNC machined
Protection finishing	20~25µm thickness anodized film for housing. Dark grey
Trim	Tempered glass painted in milky white
Glass	Tempered Glass. T=4mm.
Loading capacity	320 kgs
Cable Gland	PG7 IP67
Gasket	Flat PMQ silicone seal
Accessories	
Mounting box	Aluminum
Packaging	
Inner box size	208*105*70 mm
Carton size	42*22*46 cm (24 PCS / carton)

CE RoHS COMPLIANT IP65 IK06

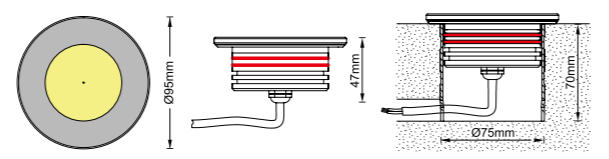
Passivated 1 Year Warranty

Parameter

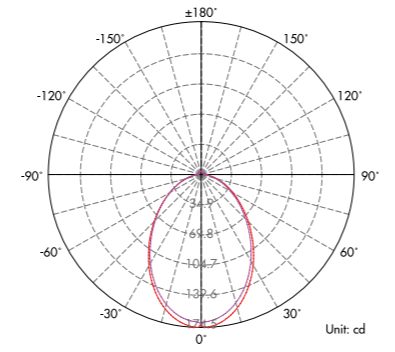
General Data	
Item No.	SP-004-0500-B
Power	5 Watts
LED type	15 pcs 3030 LED
Luminous flux	200~220 lm
CCT	2700K, 3000K, 4000K, 6000K, R/G/Y/B
CRI	80+
Beam angle	120°
Dimension	70 x 40 (mm) Diameter x Height
Cut out	63 mm
Net weight	0.26 kgs
Warranty	1 year
Certifications	CE, RoHS
Electrical Data	
Input voltage	DC24V
Insulation class	Class III
Cable	1PC rubber cable 0.3M H05RN-F 2x0.75mm square
Driver	Low voltage constant current output, excluding the transformer
Construction Data	
IP rating	IP65 Waterproof
IK rating	IK06
Housing	Solid Passivated (Anodizing) Aluminum CNC machined
Protection finishing	20~25µm thickness anodized film for housing. Dark grey
Trim	Frosted Tempered Glass.
Glass	Tempered Glass. T=5mm.
Loading capacity	320 kgs
Cable Gland	PG7 IP67
Gasket	O-ring PMQ silicone seal
Accessories	
Mounting Sleeve	Anti-corrosion PVC. Grey.
Clip	With strong clip as options for ceiling lights application
Packaging	
Inner box size	125*125*95 mm
Carton size	64.3*39*21 cm (30PCS / carton)



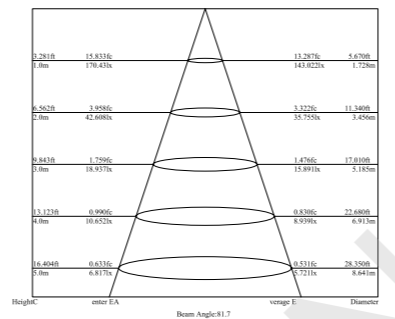
Dimension



Light Distribution Curve (3000K, 1x120°)



Lux distance Curve (3000K, 1x120°)



Illumination Picture (1x120°)



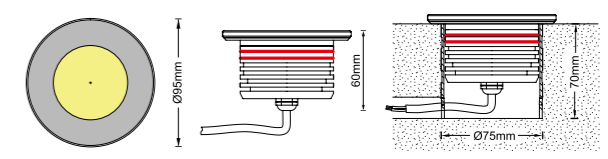
CE RoHS COMPLIANT IP65 IK06

Passivated 1 Year Warranty

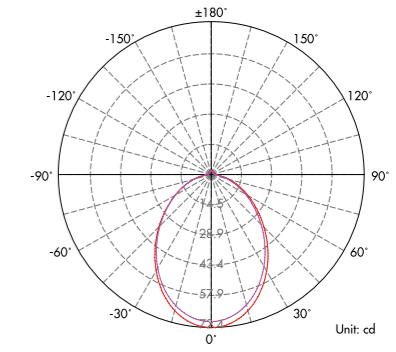
Parameter	
General Data	
Item No.	SP004-1000-A
Power	10 Watts
LED type	12 pcs 3030 LED
Luminous flux	400~450 lm
CCT	2700K, 3000K, 4000K, 6000K, R/G/Y/B
CRI	80+
Beam angle	120°
Dimension	95 x 47 (mm) Diameter x Height
Cut out	75 mm
Net weight	0.313 kgs
Warranty	1 year
Certifications	CE, RoHS
Electrical Data	
Input voltage	DC12V
Insulation class	Class III
Cable	1PC rubber cable 0.3M H05RNF 2x0.75mm square
Driver	Low voltage constant current output, excluding the transformer
Construction Data	
IP rating	IP65 Waterproof
IK rating	IK06
Housing	Solid Passivated (Anodizing) Aluminum CNC machined
Protection finishing	20~25µm thickness anodized film for housing. Dark grey
Trim	Frosted Tempered Glass.
Glass	Tempered Glass. T=5mm.
Loading capacity	320 kgs
Cable Gland	PG7 IP67
Gasket	O-ring PMQ silicone seal
Accessories	
Mounting Sleeve	Anti-corrosion PVC. Grey.
Clip	With strong clip as options for ceiling lights application
Packaging	
Inner box size	125*125*95 mm
Carton size	64.3*39*21 cm (30PCS / carton)



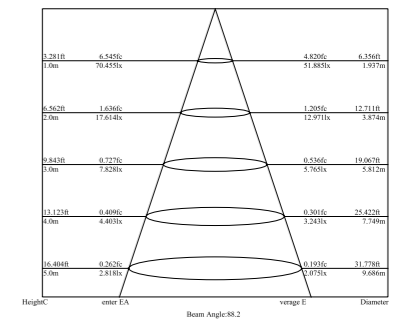
Dimension



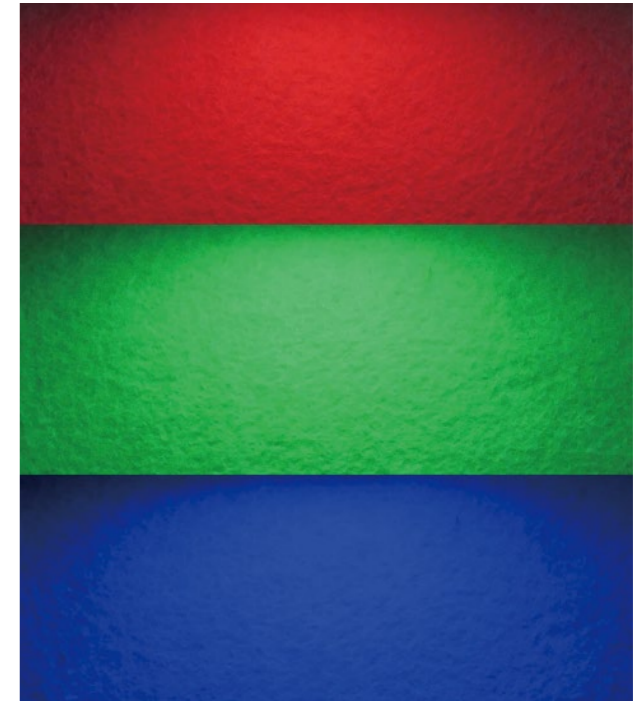
Light Distribution Curve (RGB all LEDs on, 1x120°)



Lux distance Curve (RGB all LEDs on, 1x120°)



Illumination Picture (1x120°)



CE RoHS COMPLIANT IP65 IK06

Passivated 1 Year Warranty

Parameter	
General Data	
Item No.	SP004-1000-RGB-A
Power	10 Watts
LED type	18 pcs 5050 RGB LED
Luminous flux	350 lm (All LEDs on)
CCT	RGB
CRI	70+
Beam angle	120°
Dimension	95 x 60 (mm) Diameter x Height
Cut out	75 mm
Net weight	0.440 kgs
Warranty	1 year
Certifications	CE, RoHS
Electrical Data	
Input voltage	DC12V
Insulation class	Class III
Cable	1PC rubber cable 0.3M H05RNF 4x0.75mm square
Driver	Low voltage constant current output, excluding the transformer
Construction Data	
IP rating	IP65 Waterproof
IK rating	IK06
Housing	Solid Passivated (Anodizing) Aluminum CNC machined
Protection finishing	20~25µm thickness anodized film for housing. Dark grey
Trim	Frosted Tempered Glass
Glass	Tempered Glass. T=5mm.
Loading capacity	320 kgs
Cable Gland	PG9 IP67
Gasket	O-ring PMQ silicone seal
Accessories	
Mounting Sleeve	Anti-corrosion PVC. Grey.
Clip	With strong clip as options for ceiling lights application
Packaging	
Inner box size	125*125*95 mm
Carton size	64.3*39*21 cm (30PCS / carton)

WALL LIGHTS SERIES

WALL LIGHTS SERIES





CE RoHS COMPLIANT IP65 IK06

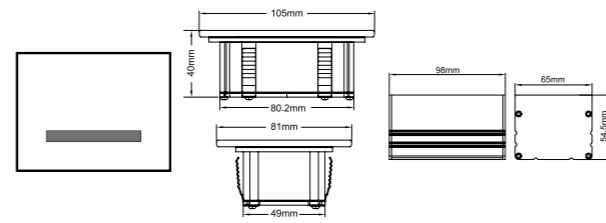
Passivated 1 Year Warranty

Asymmetrical downward beam and black mirror glass!

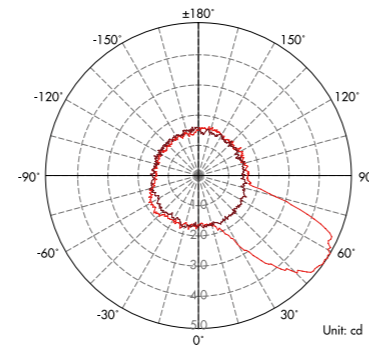
Parameter

General Data	
Item No.	SP-009-0500-BH
Power	5 Watts
LED type	8 PCS OSRAM 3030 LED
Luminous flux	95~120 lm
CCT	2700K, 3000K, 4000K, 6000K
CRI	80+
Beam angle	120° (Asymmetrical downward beam)
Dimension	105x81x40 mm (Length x VWide x Height)
Cut out	98x65x54.5 mm (LxVxH)
Net weight	0.369 kgs
Warranty	1 year
Certifications	CE, RoHS
Electrical Data	
Input voltage	AC100~240V
Insulation class	Class I
Cable	1 x cable 0.3 M.H05RN-F 3x0.75mm square to open wires
Driver	Low voltage constant current output, excluding the transformer
Construction Data	
IP rating	IP65 Waterproof
IK rating	IK06
Housing	Solid Passivated (Anodizing) Aluminum CNC machined
Protection finishing	20~25µm thickness anodized film for housing. Dark grey
Trim	Tempered glass painted in black
Glass	Tempered Glass. T=4mm.
Loading capacity	320 kgs
Cable Gland	PG7 IP67
Gasket	Flat PMQ silicone seal
Accessories	
Mounting Sleeve	Aluminum
Packaging	
Inner box size	130*105*80 mm
Carton size	54x28.5x34 cm (32 PCS items each carton)

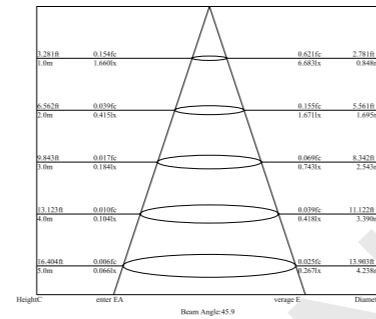
Dimension



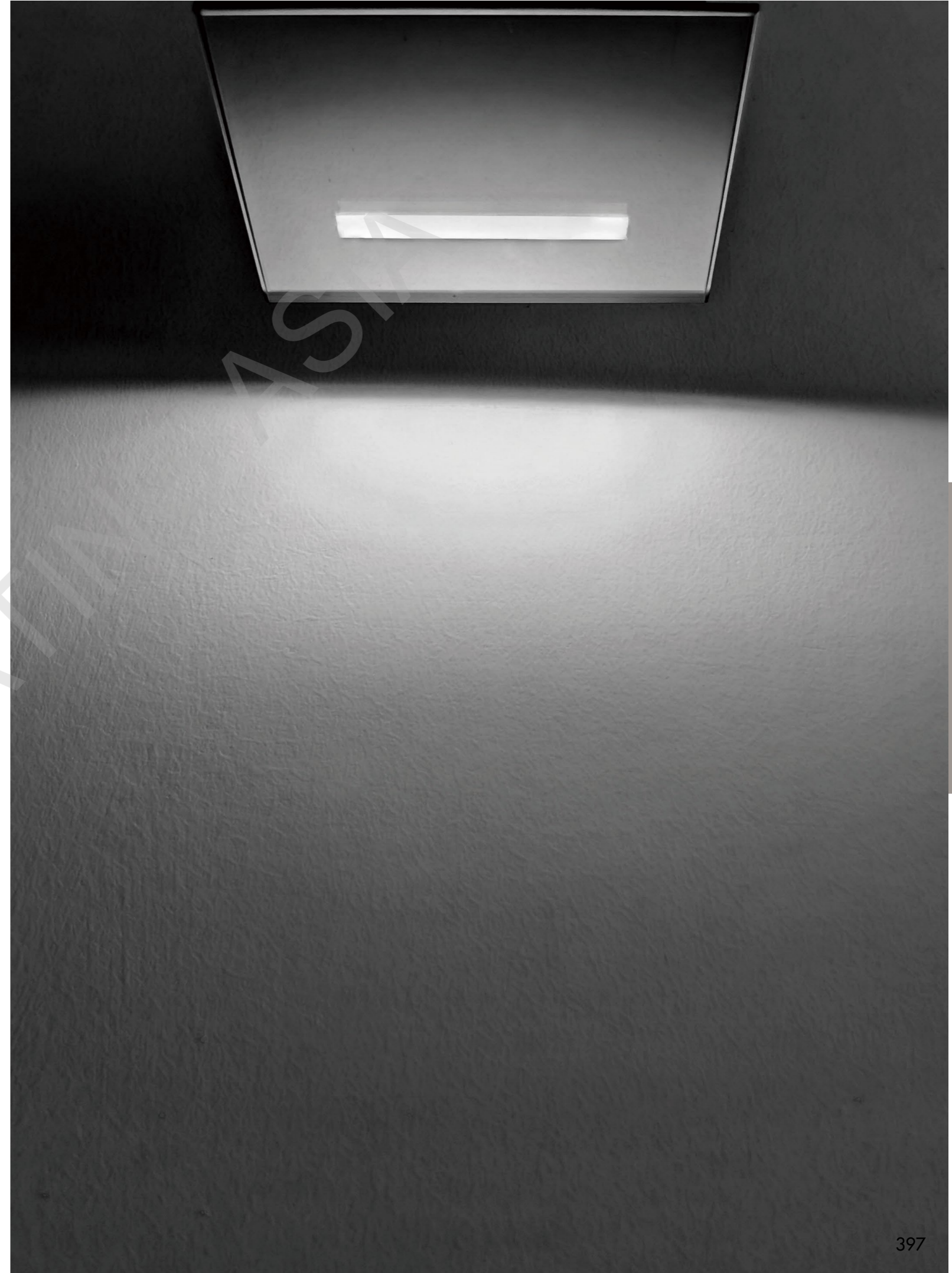
Light Distribution Curve (3000K, 120°)



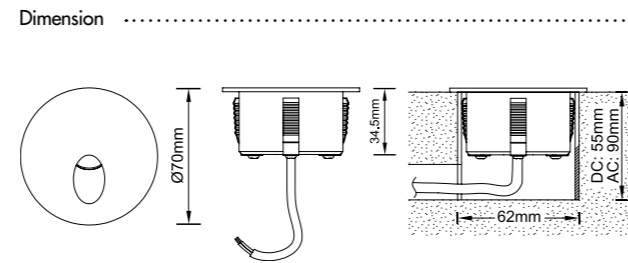
Lux distance Curve (3000K, 120°)



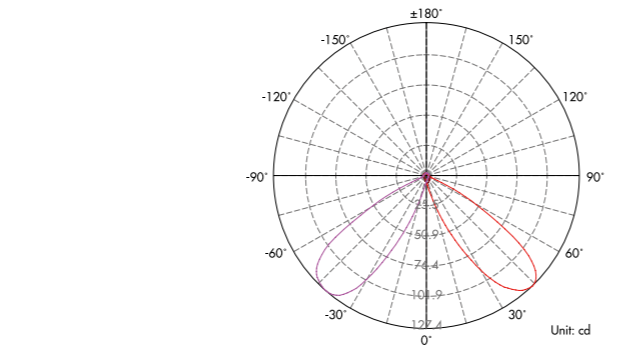
Illumination Picture (120°)



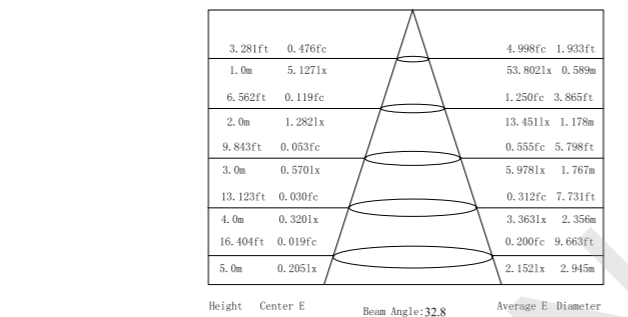




Dimension



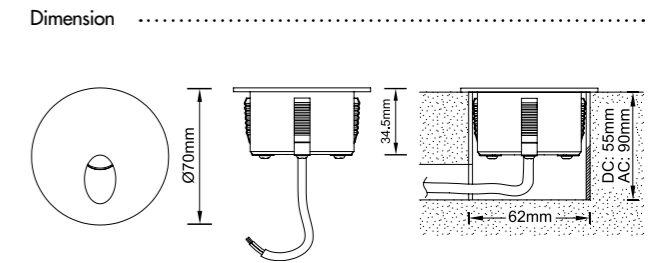
Light Distribution Curve (3000K, 30°)



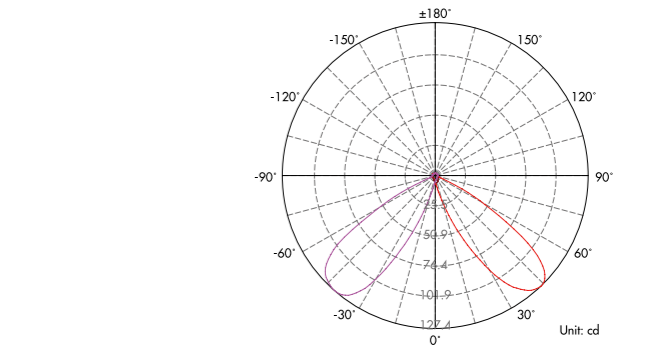
Lux distance Curve (3000K, 30°)



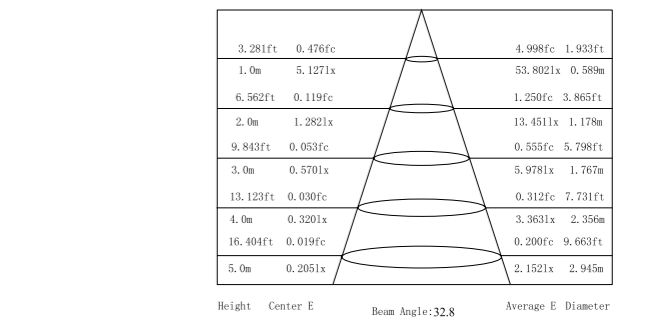
Illumination Picture (30°)



Dimension



Light Distribution Curve (3000K, 30°)



Lux distance Curve (3000K, 30°)



Illumination Picture (30°)

CE RoHS COMPLIANT IP67 IK06

1 Year Warranty



Replaceable LED module!

Parameter

General Data	
Item No.	DC: SP-006-0300-A PC / AC: SP-006-0300-AH PC
Power	3 Watts
LED type	1 PC CREE XPE LED (WWW, NWW, CW. 1 Watt to 3 Watt optional)
Luminous flux	110~130lm
CCT	2700K, 3000K, 4000K, 6000K
CRI	80+
Beam angle	30°
Dimension	70 x 34.5 (mm) Diameter x Height
Cut out	62 mm
Net weight	0.225 kgs
Warranty	1 year
Certifications	CE, RoHS
Electrical Data	
Input voltage	DC 12V/DC24V (AC 100~265V optional)
Insulation class	Class III
Cable	1 x cable 0.3 M H05RN-F 2x0.5mm square to open wires
Driver	Low voltage constant current output, excluding the transformer. (With separately driver for options)
Construction Data	
IP rating	IP65 Waterproof
IK rating	IK06
Housing	Polished chrome Aluminium
Protection finishing	Polished chrome
Trim	Polished chrome Aluminium
Glass	Tempered glass
Loading capacity	320 kgs
Cable Gland	IP65 Aluminium part
Gasket	O-ring PMQ silicone seal
Accessories	
Mounting Sleeve	Anti-corrosion PVC. Grey.
Packaging	
Inner box size	85*85*100 mm
Carton size	27*27*24.5 cm (18PCS items each carton)

CE RoHS COMPLIANT IP67 IK06

1 Year Warranty



Replaceable LED module!

Parameter

General Data	
Item No.	DC: SP-006-0300-A SN / AC: SP-006-0300-AH SN
Power	3 Watts
LED type	1 PC CREE XPE LED (WWW, NWW, CW. 1 Watt to 3 Watt optional)
Luminous flux	110~130lm
CCT	2700K, 3000K, 4000K, 6000K
CRI	80+
Beam angle	30°
Dimension	70 x 34.5 (mm) Diameter x Height
Cut out	62 mm
Net weight	0.225 kgs
Warranty	1 year
Certifications	CE, RoHS
Electrical Data	
Input voltage	DC 12V/DC24V (AC 100~265V optional)
Insulation class	Class III
Cable	1 x cable 0.3 M H05RN-F 2x0.5mm square to open wires
Driver	Low voltage constant current output, excluding the transformer (With separately driver for options)
Construction Data	
IP rating	IP65 Waterproof
IK rating	IK06
Housing	Satin Nickel Aluminium
Protection finishing	Satin Nickel
Trim	Satin Nickel Aluminium
Glass	Tempered glass
Loading capacity	320 kgs
Cable Gland	IP65 Aluminium part
Gasket	O-ring PMQ silicone seal
Accessories	
Mounting Sleeve	Anti-corrosion PVC. Grey.
Packaging	
Inner box size	85*85*100 mm
Carton size	27*27*24.5 cm (18PCS items each carton)



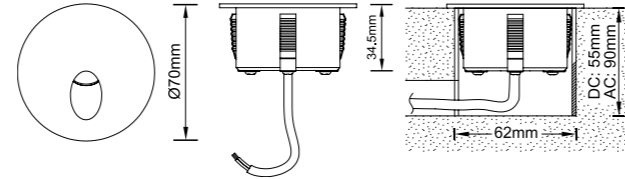
CE RoHS COMPLIANT IP67 IK06

1 Year Warranty

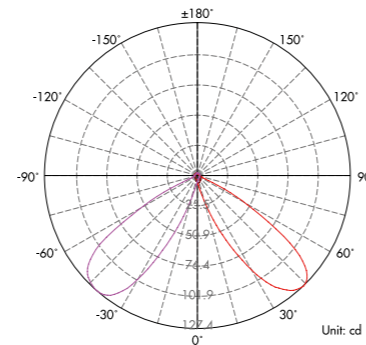


Parameter	
General Data	
Item No.	DC: SP-006-0300-A PW / AC: SP-006-0300-AH PW
Power	3 Watts
LED type	1 PC CREE XPE LED (WWW, NW, CW.1 Watt to 3 Watt optional)
Luminous flux	110~130lm
CCT	2700K, 3000K, 4000K, 6000K
CRI	80+
Beam angle	30°
Dimension	70 x 34.5 (mm) Diameter x Height
Cut out	62 mm
Net weight	0.225 kgs
Warranty	1 year
Certifications	CE, RoHS
Electrical Data	
Input voltage	DC 12V/DC24V (AC100~265V optional)
Insulation class	Class III
Cable	1 x cable 0.3 M H05RN-F 2x0.5mm square to open wires
Driver	Low voltage constant current output, excluding the transformer (With separately driver for options)
Construction Data	
IP rating	IP65 Waterproof
IK rating	IK06
Housing	Powder coated painting in white color Aluminium
Protection finishing	Powder coated painting in white color
Trim	Powder coated painting in white color Aluminium
Glass	Tempered glass
Loading capacity	320 kgs
Cable Gland	IP65 Aluminium part
Gasket	O-ring PMQ silicone seal
Accessories	
Mounting Sleeve	Anti-corrosion PVC. Grey.
Packaging	
Inner box size	85*85*100 mm
Carton size	27*27*24.5 cm (18PCS items each carton)

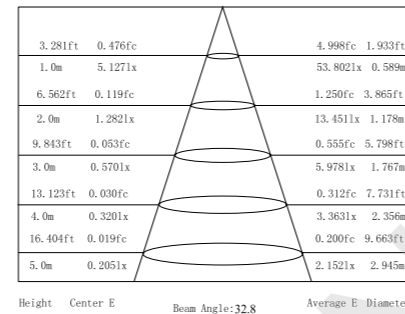
Dimension



Light Distribution Curve (3000K, 30°)



Lux distance Curve (3000K, 30°)



Illumination Picture (30°)



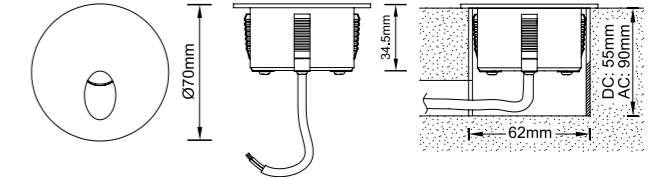
CE RoHS COMPLIANT IP65 IK06

1 Year Warranty

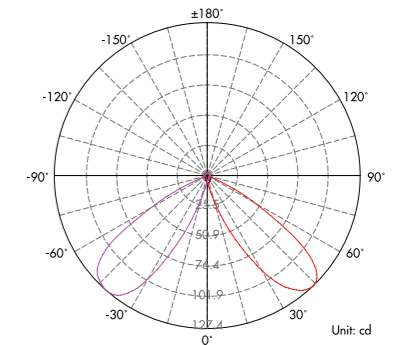


Parameter	
General Data	
Item No.	DC: SP-006-0300-A (Black) / AC: SP-006-0300-AH (Black)
Power	3 watts
LED type	1 PC CREE XPE LED
Luminous flux	110~130 lm
CCT	2700K, 3000K, 4000K, 6000K
CRI	80+
Beam angle	30°
Dimension	70 x 34.5 (mm) Diameter x Height
Cut out	62 mm
Net weight	0.225 kgs
Warranty	1 year
Certifications	CE, RoHS
Electrical Data	
Input voltage	AC100~240V (DC12V / DC24V as options)
Insulation class	Class III
Cable	1 x cable 0.3 M H05RN-F 2x0.5mm square to open wires
Driver	Low voltage constant current output, excluding the transformer (With separately driver for options)
Construction Data	
IP rating	IP65 Waterproof
IK rating	IK06
Housing	Powder coated painting in black color Aluminium
Protection finishing	Powder coated painting in black color
Trim	Powder coated painting in black color Aluminium
Glass	Tempered glass
Loading capacity	320 kgs
Cable Gland	IP67
Gasket	O-ring PMQ silicone seal
Accessories	
Mounting Sleeve	Anti-corrosion PVC. Grey.
Packaging	
Inner box size	85*85*100 mm
Carton size	27*27*24.5 cm (18PCS items each carton)

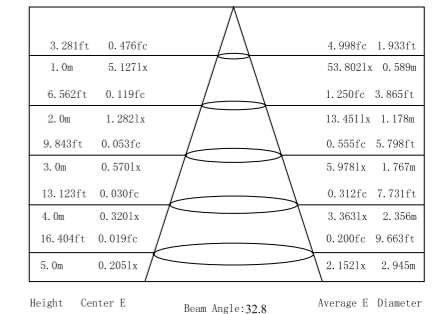
Dimension



Light Distribution Curve (3000K, 30°)



Lux distance Curve (3000K, 30°)

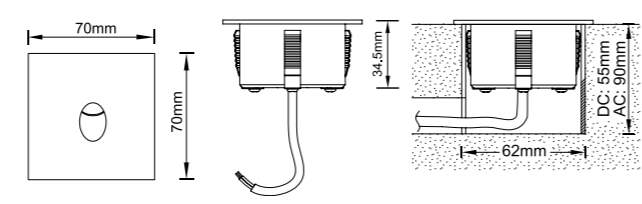


Illumination Picture (30°)

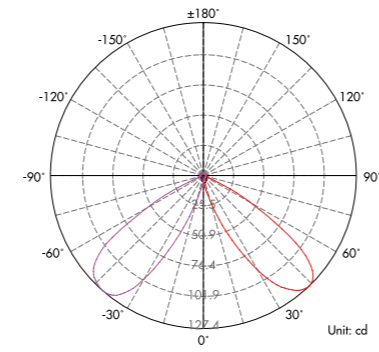




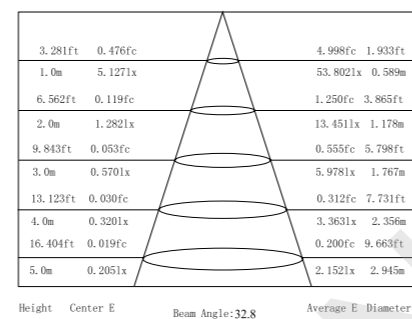
Dimension



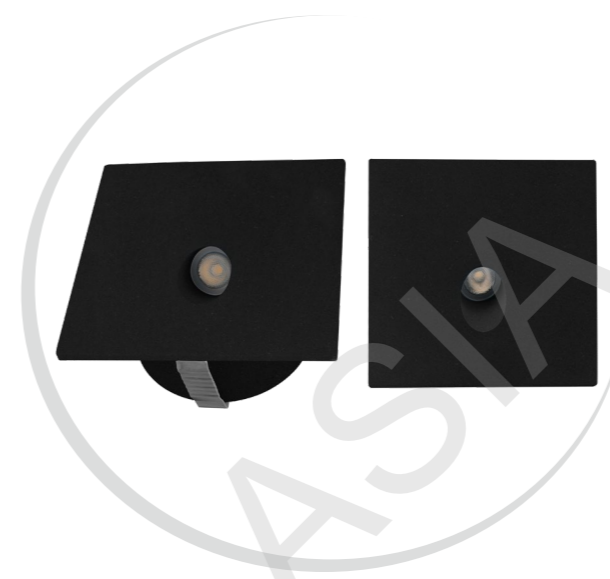
Light Distribution Curve (3000K, 30°)



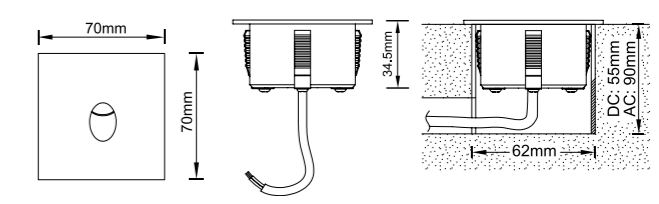
Lux distance Curve (3000K, 30°)



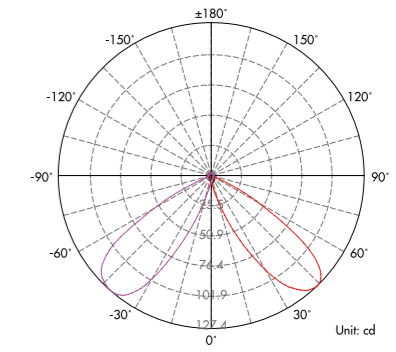
Illumination Picture (30°)



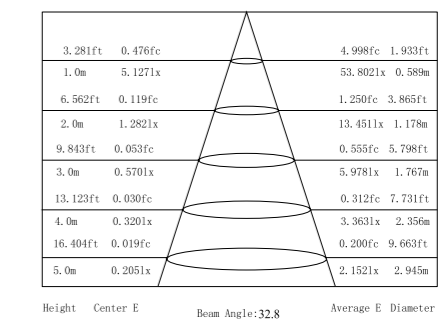
Dimension



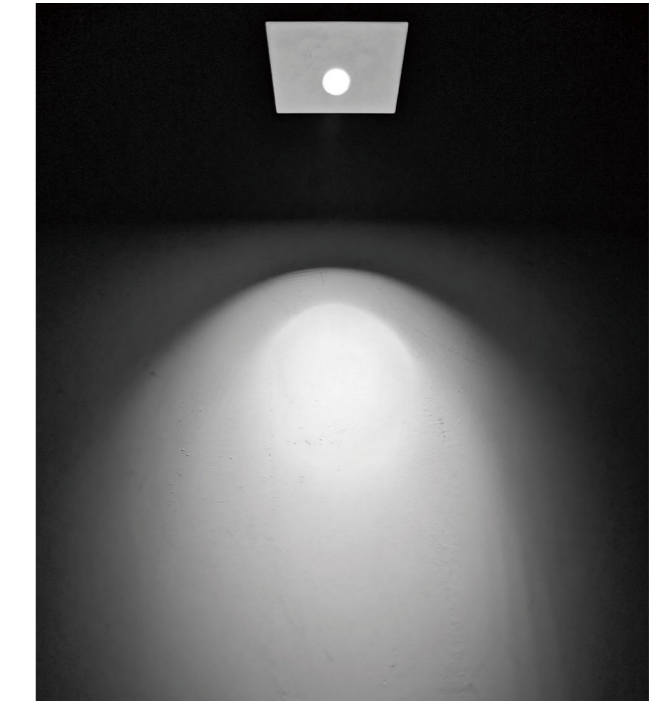
Light Distribution Curve (3000K, 30°)



Lux distance Curve (3000K, 30°)

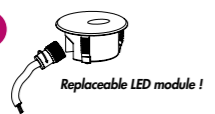


Illumination Picture (30°)



CE RoHS COMPLIANT IP65 IK06

1 Year Warranty



Parameter	
General Data	
Item No.	DC: SP-006-S-0300-A (White) / AC: SP-006-S-0300-AH (White)
Power	3 watts
LED type	1 PC CREE XPE LED
Luminous flux	110~130 lm
CCT	2700K, 3000K, 4000K, 6000K
CRI	80+
Beam angle	30°
Dimension	70 x 70 x 34.5 (mm) Diameter x Height
Cut out	62 mm
Net weight	0.225 kgs
Warranty	1 year
Certifications	CE, RoHS
Electrical Data	
Input voltage	AC100~240V (DC12V / DC24V as options)
Insulation class	Class III
Cable	1 x cable 0.3 M H05RN-F 2x0.5mm square to open wires
Driver	Low voltage constant current output, excluding the transformer (With separately driver for options)
Construction Data	
IP rating	IP65 Waterproof
IK rating	IK06
Housing	Powder coated painting in white color Aluminium
Protection finishing	Powder coated painting in white color
Trim	Powder coated painting in white color Aluminium
Glass	Tempered glass
Loading capacity	320 kgs
Cable Gland	IP67
Gasket	O-ring PMQ silicone seal
Accessories	
Mounting Sleeve	Anti-corrosion PVC. Grey.
Packaging	
Inner box size	85*85*100 mm
Carton size	27*27*24.5 cm (18PCS items each carton)

CE RoHS COMPLIANT IP65 IK06

1 Year Warranty



Parameter	
General Data	
Item No.	DC: SP-006-S-0300-AH (Black) / AC: SP-006-S-0300-AH (Black)
Power	3 watts
LED type	1 PC CREE XPE LED
Luminous flux	110~130 lm
CCT	2700K, 3000K, 4000K, 6000K
CRI	80+
Beam angle	30°
Dimension	70 x 70 x 34.5 (mm) Diameter x Height
Cut out	62 mm
Net weight	0.225 kgs
Warranty	1 year
Certifications	CE, RoHS
Electrical Data	
Input voltage	AC100~240V (DC12V / DC24V as options)
Insulation class	Class III
Cable	1 x cable 0.3 M H05RN-F 2x0.5mm square to open wires
Driver	Low voltage constant current output, excluding the transformer (With separately driver for options)
Construction Data	
IP rating	IP65 Waterproof
IK rating	IK06
Housing	Powder coated painting in black color Aluminium
Protection finishing	Powder coated painting in black color
Trim	Powder coated painting in black color Aluminium
Glass	Tempered glass
Loading capacity	320 kgs
Cable Gland	IP67
Gasket	O-ring PMQ silicone seal
Accessories	
Mounting Sleeve	Anti-corrosion PVC. Grey.
Packaging	
Inner box size	85*85*100 mm
Carton size	27*27*24.5 cm (18PCS items each carton)

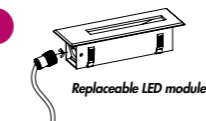
WALL LIGHTS SERIES

WALL LIGHTS SERIES



CE RoHS COMPLIANT IP67 IK06

1 Year Warranty



Parameter

General Data

Item No.	DC: SP007-0300-A PC / AC: SP007-0300-AH PC
Power	3 Watts
LED type	1 PC CREE XPE LED
Luminous flux	110~130 lm
CCT	2700K, 3000K, 4000K, 6000K
CRI	80+
Beam angle	30°
Dimension	170 x 55 x 41.5 (mm) Diameter x Width x Height
Cut out	158 x 50 x 68 (mm) (Length x Width x Height)
Net weight	0.365 kgs
Warranty	1 year
Certifications	CE, RoHS

Electrical Data

Input voltage	DC12V/DC24V (AC100~265V optional)
Insulation class	Class III
Cable	1 x cable 0.3 M H05RN-F 2x0.5mm square to open wires
Driver	Low voltage constant current output, excluding the transformer (With separately driver for options)

Construction Data

IP rating	IP65 Waterproof
IK rating	IK06
Housing	Polished chrome Aluminium
Protection finishing	Polished chrome
Trim	Polished chrome Aluminium
Glass	Tempered glass
Loading capacity	320 kgs
Cable Gland	IP65 Aluminium part
Gasket	O-ring PMQ silicone seal

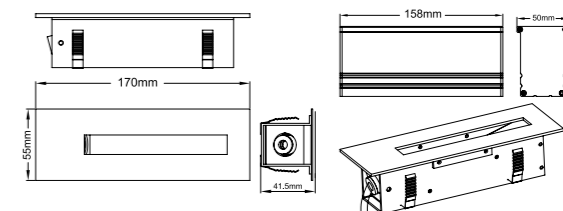
Accessories

Mounting Sleeve	Aluminium box in dark grey
-----------------	----------------------------

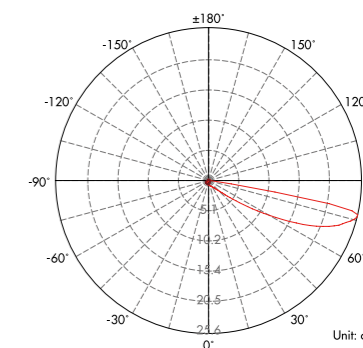
Packaging

Inner box size	185*70*70 mm
Carton size	39.5*37.5*16.5 cm (10 PCS items each carton)

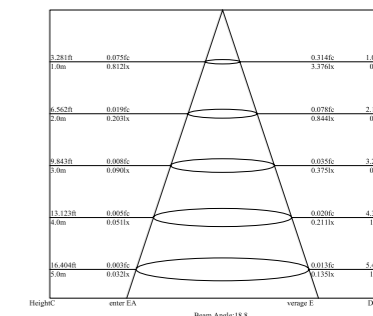
Dimension



Light Distribution Curve (3000K, 30°)



Lux distance Curve (3000K, 30°)

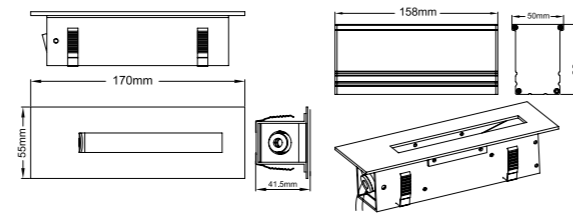


Illumination Picture (30°)

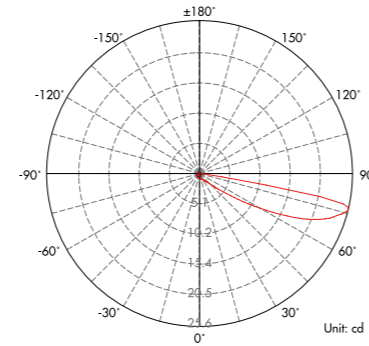




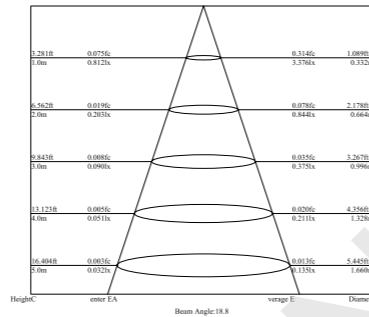
Dimension



Light Distribution Curve (3000K, 30°)



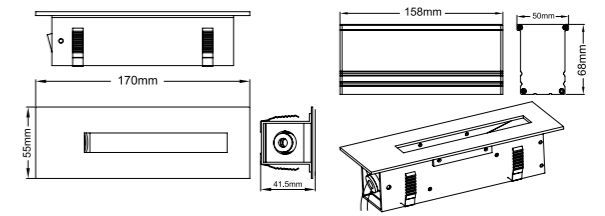
Lux distance Curve (3000K, 30°)



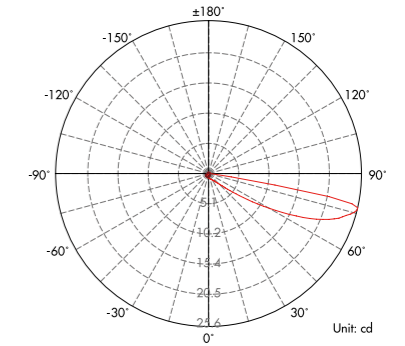
Illumination Picture (30°)



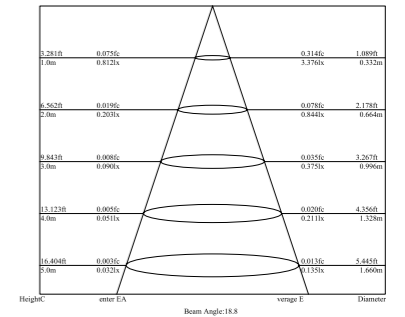
Dimension



Light Distribution Curve (3000K, 30°)



Lux distance Curve (3000K, 30°)

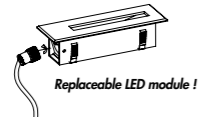


Illumination Picture (30°)



CE RoHS COMPLIANT IP67 IK06

1 Year Warranty

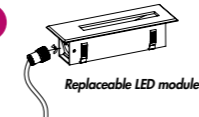


Parameter

General Data	
Item No.	DC: SP-007-0300A SN / AC: SP-007-0300AH SN
Power	3 Watts
LED type	1 PC CREE XPE LED
Luminous flux	110~130 lm
CCT	2700K, 3000K, 4000K, 6000K
CRI	80+
Beam angle	30°
Dimension	170 x 55 x 41.5 (mm) Diameter x Width x Height
Cut out	158 x 50 x 68 (mm) (Length x Width x Height)
Net weight	0.365 kgs
Warranty	1 year
Certifications	CE, RoHS
Electrical Data	
Input voltage	DC 12V/DC24V (AC100~265V optional)
Insulation class	Class III
Cable	1 x cable 0.3 M H05RN-F 2x0.5mm square to open wires
Driver	Low voltage constant current output, excluding the transformer (With separately driver for options)
Construction Data	
IP rating	IP65 Waterproof
IK rating	IK06
Housing	Satin Nickel Aluminium
Protection finishing	Satin Nickel
Trim	Satin Nickel Aluminium
Glass	Tempered glass
Loading capacity	320 kgs
Cable Gland	IP65 Aluminium part
Gasket	O-ring PMQ silicone seal
Accessories	
Mounting Sleeve	Aluminium box in dark grey
Packaging	
Inner box size	185*70*70 mm
Carton size	39.5*37.5*16.5 cm (10 PCS items each carton)

CE RoHS COMPLIANT IP67 IK06

1 Year Warranty



Parameter

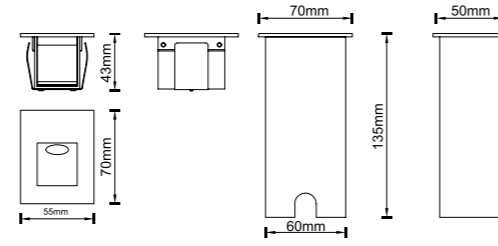
General Data	
Item No.	DC: SP-007-0300-A PW / AC: SP-007-0300-AH PW
Power	3 Watts
LED type	1 PC CREE XPE LED
Luminous flux	110~130 lm
CCT	2700K, 3000K, 4000K, 6000K
CRI	80+
Beam angle	30°
Dimension	170 x 55 x 41.5 (mm) Diameter x Width x Height
Cut out	158 x 50 x 68 (mm) (Length x Width x Height)
Net weight	0.365 kgs
Warranty	1 year
Certifications	CE, RoHS
Electrical Data	
Input voltage	DC 12V/DC24V (AC100~265V optional)
Insulation class	Class III
Cable	1 x cable 0.3 M H05RN-F 2x0.5mm square to open wires
Driver	Low voltage constant current output, excluding the transformer (With separately driver for options)
Construction Data	
IP rating	IP65 Waterproof
IK rating	IK06
Housing	Powder coated painting in white color Aluminium
Protection finishing	Powder coated painting in white color
Trim	Powder coated painting in white color Aluminium
Glass	Tempered glass
Loading capacity	320 kgs
Cable Gland	IP65 Aluminium part
Gasket	O-ring PMQ silicone seal
Accessories	
Mounting Sleeve	Aluminium box in dark grey
Packaging	
Inner box size	185*70*70 mm
Carton size	39.5*37.5*16.5 cm (10 PCS items each carton)



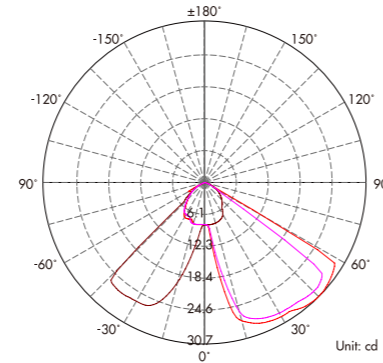
Dawn Mini PC



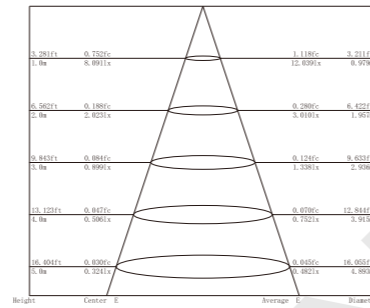
Dimension



Light Distribution Curve (3000K, 40°x45°)



Lux distance Curve (3000K, 40°x45°)



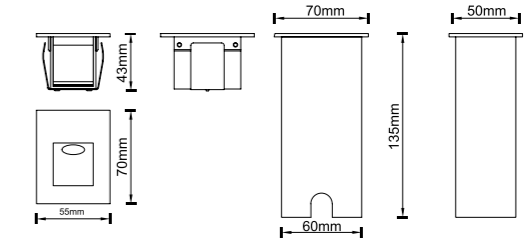
Illumination Picture (40°x45°)



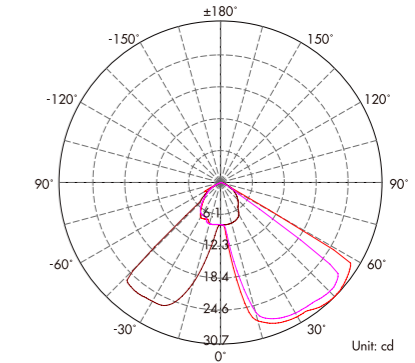
Dawn Mini PW



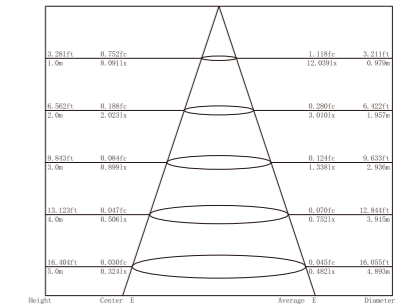
Dimension



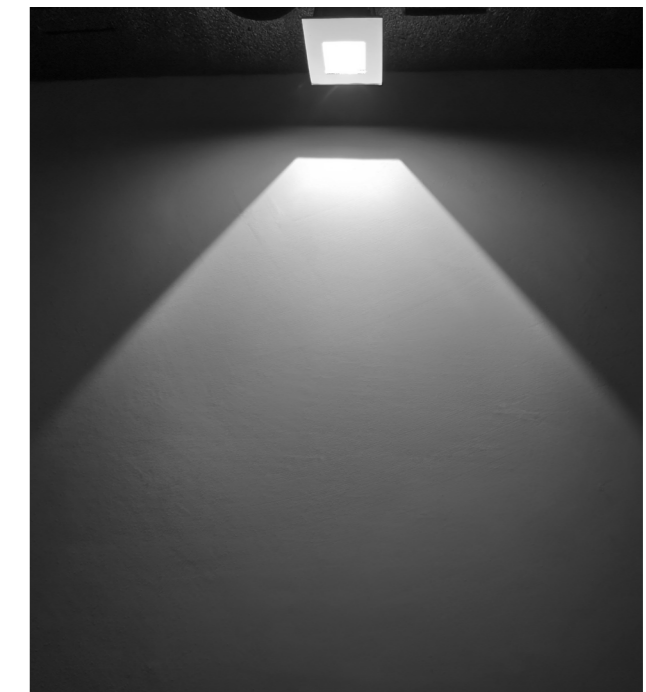
Light Distribution Curve (3000K, 40°x45°)



Lux distance Curve (3000K, 40°x45°)



Illumination Picture (40°x45°)



CE RoHS COMPLIANT IP65 IK06

1 Year Warranty

Personally customized!

Parameter

General Data	
Item No.	SP015-0100-AH-PC
Power	1 Watts +10%
LED type	1 PC OSRAM 3030 LED
Luminous flux	40 lm +10%
CCT	2700K, 3000K, 4000K, 4500K, 5700K, 6500K
CRI	80+
Beam angle	Asymmetrical 40°x 45°
Dimension	70*55*43 mm (Length x Width x Height)
Cut out	60*50*135 mm (Length x Width x Height)
Net weight	0.35 kgs
Warranty	1 year
Certifications	CE, RoHS
Electrical Data	
Input voltage	AC100-265V (DC12-24V optional)
Insulation class	Class I
Cable	PVC cable 0.5M 2x0.34 mm square
Driver	constant current driver
Construction Data	
IP rating	IP65 Waterproof
IK rating	IK06
Housing	Aluminium
Protection finishing	Powder coated painted in white for housing
Trim	polished chrome Aluminium
Glass	Tempered glass
Loading capacity	/
Cable Gland	Aluminium part IP65
Gasket	silicone ring + silicone glue seal
Accessories	
Mounting box	Aluminium mounting box
Packaging	
Inner box size	/ mm
Carton size	/ cm (/ PCS/carton)

CE RoHS COMPLIANT IP65 IK06

1 Year Warranty

Personally customized!

Parameter

General Data	
Item No.	SP015-0100-AH-PW
Power	1 Watts +10%
LED type	1 PC OSRAM 3030 LED
Luminous flux	40 lm +10%
CCT	2700K, 3000K, 4000K, 4500K, 5700K, 6500K
CRI	80+
Beam angle	Asymmetrical 40°x 45°
Dimension	70*55*43 mm (Length x Width x Height)
Cut out	60*50*135 mm (Length x Width x Height)
Net weight	0.35 kgs
Warranty	1 year
Certifications	CE, RoHS
Electrical Data	
Input voltage	AC100-265V (DC12-24V optional)
Insulation class	Class I
Cable	PVC cable 0.5M 2x0.34 mm square
Driver	constant current driver
Construction Data	
IP rating	IP65 Waterproof
IK rating	IK06
Housing	Aluminium
Protection finishing	Powder coated painted in white for housing
Trim	Powder coated painted in white Aluminium (Black as options)
Glass	Tempered glass
Loading capacity	/
Cable Gland	Aluminium part IP65
Gasket	silicone ring + silicone glue seal
Accessories	
Mounting box	Aluminium mounting box
Packaging	
Inner box size	/ mm
Carton size	/ cm (/ PCS/carton)

Dawn Mini SN



CE RoHS COMPLIANT IP65 IK06

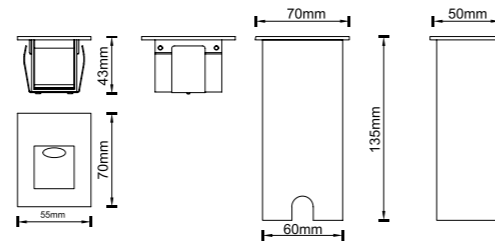
1 Year Warranty

Personally customized!

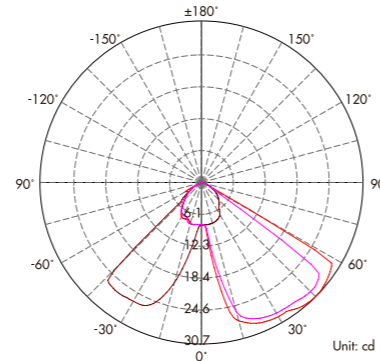
Parameter

General Data	
Item No.	SP0150100-AH SN
Power	1 Watts +10%
LED type	1 PC OSRAM 3030 LED
Luminous flux	40 lm +10%
CCT	2700K, 3000K, 4000K, 4500K, 5700K, 6500K
CRI	80+
Beam angle	Asymmetrical 40°x 45°
Dimension	70*55*43 mm (Length x Width x Height)
Cut out	60*50*135 mm (Length x Width x Height)
Net weight	0.35 kgs
Warranty	1 year
Certifications	CE, RoHS
Electrical Data	
Input voltage	AC100-265V (DC12-24V optional)
Insulation class	Class I
Cable	PVC cable 0.5M 2x0.34 mm square
Driver	constant current driver
Construction Data	
IP rating	IP65 Waterproof
IK rating	IK06
Housing	Aluminium
Protection finishing	Powder coated painted in white for housing
Trim	satn nickel plating Aluminium
Glass	Tempered glass
Loading capacity	/
Cable Gland	Aluminium part IP65
Gasket	silicone ring + silicone glue seal
Accessories	
Mounting box	Aluminium mounting box
Packaging	
Inner box size	/ mm
Carton size	/ cm [/ PCS/carton]

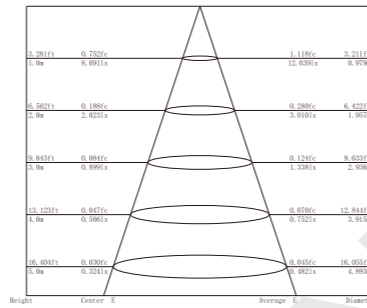
Dimension



Light Distribution Curve (3000K, 40°x45°)



Lux distance Curve (3000K, 40°x45°)



Illumination Picture (40°x45°)



Shadow S3



CE RoHS COMPLIANT IP67 IK06

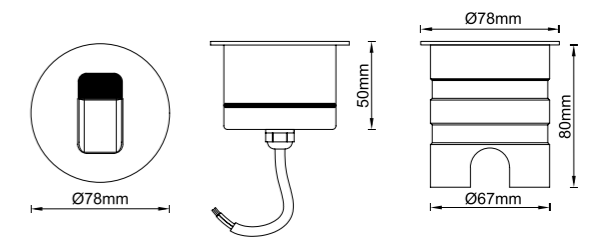
1 Year Warranty

SS316 trim or Aluminium trim
Used as inground light or wall light

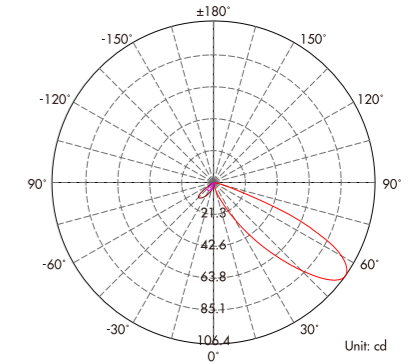
Parameter

General Data	
Item No.	SP0160300-A
Power	1 Watts +10%
LED type	1 PC OSRAM 3030 LED
Luminous flux	40 lm +10%
CCT	2700K, 3000K, 4000K, 4500K, 5700K, 6500K
CRI	80+
Beam angle	15°, 20°, 25°, 30°, 38°, 45°, 60°
Dimension	Ø78*50 mm (Diameter x Height)
Cut out	Ø67mm
Net weight	0.5 kgs
Warranty	1 year
Certifications	CE, RoHS
Electrical Data	
Input voltage	DC12-24V (AC100-265V optional)
Insulation class	Class III
Cable	1 PC rubber cable 1M H05RN-F 2 or 3x1mm square
Driver	low constant voltage input, constant current output for LED
Construction Data	
IP rating	IP65 Waterproof
IK rating	IK06
Housing	Aluminium CNC machined
Protection finishing	Anodized +Powder coated painted in dark grey for housing
Trim	Dark grey Aluminium trim or stainless steel 316 trim as options
Glass	Tempered glass
Loading capacity	/
Cable Gland	PG Gland IP67
Gasket	silicone ring + silicone glue seal
Accessories	
Mounting box	Aluminium mounting sleeve
Packaging	
Inner box size	/ mm
Carton size	/ cm [/ PCS/carton]

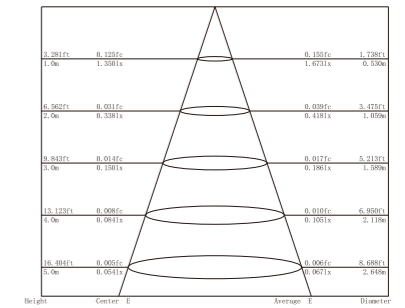
Dimension



Light Distribution Curve (3000K, 30°)



Lux distance Curve (3000K, 30°)



Illumination Picture (30°)









CE RoHS COMPLIANT IP67 IK08

SSS 316 1 Year Warranty

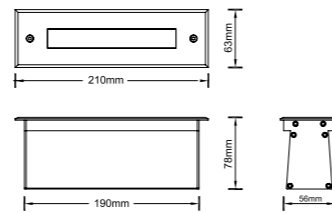
Used as step lights, inground lights!

Asymmetrical downward lens!

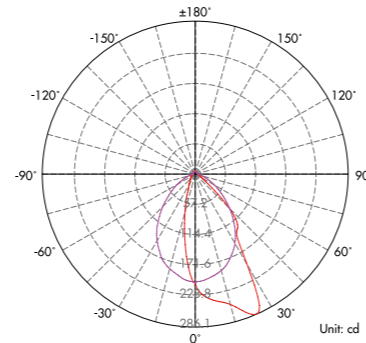
Parameter

General Data	
Item No.	UL-C001-0700-AH
Power	7.5 Watts
LED type	30 PCS OSRAM 2835 SMD LED
Luminous flux	330~350 lm
CCT	2700K, 3000K, 4000K, 6000K, R/G/Y/B
CRI	80+
Beam angle	Asymmetrical 30° tilt +120° pan beam
Dimension	210 x 63 x 78 (mm) Length x Width x Height
Cut out	185 x 57 x 75 (mm) Length x Width x Height
Net weight	1.04 kgs
Warranty	1 year
Certifications	CE, RoHS
Electrical Data	
Input voltage	AC100-255V
Insulation class	Class I
Cable	1PC rubber cable 1M H05RN-F 3x1mm square
Driver	Built-in high voltage constant current driver with transformer
Construction Data	
IP rating	IP67 Waterproof
IK rating	IK08
Housing	Passivated(Anodizing) Aluminum
Protection finishing	20~25µm thickness anodized film for housing. Dark grey
Trim	Stainless steel 316
Glass	Step tempered Glass. T=8mm.
Loading capacity	500 kgs
Cable Gland	PG gland
Gasket	PMQ silicone seal
Accessories	
Mounting Sleeve	Passivated (Anodizing) Aluminum CNC machined. Dark grey
Packaging	
Inner box size	220*85*95 mm
Carton size	44.5*23.5*21 cm (10 PCS / carton)

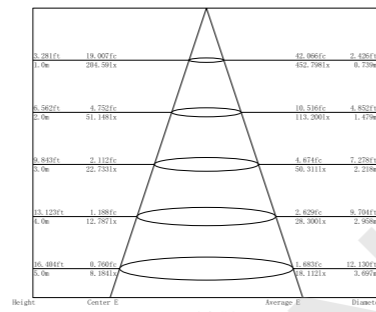
Dimension



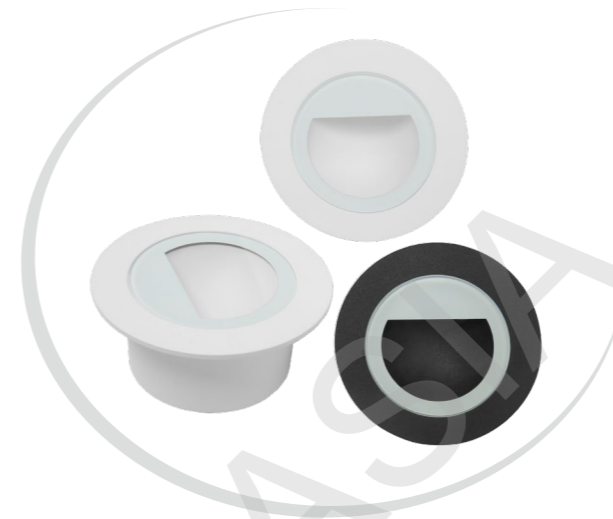
Light Distribution Curve (3000K,30x120°)



Lux distance Curve (3000K,30x120°)



Illumination Picture (30x120°)



CE RoHS COMPLIANT IP65 IK06

SSS 316 1 Year Warranty

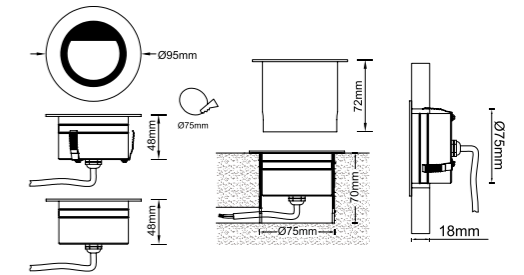
Asymmetrical downward reflector!

Asymmetrical downward lens!

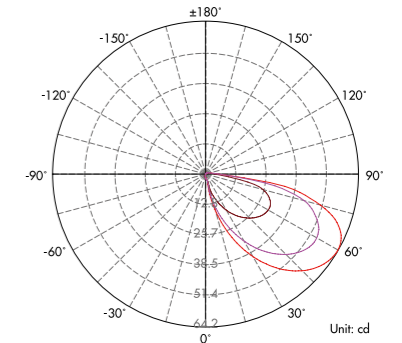
Parameter

General Data	
Item No.	SP-014-0300-A
Power	3 Watts
LED type	3 PCS OSRAM 3030 SMD LED
Luminous flux	80 lm (Black housing version)
CCT	2700K, 3000K, 4000K, 6000K
CRI	80+
Beam angle	Asymmetric 50°x55°
Dimension	95x48 mm (Diameter x Height)
Cut out	Ø75mm
Net weight	0.3 KGS
Warranty	1 year
Certifications	CE, RoHS
Electrical Data	
Input voltage	DC 24V (AC100~265V as optional)
Insulation class	Class III (Class I)
Cable	1PC rubber cable 1M H05RN-F 2 or 3 x 1mm square
Driver	Built-in low voltage constant current driver or high voltage constant current driver
Construction Data	
IP rating	IP65 Waterproof
IK rating	IK06
Housing	Solid Passivated (Anodizing) Aluminum CNC machined
Protection finishing	Powder coated painted in black as standard, white as optional
Trim	Glass+Aluminium
Glass	Step tempered Glass. T=4mm.
Loading capacity	320 kgs
Cable Gland	PG gland
Gasket	PMQ silicone seal
Accessories	
Mounting Sleeve	PVC tube as step light
Clip	With strong clips optional as downlight
Packaging	
Inner box size	/
Carton size	64.3*39*21 (30PCS/CTN)

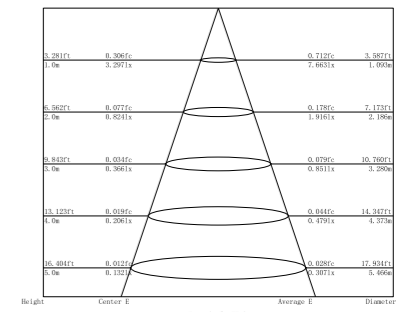
Dimension



Light Distribution Curve (3000K,50°x55°)

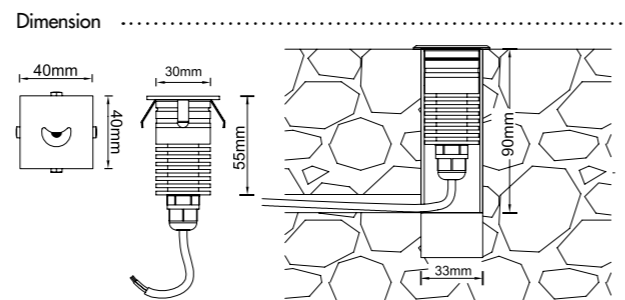


Lux distance Curve (3000K,50°x55°)

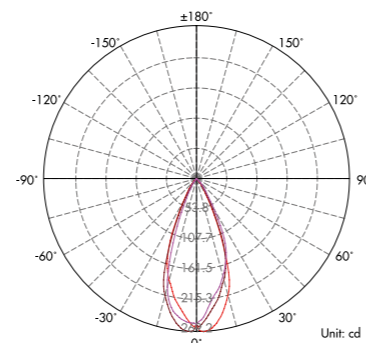


Illumination Picture (50°x55°)

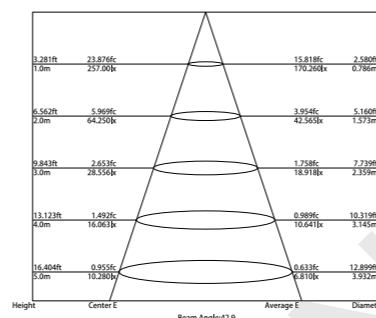




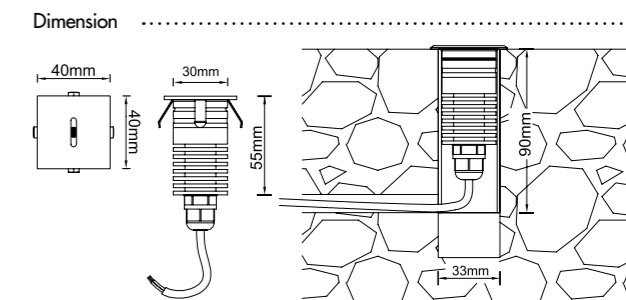
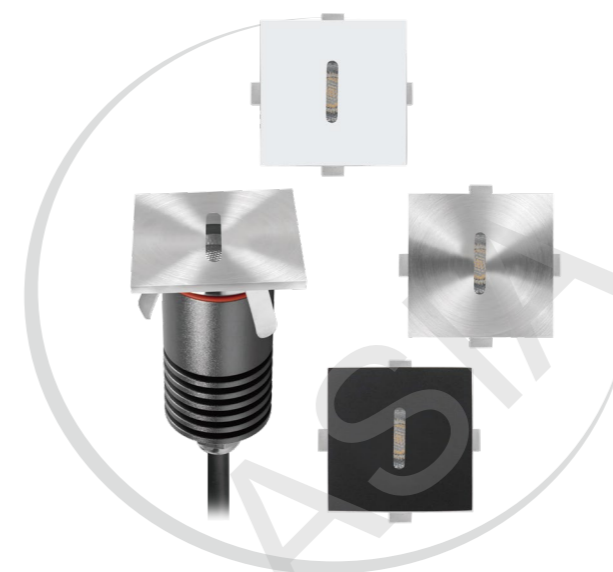
Light Distribution Curve (3000K, 58°)



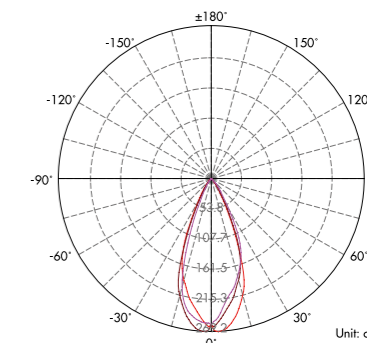
Lux distance Curve (3000K, 58°)



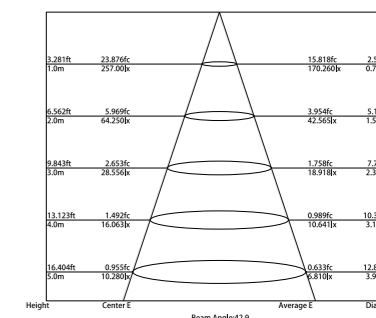
Illumination Picture (58°)



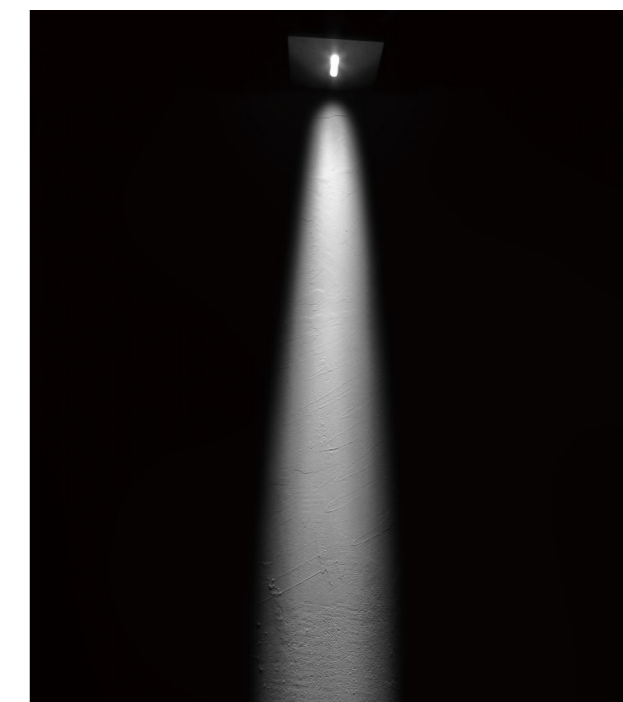
Light Distribution Curve (3000K, 8°)



Lux distance Curve (3000K, 8°)



Illumination Picture (8°)



CE RoHS COMPLIANT IP67 IK09

SSS 316 1 Year Warranty

Used as step lights, inground lights !

Parameter	
General Data	
Item No.	UL-1003-0300-AJC trim)3 Watts
Power	1 PC 3W CREE XPE LED
LED type	40lm±10%
Luminous flux	2700K, 3000K, 4000K, 6000K, R/G/Y/B
CCT	80+
CRI	5°, 10°, 17°, 23°, 28°, 43°, 58°
Beam angle	Ø40x55 (mm) Diameter x length
Dimension	33 mm with sleeve, 37mm with clip
Cut out	0.23 kgs
Net weight	1 year
Warranty	CE, RoHS
Certifications	
Electrical Data	
Input voltage	DC12V ~DC24V
Insulation class	Class III
Cable	1PC rubber cable 1M H05RN-F 2x1mm square
Driver	Low voltage constant current output, excluding the transformer
Construction Data	
IP rating	IP67 Waterproof
IK rating	IK09
Housing	Solid Passivated (Anodizing) Aluminum CNC machined
Protection finishing	20~25µm thickness anodized film for housing. Dark grey
Trim	Stainless steel 316 original color as standard, (painted in black or white as optional)
Glass	Step tempered Glass. T=10mm.
Loading capacity	700 kgs
Cable Gland	PG gland
Gasket	O-ring PMQ silicone seal
Accessories	
Mounting Sleeve	Passivated (Anodizing) Aluminum CNC machined. Dark grey
Clip	With spring as options, that's for wall lights, deck lights or ceiling lights application
Packaging	
Inner box size	110*85*60 mm
Carton size	44*24*32 cm (50 PCS / carton)

CE RoHS COMPLIANT IP67 IK09

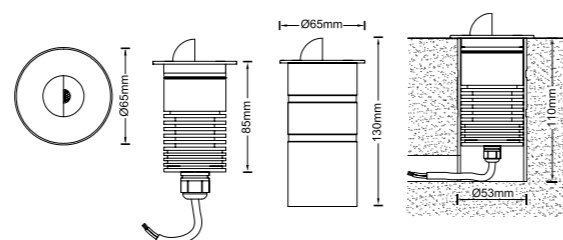
SSS 316 1 Year Warranty

Used as step lights, inground lights !

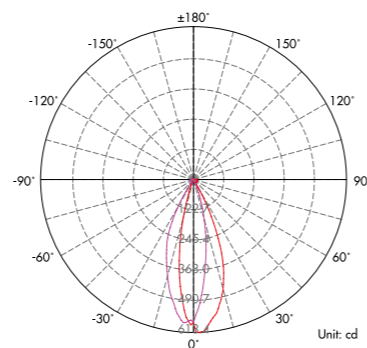
Parameter	
General Data	
Item No.	UL-1003-0300-A(D trim)
Power	3 Watts
LED type	1 PC 3W CREE XPE LED
Luminous flux	30lm±10%
CCT	2700K, 3000K, 4000K, 6000K, R/G/Y/B
CRI	80+
Beam angle	5°
Dimension	Ø40x55 (mm) Diameter x length
Cut out	33 mm with sleeve, 37mm with clip
Net weight	0.23 kgs
Warranty	1 year
Certifications	CE, RoHS
Electrical Data	
Input voltage	DC12V ~DC24V
Insulation class	Class III
Cable	1PC rubber cable 1M H05RN-F 2x1mm square
Driver	Low voltage constant current output, excluding the transformer
Construction Data	
IP rating	IP67 Waterproof
IK rating	IK09
Housing	Solid Passivated (Anodizing) Aluminum CNC machined
Protection finishing	20~25µm thickness anodized film for housing. Dark grey
Trim	Stainless steel 316 original color as standard, (painted in black or white as optional)
Glass	Step tempered Glass. T=10mm.
Loading capacity	700 kgs
Cable Gland	PG gland
Gasket	O-ring PMQ silicone seal
Accessories	
Mounting Sleeve	Passivated (Anodizing) Aluminum CNC machined. Dark grey
Clip	With spring as options, that's for wall lights, deck lights or ceiling lights application
Packaging	
Inner box size	110*85*60 mm
Carton size	44*24*32 cm (50 PCS / carton)



Dimension



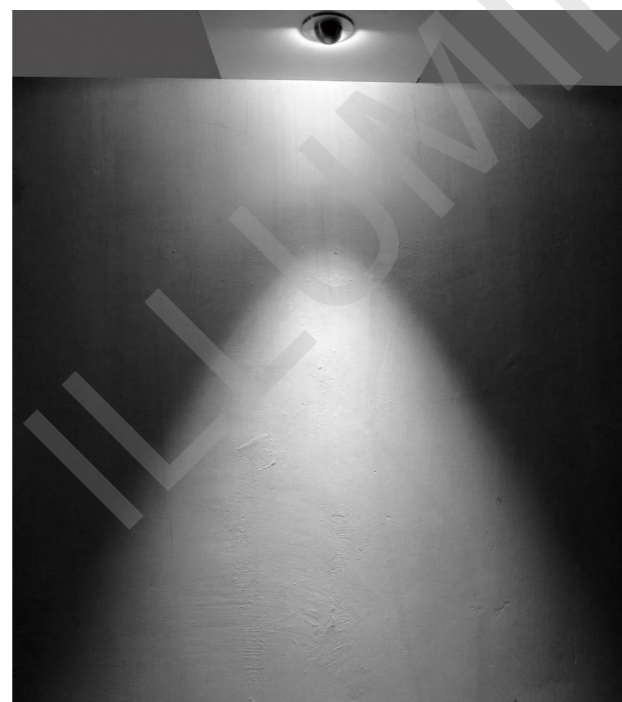
Light Distribution Curve (3000K, 1x24°)



Lux distance Curve (3000K, 1x24°)

Height	Center E	Beam Angle: 31.9	Average E	Diameter
3.281ft	53.069fc		32.999fc	1.873ft
1.0m	571.23lx		355.200lx	0.571m
6.562ft	13.267fc		18.079fc	3.948ft
2.0m	142.81lx		194.603lx	1.203m
9.843ft	5.897fc		8.035fc	5.922ft
3.0m	63.470lx		86.490lx	1.805m
13.123ft	3.317fc		4.520fc	7.897ft
4.0m	35.702lx		48.651lx	2.407m
16.404ft	2.123fc		2.893fc	9.871ft
5.0m	22.849lx		31.136lx	3.009m

Illumination Picture (1x24°)



CE RoHS COMPLIANT IP67 IK08

SSS 316 Passivated 1 Year Warranty

Parameter

General Data	
Item No.	UL-6W-COB-0600-CH (HOOD TRIM)
Power	6 Watts
LED type	1 PC 6W COB LED
Luminous flux	234-300 lm
CCT	2700K, 3000K, 4000K, 6000K
CRI	80+
Beam angle	24°, 36°
Dimension	Ø65x85 (mm) Diameter x length
Cut out	53 mm
Net weight	0.62 kgs
Warranty	1 year
Certifications	CE, RoHS
Electrical Data	
Input voltage	AC100~245V as standard (DC24V as options)
Insulation class	Class I
Cable	1PC rubber cable 1M H05RN-F 3x1mm square
Driver	Built-in high voltage constant current driver with transformer
Construction Data	
IP rating	IP67 Waterproof
IK rating	IK08
Housing	Solid Passivated (Anodizing) Aluminum CNC machined
Protection finishing	20~25µm thickness anodized film for housing. Dark grey
Trim	Stainless steel 316
Glass	Step tempered Glass, T=6mm.
Loading capacity	2000 kgs
Cable Gland	PG9 IP67
Gasket	O-ring PMQ silicone seal
Accessories	
Mounting Sleeve	Passivated (Anodizing) Aluminum CNC machined. Dark grey
Packaging	
Inner box size	117*117*105 mm
Carton size	49*25*23.5 cm (16PCS / carton)





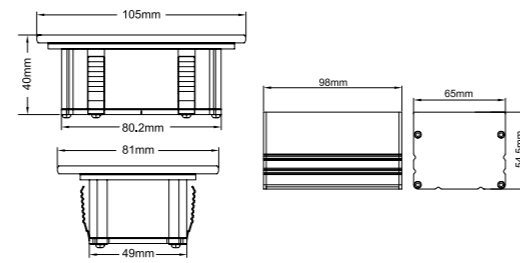
CE RoHS COMPLIANT IP65 IK06

Passivated 1 Year Warranty

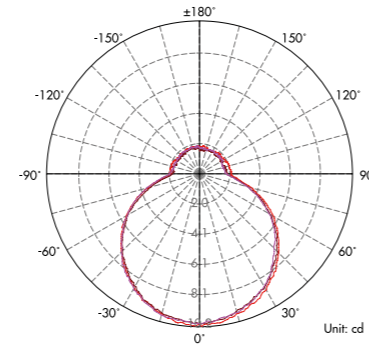
Touched controlled trim!

Parameter	
General Data	
Item No.	SP008-0400-AH-TOUCH
Power	4 Watts
LED type	30 pcs 2835 SMD LED
Luminous flux	100~120 lm
CCT	2700K, 3000K, 4000K, 6000K
CRI	80+
Beam angle	120°
Dimension	105x81x40 mm (Length x Wide x Height)
Cut out	98x65x54.5 mm
Net weight	0.372 kgs
Warranty	1 year
Certifications	CE, RoHS
Electrical Data	
Input voltage	AC100~240V
Insulation class	Class I
Cable	1 x cable 0.3 M H05RN-F 3x0.75mm square to open wires
Driver	Built-in high voltage constant current driver with transformer
Control	Touched controlled for dimming, turning off or on
Construction Data	
IP rating	IP65 Waterproof
IK rating	IK06
Housing	Solid Passivated (Anodizing) Aluminum CNC machined
Protection finishing	20~25µm thickness for housing. Dark grey
Trim	Tempered glass painted in milky white
Glass	tempered Glass, T=4mm.
Loading capacity	320 kgs
Cable Gland	PG7 IP67
Gasket	Flat PMQ silicone seal
Accessories	
Mounting Sleeve	Aluminium
Packaging	
Inner box size	130*105*80 mm
Carton size	54x28.5x34 cm (32 PCS items each carton)

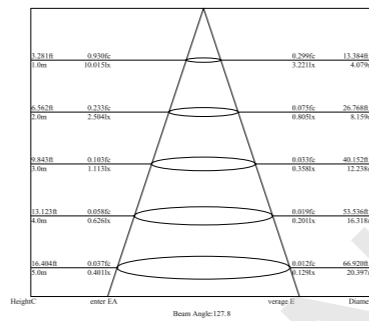
Dimension



Light Distribution Curve (3000K, 120°)

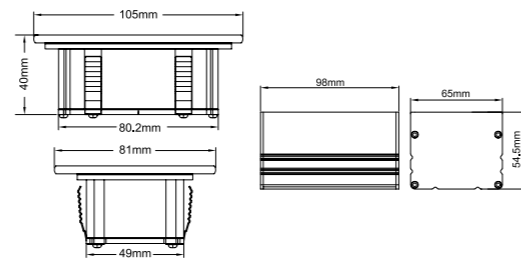


Lux distance Curve (3000K, 120°)

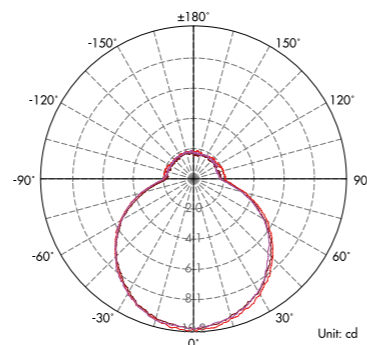




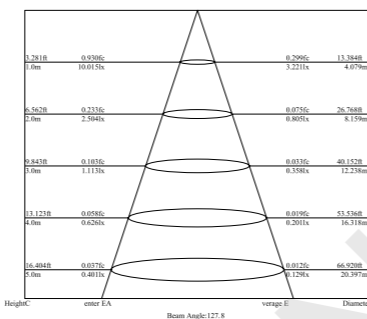
Dimension



Light Distribution Curve (3000K, 120°)



Lux distance Curve (3000K, 120°)



Illumination Picture (120°)



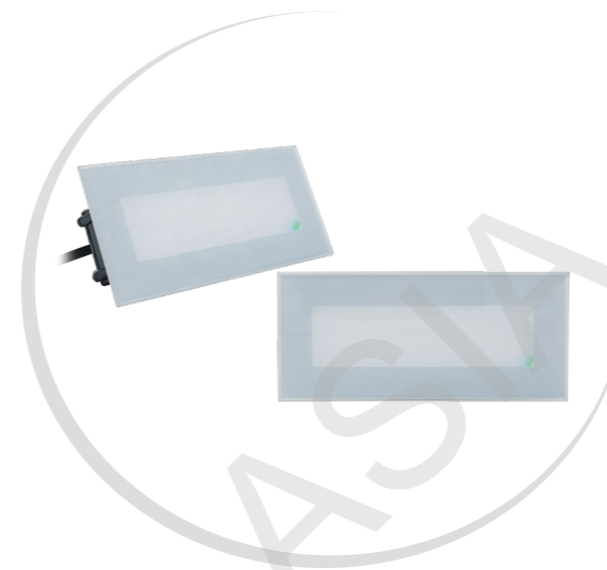
CE RoHS COMPLIANT IP65 IK06

Passivated 1 Years Warranty

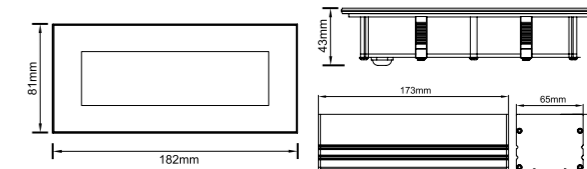
With battery for emergency illumination!
1 PC SP-001-0400-E = 1 PC General Step Light + 1 PC Emergency Light!

Parameter

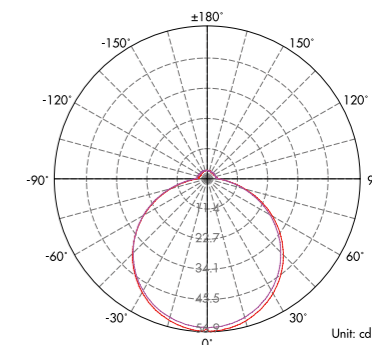
General Data	
Item No.	SP-001-0400-E
Power	4 Watts
LED type	30 pcs 2835 SMD LED
Luminous flux	100~120 lm when it's in normal status 50~60 lm when it's emergency time
CCT	2700K, 3000K, 4000K, 6000K
CRI	80+
Beam angle	120°
Dimension	105x81x40 mm (Length x Wide x Height)
Cut out	98x65x54.5 mm
Net weight	0.369 kgs
Warranty	1 year
Certifications	CE, RoHS
Electrical Data	
Input voltage	AC 220-240V or AC110~120V
Insulation class	Class I
Cable	1 x cable 0.3 M H05RN-F 3x0.75mm square to open wires
Driver	Built-in high voltage constant current driver with transformer
Battery	With built-in lithium battery for emergency illumination with 90 minutes at min.
Construction Data	
IP rating	IP65 Waterproof
IK rating	IK06
Housing	Solid Passivated (Anodizing) Aluminum CNC machined
Protection finishing	20~25µm thickness anodized film for housing. Dark grey
Trim	Tempered glass painted in milky white
Glass	Tempered Glass, T=4mm.
Loading capacity	320 kgs
Cable Gland	PG7 IP67
Gasket	Flat PMQ silicone seal
Accessories	
Mounting Sleeve	Aluminium
Packaging	
Inner box size	130*105*80 mm
Carton size	54x28.5x34 cm (32 PCS items each carton)



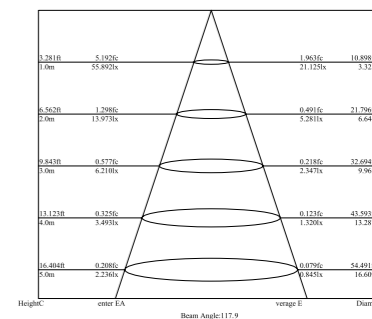
Dimension



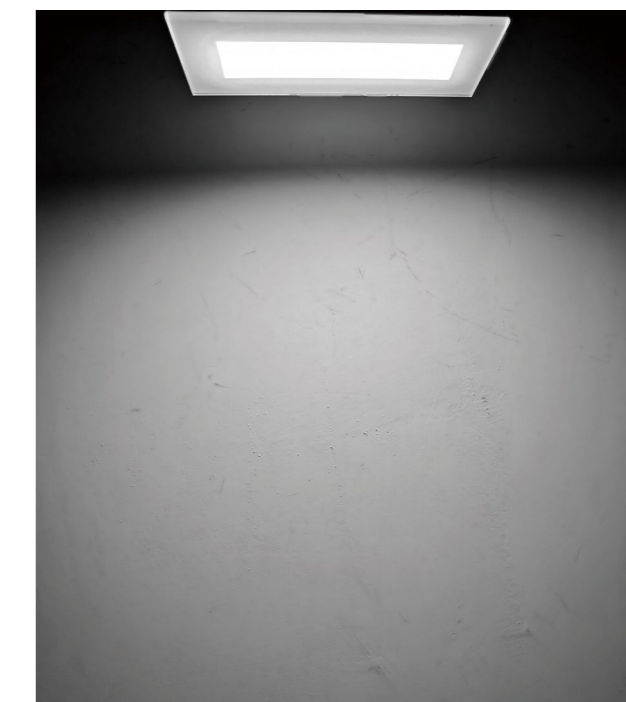
Light Distribution Curve (3000K, 120°)



Lux distance Curve (3000K, 120°)



Illumination Picture (120°)



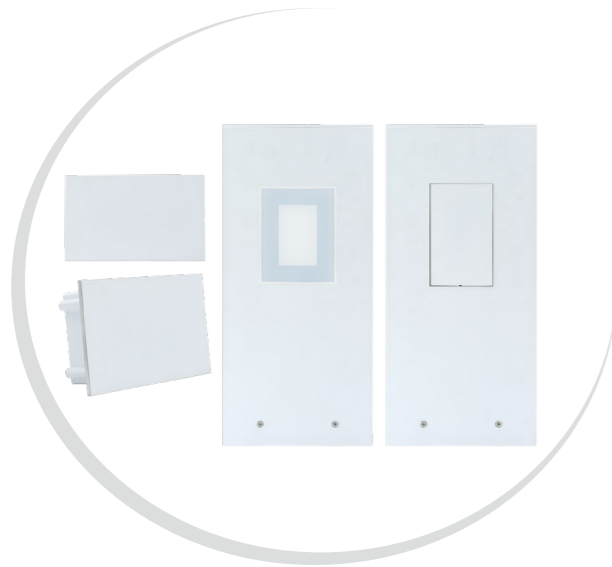
CE RoHS COMPLIANT IP65 IK06

Passivated 1 Years Warranty

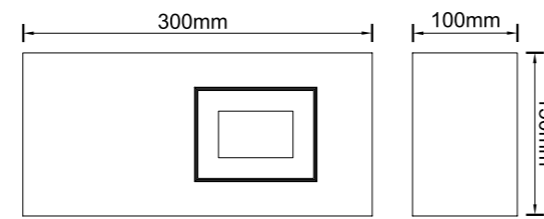
With battery for emergency illumination!
1 PC SP-001-0400-E = 1 PC General Step Light + 1 PC Emergency Light!

Parameter

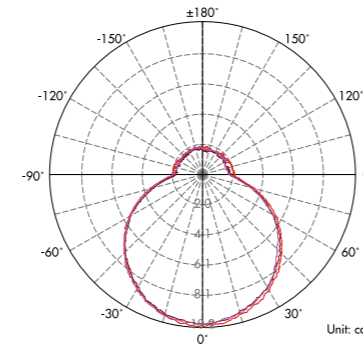
General Data	
Item No.	SP-005-0800-E
Power	8 Watts
LED type	42 pcs 2835 SMD LED
Luminous flux	200~240 lm when it's in normal status 100~120 lm when it's emergency time
CCT	2700K, 3000K, 4000K, 6000K
CRI	80+
Beam angle	120°
Dimension	182x81x43 mm (Length x Wide x Height)
Cut out	173 x 65 x 54.5 mm
Net weight	0.373 kgs
Warranty	1 year
Certifications	CE, RoHS
Electrical Data	
Input voltage	AC 220-240V or AC110~120V
Insulation class	Class I
Cable	1 x cable 0.3 M H05RN-F 3x0.75mm square to open wires
Driver	Built-in high voltage constant current driver with transformer
Battery	With built-in lithium battery for emergency illumination with 90 minutes at min.
Construction Data	
IP rating	IP65 Waterproof
IK rating	IK06
Housing	Solid Passivated (Anodizing) Aluminum CNC machined
Protection finishing	20~25µm thickness anodized film for housing. Dark grey
Trim	Tempered glass painted in milky white
Glass	Tempered Glass, T=4mm.
Loading capacity	320 kgs
Cable Gland	PG7 IP67
Gasket	Flat PMQ silicone seal
Accessories	
Mounting Sleeve	Aluminium
Packaging	
Inner box size	208*105*70 mm
Carton size	42x22x46 cm (24 PCS items each carton)



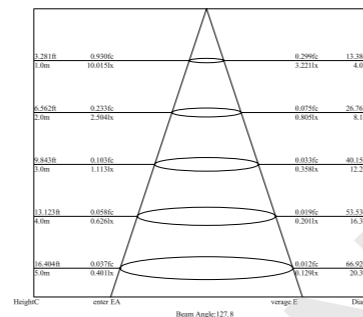
Dimension



Light Distribution Curve (3000K, 120°)



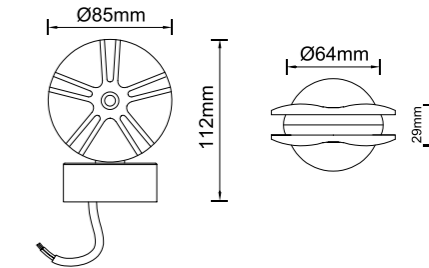
Lux distance Curve (3000K, 120°)



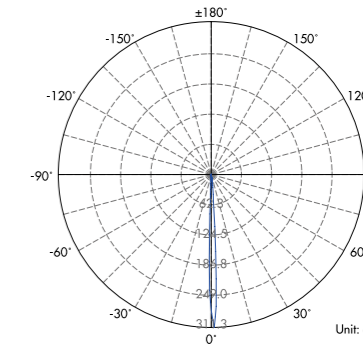
Illumination Picture (120°)



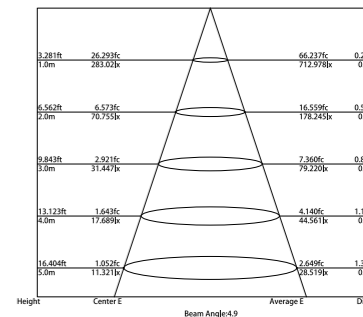
Dimension



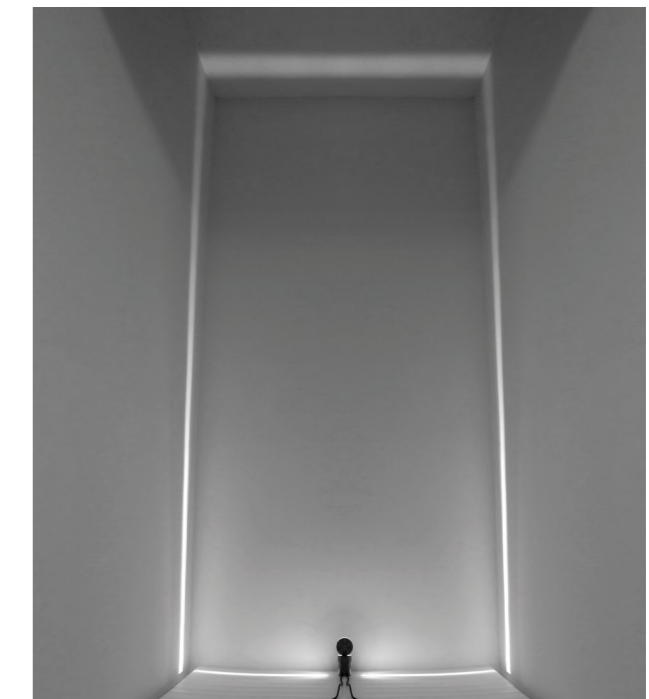
Light Distribution Curve (3000K, 300° * 5°)



Lux distance Curve (3000K, 300° * 5°)



Illumination Picture (300° * 5°)



CE RoHS COMPLIANT IP65 IK06

Passivated 1 Year Warranty

Replaceable wall lights!

Parameter

General Data	
Item No.	BL-003
Power	8 Watts
LED type	With 2 PCS replaceable SP001 in two sides
Luminous flux	200~240 lm
CCT	2700K, 3000K, 4000K, 6000K
CRI	80+
Beam angle	120° + 120°
Dimension	150x100x300 (mm) Length x Width x Height
Cut out	/
Net weight	1.89 kgs
Warranty	1 year
Certifications	CE, RoHS
Electrical Data	
Input voltage	AC100~240V
Insulation class	Class I
Cable	2 x cable 0.3 M H05RN-F 3x0.75mm square to open wires
Driver	Built-in high voltage constant current driver with transformer
Construction Data	
IP rating	IP65 Waterproof
IK rating	IK06
Housing	Aluminium coated painted in white color
Protection finishing	Aluminium coated painted in white color
Trim	Aluminium coated painted in white color
Glass	Tempered glass painted in milky white, T=4mm
Loading capacity	320 kgs
Cable Gland	PG7 IP67
Gasket	Flat PMQ silicone seal
Accessories	
Cover	Aluminium cover available for sealing one side that's without wall lights.
Packaging	
Inner box size	310*150*100 mm
Carton size	33*32*22 cm (4PCS/Carton)

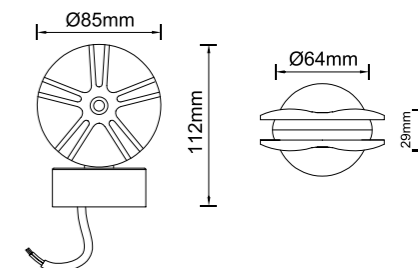
CE RoHS COMPLIANT IP66 IK06

Passivated 1 Year Warranty

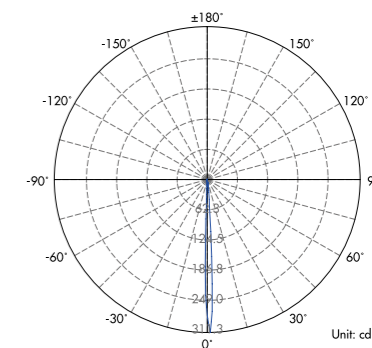
Parameter

General Data	
Item No.	UL-3001-0500-CH
Power	5 Watts
LED type	4PCS CREE XPE LED
Luminous flux	110~130 lm
CCT	2700K, 3000K, 4000K, 6000K
CRI	80+
Beam angle	300° * 5°
Dimension	Ø85 x 112 (mm) Diameter x length
Cut out	/
Net weight	0.44kgs
Warranty	1 year
Certifications	CE, RoHS
Electrical Data	
Input voltage	AC100~265V as standard, or DC24V as optional
Insulation class	Class I
Cable	1PC rubber cable 1M H05RN-F 3x1mm square
Driver	Built-in high voltage constant current driver with transformer
Construction Data	
IP rating	IP66 Waterproof
IK rating	IK06
Housing	Solid Passivated (Anodizing) Aluminum CNC machined
Protection finishing	20~25µm thickness anodized film for housing. Dark grey
Trim	Solid Passivated (Anodizing) Aluminum CNC machined
Glass	/
Loading capacity	320 kgs
Cable Gland	PG7
Gasket	Silicone O-ring
Accessories	
base	Aluminum round base with screws for surface mounting
Packaging	
Inner box size	90*70*150 mm
Carton size	37.5*20.5*32.5 cm (20 PCS / carton)

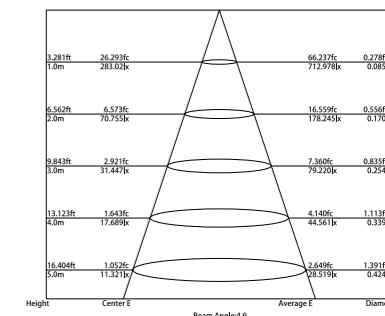
Dimension



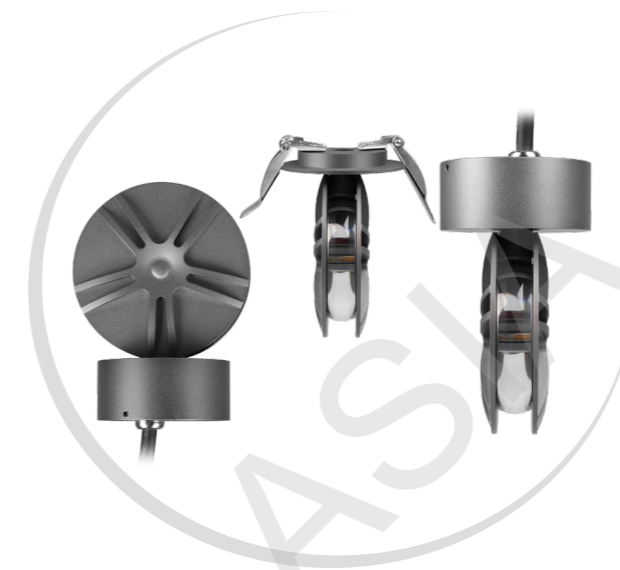
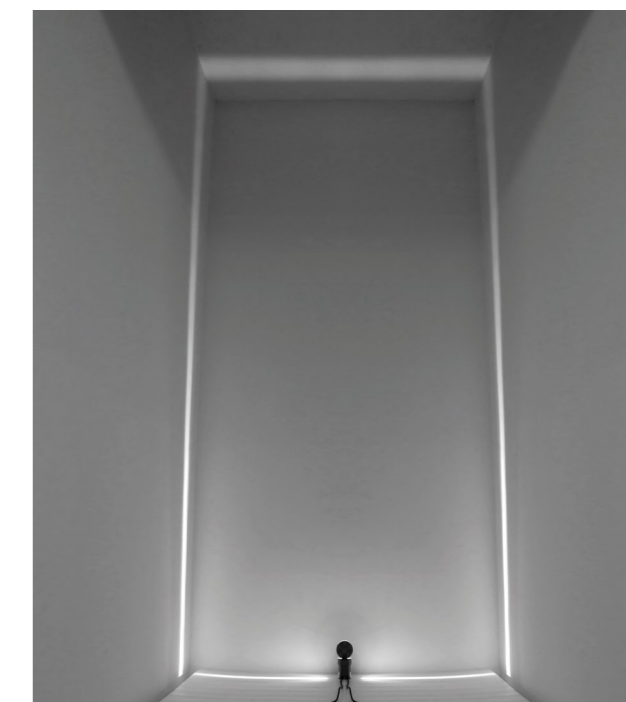
Light Distribution Curve (3000K, 300° * 5°)



Lux distance Curve (3000K, 300° * 5°)



Illumination Picture (300° * 5°)



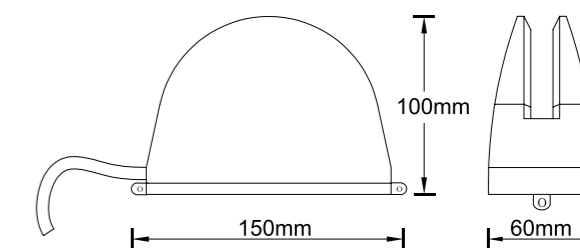
CE RoHS COMPLIANT IP66 IK07

Passivated 1 Year Warranty

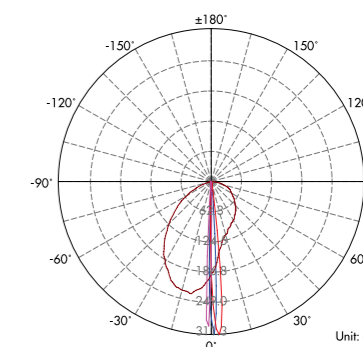
Parameter

General Data	
Item No.	UL-3001-0500RGBW/C
Power	5 Watts
LED type	4PCS 4 in 1 RGBW LED
Luminous flux	110~130 lm
CCT	RGB+WW/NW/CW
CRI	80+
Beam angle	300° * 5°
Dimension	Ø85 x 112 (mm) Diameter x length
Cut out	/
Net weight	0.44kgs
Warranty	1 year
Certifications	CE, RoHS
Electrical Data	
Input voltage	DC24V
Insulation class	Class III
Cable	1PC rubber cable 1.5M H05RN-F 5x0.75mm square for RGBW
Driver	Low voltage constant current output, excluding the transformer
Construction Data	
IP rating	IP66 Waterproof
IK rating	IK07
Housing	Solid Passivated (Anodizing) Aluminum CNC machined
Protection finishing	20~25µm thickness anodized film for housing. Dark grey
Trim	Solid Passivated (Anodizing) Aluminum CNC machined
Glass	/
Loading capacity	320 kgs
Cable Gland	PG7
Gasket	Silicone O-ring
Accessories	
base	Aluminum round base with screws for surface mounting
Packaging	
Inner box size	90*70*150 mm
Carton size	37.5*20.5*32.5 cm (20 PCS / carton)

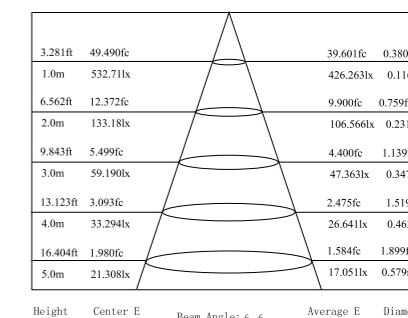
Dimension



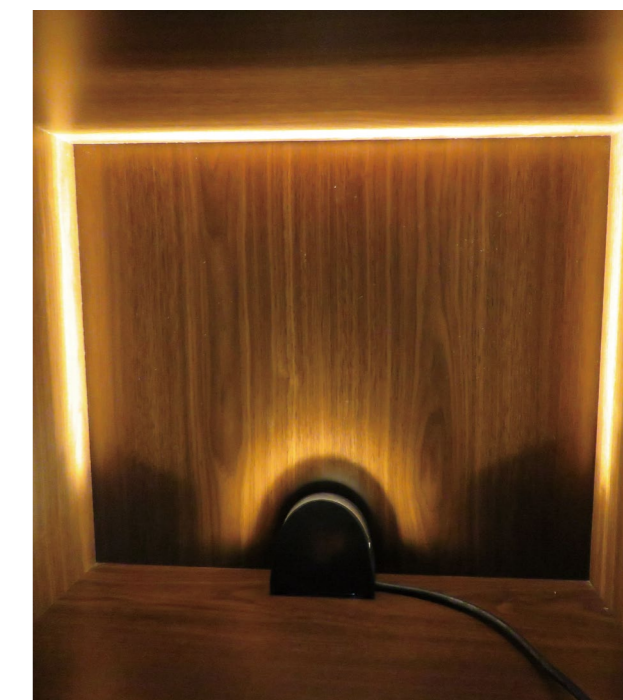
Light Distribution Curve (3000K, 150° * 5°)



Lux distance Curve (3000K, 150° * 5°)



Illumination Picture (150° * 5°)



CE RoHS COMPLIANT IP65 IK10

1 Year Warranty

Parameter

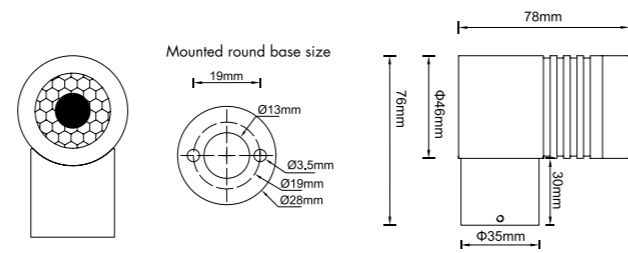
General Data	
Item No.	AC100-265V:UL-3001-0700EH DC24V: UL-3001-0700E
Power	7 Watts +10%
LED type	3PCS CREE XPE LED
Luminous flux	280 lm +10%
CCT	2700K, 3000K, 4000K, 6000K
CRI	80+
Beam angle	150° * 5°
Dimension	150*60*100 (mm) Length x Width x Height
Cut out	/ mm
Net weight	0.58 kgs
Warranty	1 year
Certifications	CE, RoHS
Electrical Data	
Input voltage	AC100-265V or DC24V
Insulation class	Class I or Class III
Cable	1PC rubber cable 1m H05RN-F 3 or 2x 1mm square
Driver	AC100-265V:builtin constant current driver DC24V:constant low voltage input,constant current output for LEDs
Construction Data	
IP rating	IP65 Waterproof
IK rating	IK10
Housing	Aluminum
Protection finishing	Powder coated painting in white or dark grey as options
Trim	Aluminium
Glass	/
Loading capacity	/
Cable Gland	PG gland
Gasket	silicone ring + silicone glue seal
Accessories	
base	Aluminum base with screws for surface mounting
Packaging	
Inner box size	/ mm
Carton size	/ cm (/ PCS / carton)



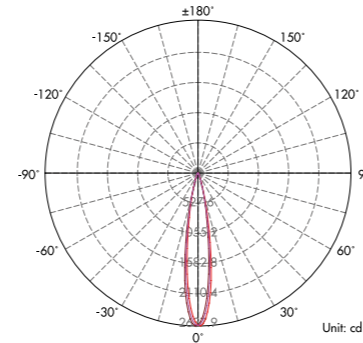
Playwall S3



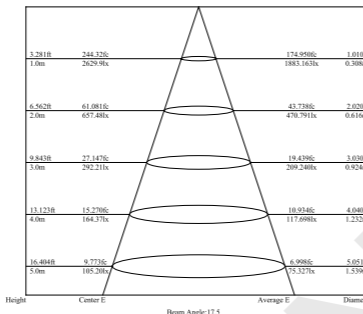
Dimension



Light Distribution Curve (3000K, 15°)



Lux distance Curve (3000K, 15°)



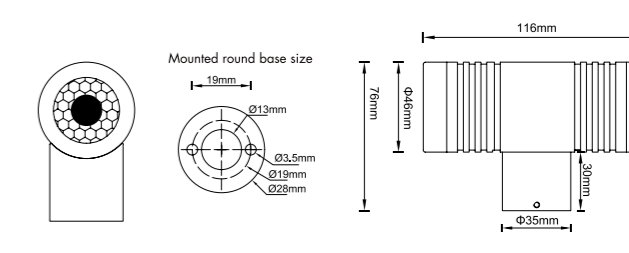
Illumination Picture (15°)



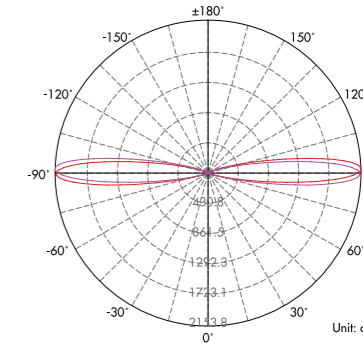
Playwall S7



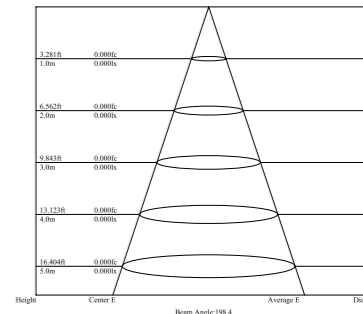
Dimension



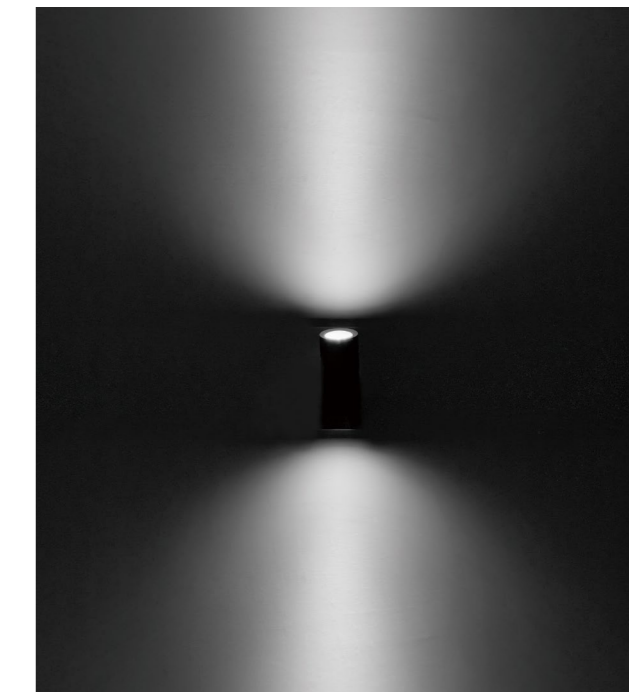
Light Distribution Curve (3000K, 2x15°)



Lux distance Curve (3000K, 2x15°)



Illumination Picture (2x15°)



CE RoHS COMPLIANT IP65 IK04

1 Year Warranty

Parameter

General Data	
Item No.	DC12-24V: WL-3001-0300B / AC100-265V: WL-3001-0300-BH
Power	DC24V: 3.5W ± 10% / AC100-265V: 3.5W ± 10%
LED type	1 PC 3.5W CREE CXA1304 COB LED
Luminous flux	DC24V: 350lm ± 10% / AC100-265V: 310lm ± 10%
CCT	2700K, 3000K, 4000K, 5700K, 6500K
CRI	80+
Beam angle	15°, 24°, 36°, 60°
Dimension	78*76*Ø46 (mm) (Length x Width x Diameter)
Cut out	/ mm
Net weight	0.32 kgs
Warranty	1 year
Certifications	CE, RoHS
Electrical Data	
Input voltage	DC24V or AC100-265V
Insulation class	Class III or I
Cable	1PC rubber cable 20 cm H05RN-F 2 or 3 x0.5mm square
Driver	DC24V: constant low voltage input, constant current output driver for LED AC100-265V: built-in constant current driver
Construction Data	
IP rating	IP65 Waterproof
IK rating	IK04
Housing	Solid Passivated (Anodizing) Aluminum CNC machined
Protection finishing	anodizing + powder coated painting in dark grey
Trim	Aluminum
Glass	Tempered glass T=2mm
Loading capacity	220 kgs
Cable Gland	PG gland
Gasket	silicone ring + silicone glue seal
Accessories	
Round base	Wall mounted base with screws
Packaging	
Inner box size	95*85*60mm
Carton size	45*40.5*14.5CM (40PCS/CTN)

CE RoHS COMPLIANT IP65 IK04

1 Year Warranty

Parameter

General Data	
Item No.	DC12-24V: WL-6001-0700B / AC100-265V: WL-6001-0700-BH
Power	DC24V: 7W ± 10% / AC100-265V: 7.5W ± 10%
LED type	2 PCS 3.5W CREE CXA1304 COB LED
Luminous flux	DC24V: 800lm ± 10% / AC100-265V: 800lm ± 10%
CCT	2700K, 3000K, 4000K, 5700K, 6500K
CRI	80+
Beam angle	15°, 24°, 36°, 60°
Dimension	116*76*Ø46 (mm) (Length x Width x Diameter)
Cut out	/ mm
Net weight	0.45 kgs
Warranty	1 year
Certifications	CE, RoHS
Electrical Data	
Input voltage	DC24V or AC100-265V
Insulation class	Class III or I
Cable	1PC rubber cable 20 cm H05RN-F 2 or 3 x0.5mm square
Driver	DC24V: constant low voltage input, constant current output driver for LED AC100-265V: built-in constant current driver
Construction Data	
IP rating	IP65 Waterproof
IK rating	IK04
Housing	Solid Passivated (Anodizing) Aluminum CNC machined
Protection finishing	anodizing + powder coated painting in dark grey
Trim	Aluminum
Glass	Tempered glass T=2mm
Loading capacity	220 kgs
Cable Gland	PG gland
Gasket	silicone ring + silicone glue seal
Accessories	
Round base	Wall mounted base with screws
Packaging	
Inner box size	125*85*60mm
Carton size	45*27*14.5CM (20PCS/CTN)

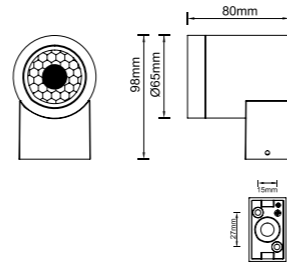
Playwall S9



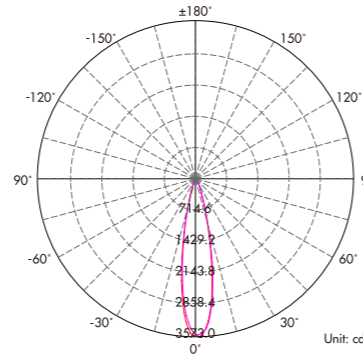
CE RoHS COMPLIANT IP65 IK04
1 Year Warranty

Parameter	
General Data	
Item No.	WL9W-COB-0900-AH
Power	9W+10%
LED type	1 PC 9W CREE CXA1507 COB LED
Luminous flux	750lm +10%
CCT	2700K,3000K,4000K,5700K,6500K
CRI	80+
Beam angle	10°, 23°, 36°
Dimension	80*98*Ø65 (mm) (Length x Width x Diameter)
Cut out	/ mm
Net weight	0.5 kgs
Warranty	1 year
Certifications	CE, RoHS
Electrical Data	
Input voltage	AC100-265V
Insulation class	Class I
Cable	1PC rubber cable 20 cm H05RN-F 3 x 1 mm square
Driver	builtin constant current driver
Construction Data	
IP rating	IP65 Waterproof
IK rating	IK04
Housing	Aluminum
Protection finishing	Powder coated painting Aluminum in white or dark grey or black colour
Trim	Aluminum
Glass	Tempered glass T=2mm
Loading capacity	/
Cable Gland	PG gland
Gasket	silicone ring + silicone glue seal
Accessories	
Round base	Wall mounted base with screws
Packaging	
Inner box size	90*70*105mm
Carton size	38*37*13 cm (20 PCS / carton)

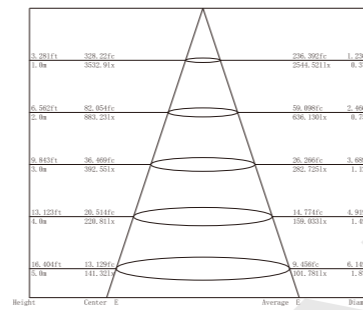
Dimension



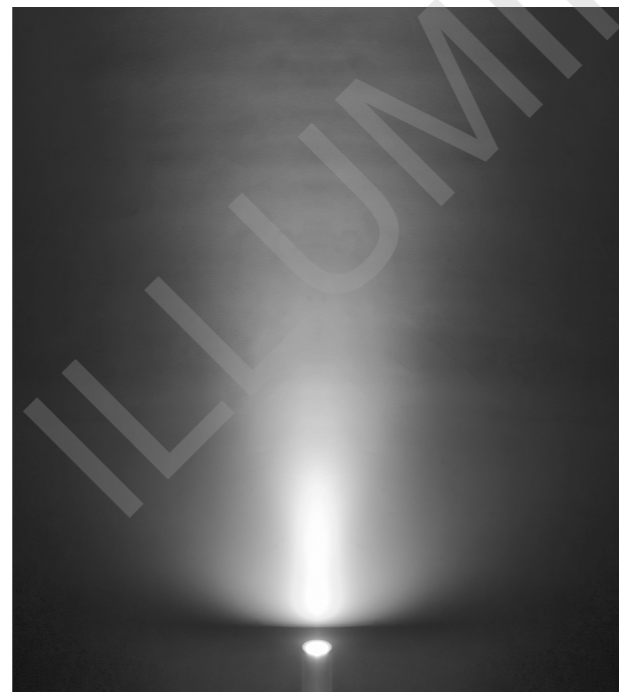
Light Distribution Curve (3000K, 23°)



Lux distance Curve (3000K, 23°)



Illumination Picture (23°)



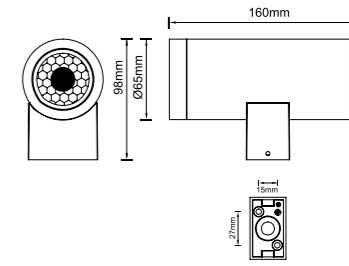
Playwall S18



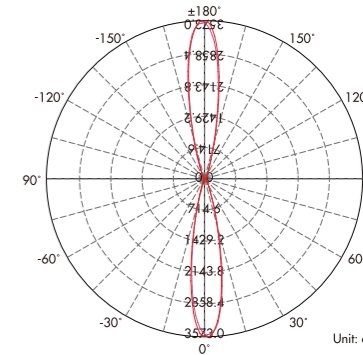
CE RoHS COMPLIANT IP65 IK04
1 Year Warranty

Parameter	
General Data	
Item No.	WL18W-COB-1800-AH
Power	18W+10%
LED type	2 PCS 9W CREE CXA1507 COB LED
Luminous flux	1500lm +10%
CCT	2700K,3000K,4000K,5700K,6500K
CRI	80+
Beam angle	10°, 23°, 36°
Dimension	160*98*Ø65 (mm) (Length x Width x Diameter)
Cut out	/ mm
Net weight	0.8 kgs
Warranty	1 year
Certifications	CE, RoHS
Electrical Data	
Input voltage	AC100-265V
Insulation class	Class I
Cable	1PC rubber cable 20 cm H05RN-F 3 x 1 mm square
Driver	builtin constant current driver
Construction Data	
IP rating	IP65 Waterproof
IK rating	IK04
Housing	Aluminum
Protection finishing	Powder coated painting Aluminum in white or dark grey or black colour
Trim	Aluminum
Glass	Tempered glass T=2mm
Loading capacity	/
Cable Gland	PG gland
Gasket	silicone ring + silicone glue seal
Accessories	
Round base	Wall mounted base with screws
Packaging	
Inner box size	180*90*70 mm
Carton size	38.5*38*16.5 cm (18 PCS / carton)

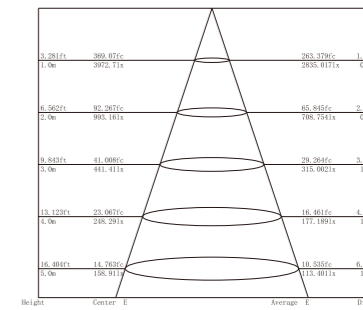
Dimension



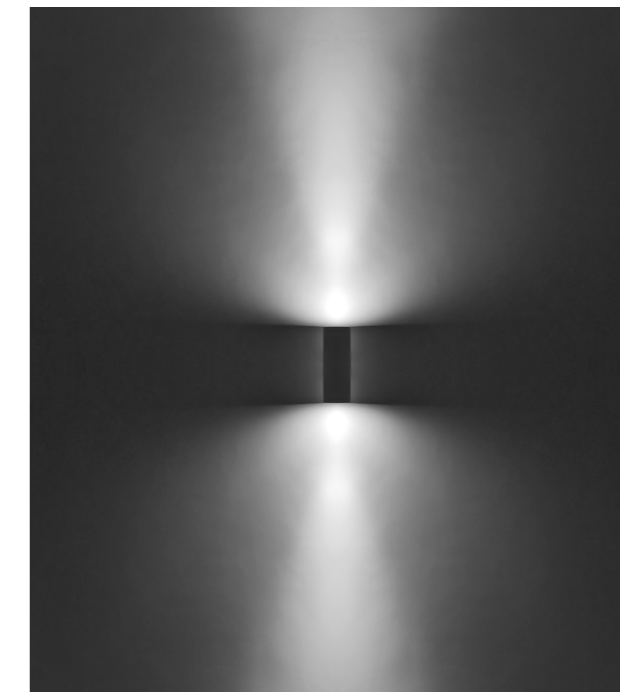
Light Distribution Curve (3000K, 2x23°)

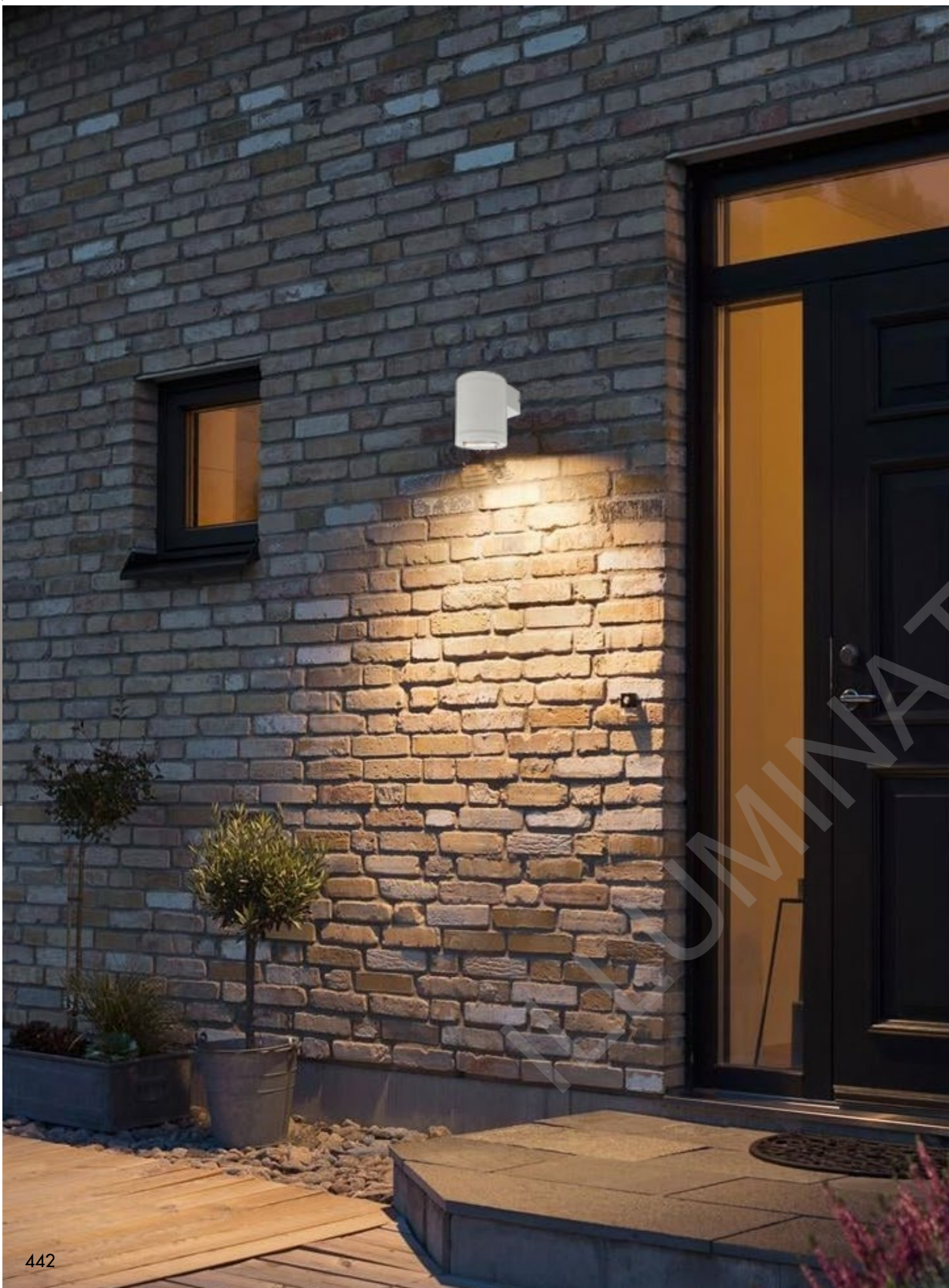


Lux distance Curve (3000K, 2x23°)



Illumination Picture (2x23°)





Playwall 360

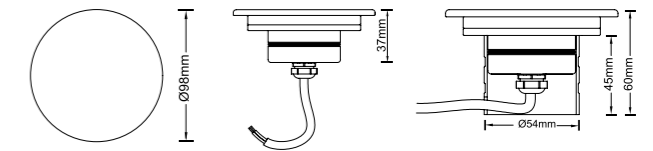


CE RoHS COMPLIANT IP67 IK10
1 Year Warranty

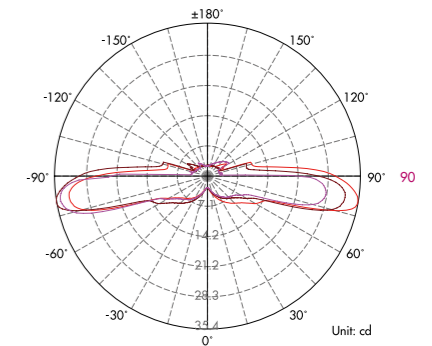
Parameter

General Data	
Item No.	DC24V: UL-E001-0400-A (98mm) / AC100-265V: UL-E001-0400-AH (98mm)
Power	4W ± 10%
LED type	18 PCS OSRAM 2835 SMD LED
Luminous flux	140lm ± 10%
CCT	2700K, 3000K, 4000K, 6000K
CRI	80+
Beam angle	360°
Dimension	Ø98x37 (mm) Diameter x Height
Cut out	Ø54mm
Net weight	0.5 kgs
Warranty	1 year
Certifications CE, RoHS	
Electrical Data	
Input voltage	DC24V (AC100-265V optional)
Insulation class	Class III (Class I)
Cable	TPC rubber cable 1M H05RN-F 2 or 3 x 1 mm square
Driver	Low constant voltage input, constant current output driver for LED or builtin high voltage constant current driver
Construction Data	
IP rating	IP67 Waterproof
IK rating	IK10
Housing	Solid Passivated (Anodizing) Aluminum CNC machined
Protection finishing	20~25µm thickness anodized film for housing. Dark grey
Trim	Aluminium anodizing + powder coated painting in dark grey or black or white
Glass	Without glass, but with PMMA diffuser
Loading capacity	100 kgs
Cable Gland	PG gland
Gasket	O-ring PMQ silicone seal
Accessories	
Mounting Sleeve	Passivated (Anodizing) Aluminum CNC machined. Dark grey
Packaging	
Inner box size	105*105*85 mm
Carton size	55*23.5*19.5 cm (20PCS/ carton)

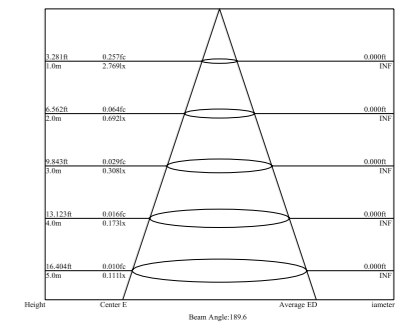
Dimension



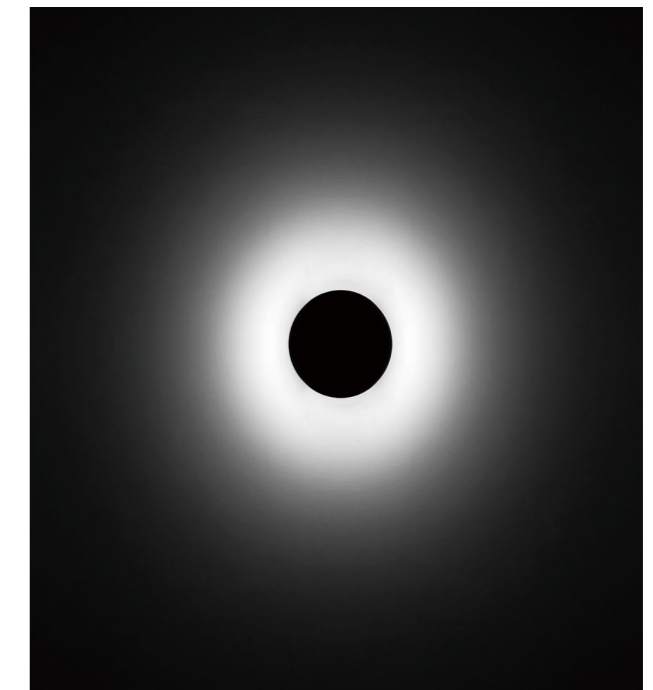
Light Distribution Curve (3000K,360°)



Lux distance Curve(3000K,360°)



Illumination Picture (360°)







Specialized in Exterior LED Lighting

LED PROJECTOR LIGHTING SERIES

Products Features

These products are designed with die-casting aluminium, with powder coated painting anti-corrosion finishing for housing in black color, optics PMMA lens with wonderful light output, tempered glass for high loading capacity, silicone gasket and cable gland for waterproof IP65 and high quality OSRAM LED, good quality built-in constant current driver.

These products are with CE, RoHS certifications, and the SAA, PSE, UL or ETL certifications will be available in the coming future.

Application

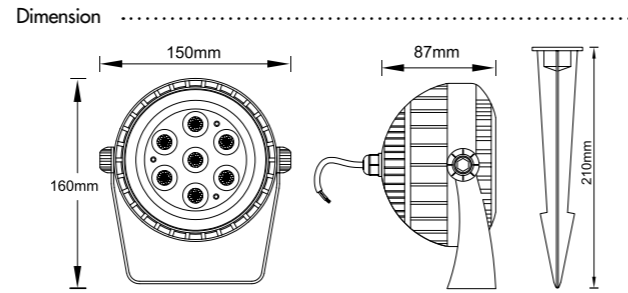
These lights are widely used in the exterior application, such as lighting columns, walls, trees, architectural features, landscape features for the hotel, the garden, the park, the building etc.

1 Year Warranty

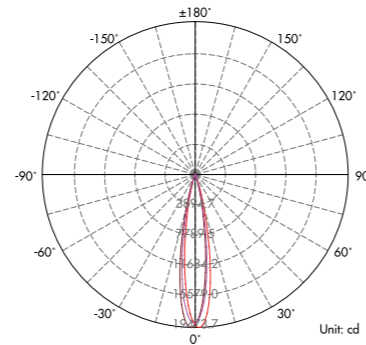


IP65 IK04

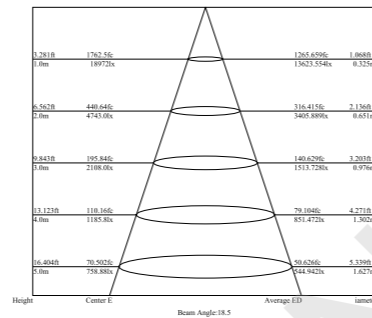




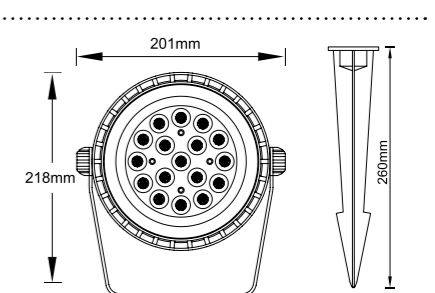
Light Distribution Curve (3000K, 30°)



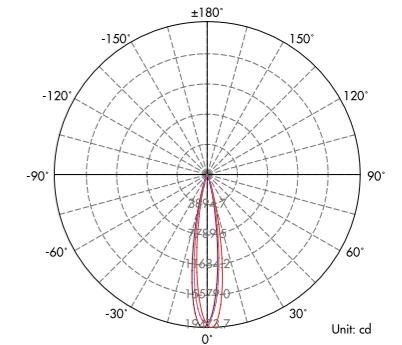
Lux distance Curve (3000K, 30°)



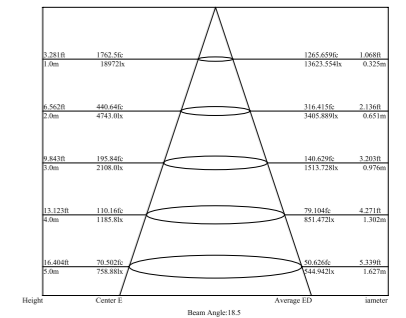
Illumination Picture (30°)



Light Distribution Curve (3000K, 30°)



Lux distance Curve (3000K, 30°)



Illumination Picture (30°)



CE RoHS COMPLIANT IP65 IK04

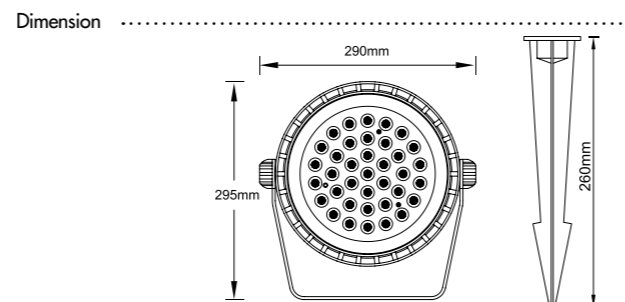
1 Year Warranty

Parameter	
General Data	
Item No.	FL7001-0700-AH / FL7001-1400-AH
Power	7 Watts as standard (14 watts optional)
LED type	7 PCS 1W LUMINUS LED or 7 PCS 2W OSRAM LED
Luminous flux	600lm~650lm
CCT	2700K, 3000K, 4000K, 6000K
CRI	80+
Beam angle	10°, 25°, 30°, 45°, 60°, 85°
Dimension	150 x 160 x 87 (mm) Diameter x Height x Thickness
Cut out	/
Net weight	1.21 kgs
Warranty	1 year
Certifications	CE, RoHS
Electrical Data	
Input voltage	AC 90V-265V
Insulation class	Class I
Cable	1PC rubber cable 1M H05RN-F 3x1mm square
Driver	Built-in high voltage constant current driver with transformer
Construction Data	
IP rating	IP65 Waterproof
IK rating	IK04
Housing	Die-casting Aluminium
Protection finishing	Powder coated painting in black color
Trim	Die-casting Aluminium
Glass	Tempered Glass, T=4mm
Loading capacity	220 kgs
Cable Gland	PG7 IP67
Gasket	PMQ silicone gasket seal
Accessories	
Bracket	With Aluminium spike as options
Packaging	
Inner box size	160*100*175 mm
Carton size	42.5*34*20 cm (8 PCS / carton)

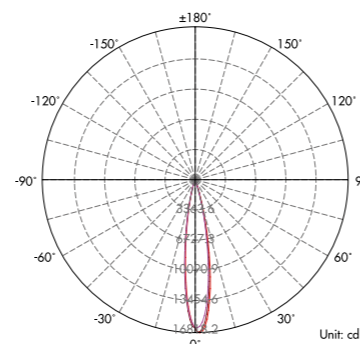
CE RoHS COMPLIANT IP65 IK04

1 Year Warranty

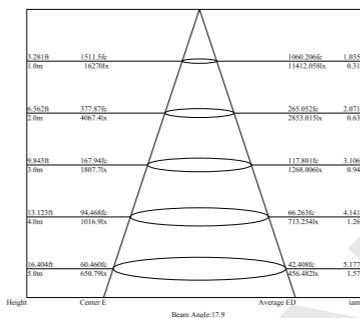
Parameter	
General Data	
Item No.	FL1701-1700-AH / FL1701-3400-AH
Power	17 Watts as standard (34 watts optional)
LED type	17 PCS 1W LUMINUS LED or 17 PCS 2W OSRAM LED
Luminous flux	1450lm~1550lm
CCT	2700K, 3000K, 4000K, 6000K
CRI	80+
Beam angle	10°, 25°, 30°, 45°, 60°, 85°
Dimension	181 x 218 x 87 (mm) Diameter x Height x Thickness
Cut out	/
Net weight	1.76 kgs
Warranty	1 year
Certifications	CE, RoHS
Electrical Data	
Input voltage	AC 90V-265V
Insulation class	Class I
Cable	1PC rubber cable 1M H05RN-F 3x1mm square
Driver	Built-in high voltage constant current driver with transformer
Construction Data	
IP rating	IP65 Waterproof
IK rating	IK04
Housing	Die-casting Aluminium
Protection finishing	Powder coated painting in black color
Trim	Die-casting Aluminium
Glass	Tempered Glass, T=4mm
Loading capacity	220 kgs
Cable Gland	PG7 IP67
Gasket	PMQ silicone seal
Accessories	
Bracket	With Aluminium spike as options
Packaging	
Inner box size	250*220*120 mm
Carton size	52*44*26.5 cm (8 PCS / carton)



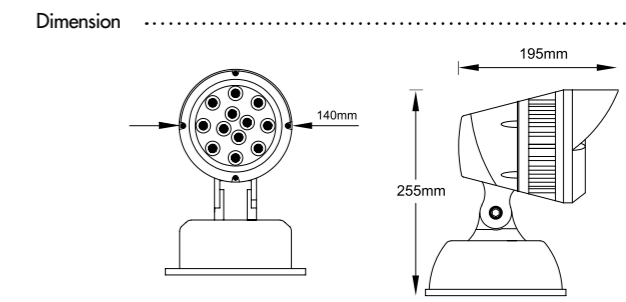
Light Distribution Curve (3000K, 30°)



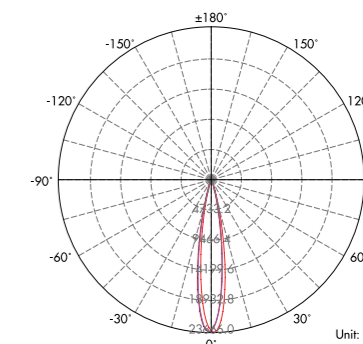
Lux distance Curve (3000K, 30°)



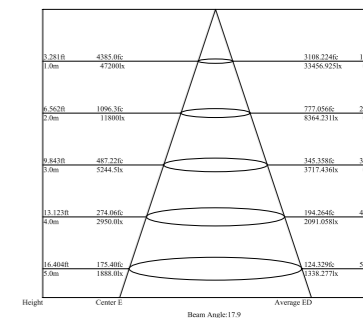
Illumination Picture (30°)



Light Distribution Curve (3000K, 30°)



Lux distance Curve (3000K, 30°)



Illumination Picture (30°)

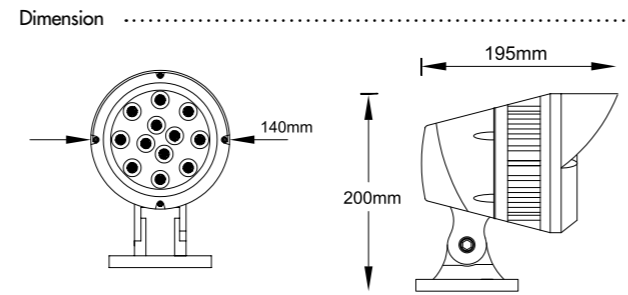


CE RoHS COMPLIANT IP65 IK04
1 Year Warranty

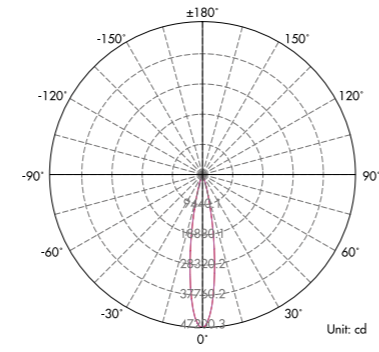
Parameter	
General Data	
Item No.	FL-3601-3600-AH / FL-3601-3600-RGBA / FL-3601-5000-AH
Power	36 Watts / 36 Watts / 50 Watts
LED type	36 PCS 1W LUMINUS LED or RGB 12PCS Red LED, 12 PCS Green LED, 12PCS Blue LED OSRAM LED or 36PCS 2W OSRAM LED
Luminous flux	2950lm~3100 lm
CCT	2700K, 3000K, 4000K, 6000K
CRI	80+
Beam angle	10°, 25°, 30°, 45°, 60°, 85°
Dimension	250 x 295 x 87 (mm) Diameter x Height x Thickness
Cut out	/
Net weight	4.7 kgs
Warranty	1 year
Certifications	CE, RoHS
Electrical Data	
Input voltage	AC 90V-265V
Insulation class	Class I
Cable	1PC rubber cable 1.5M H05RN-F 3 or 4 x 0.75mm square
Driver	Built-in high voltage constant current driver with transformer
Construction Data	
IP rating	IP65 Waterproof
IK rating	IK04
Housing	Die-casting Aluminium
Protection finishing	Powder coated painting in black color
Trim	Die-casting Aluminium
Glass	Tempered Glass, T=4mm
Loading capacity	220 kgs
Cable Gland	PG7 IP67
Gasket	PMQ silicone gasket seal
Accessories	
Bracket	With Aluminium spike as options
Packaging	
Inner box size	320*300*160 mm
Carton size	62*32*18.5 cm (4 PCS / carton)

CE RoHS COMPLIANT IP65 IK04
1 Year Warranty

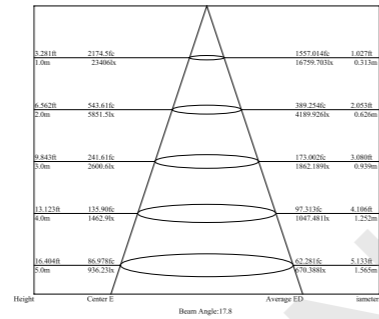
Parameter	
General Data	
Item No.	FL-1201-1200-AH / FL-1201-2400-AH
Power	12 Watts as standard (24 watt as optional)
LED type	12 PCS 1W OSRAM LED
Luminous flux	1000~1100 lm
CCT	2700K, 3000K, 4000K, 6000K
CRI	80+
Beam angle	10°, 25°, 30°, 45°, 60°, 85°
Dimension	140 x 255 (mm) Diameter x Height
Cut out	/
Net weight	1.86 kgs
Warranty	1 year
Certifications	CE, RoHS
Electrical Data	
Input voltage	AC 90V-265V
Insulation class	Class I
Cable	1PC PVC cable 1M H05RN-F 3x1mm square
Driver	Built-in high voltage constant current driver with transformer
Construction Data	
IP rating	IP65 Waterproof
IK rating	IK04
Housing	Die-casting Aluminium
Protection finishing	Powder coated painting in black color
Trim	Die-casting Aluminium
Glass	Tempered Glass, T=4mm
Loading capacity	220 kgs
Cable Gland	PG7 IP67
Gasket	PMQ silicone gasket seal
Accessories	
Round Base	With round base that's for mounting on the ground and for wires connecting inside the base
Shield	With shield that's for anti-glare
Packaging	
Inner box size	220*220*280 mm
Carton size	46*46*30.5 cm (8PCS / carton)



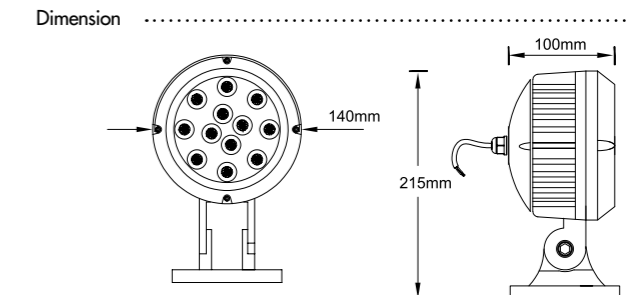
Light Distribution Curve (3000K, 30°)



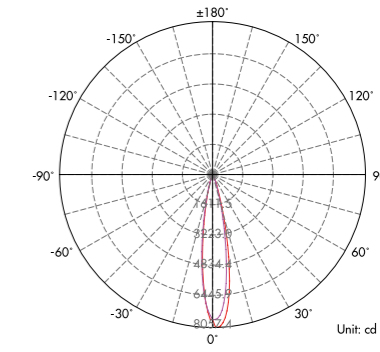
Lux distance Curve (3000K, 30°)



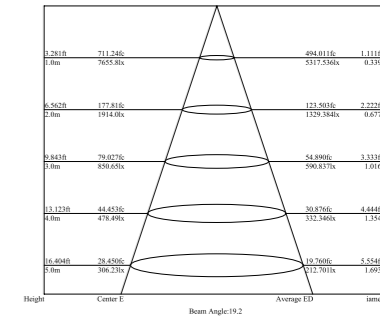
Illumination Picture (30°)



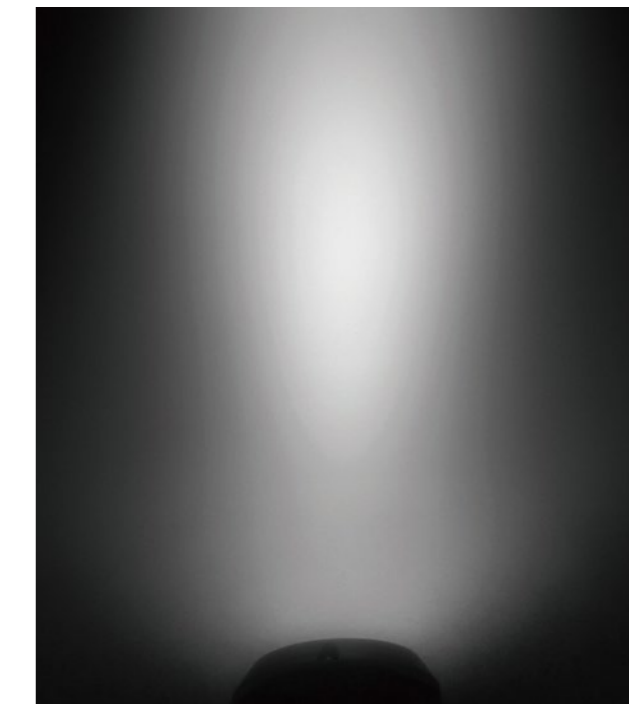
Light Distribution Curve (3000K, 30°)



Lux distance Curve (3000K, 30°)



Illumination Picture (30°)



CE RoHS COMPLIANT IP65 IK04
1 Year Warranty

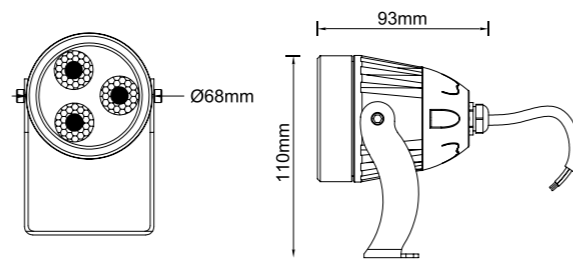
Parameter	
General Data	
Item No.	FL-1201-1200-BH / FL-1201-2400-BH
Power	12 Watts as standard [24 watt as optional]
LED type	12 PCS 1W OSRAM LED
Luminous flux	1000~1100 lm
CCT	2700K, 3000K, 4000K, 6000K
CRI	80+
Beam angle	10°, 25°, 30°, 45°, 60°, 85°
Dimension	140 x 200 (mm) Diameter x Height
Cut out	/
Net weight	1.55 kgs
Warranty	1 year
Certifications	CE, RoHS
Electrical Data	
Input voltage	AC 90V-265V
Insulation class	Class I
Cable	1PC PVC cable 1M H05RN-F 3x1mm square
Driver	Built-in high voltage constant current driver with transformer
Construction Data	
IP rating	IP65 Waterproof
IK rating	IK04
Housing	Die-casting Aluminium
Protection finishing	Powder coated painting in black color
Trim	Die-casting Aluminium
Glass	Tempered Glass, T=4mm
Loading capacity	220 kgs
Cable Gland	PG7 IP67
Gasket	PMQ silicone gasket seal
Accessories	
Round Base	With round base that's for mounting on the ground
Shield	With shield that's for anti-glare
Packaging	
Inner box size	220*160*220 mm
Carton size	66.5*46*24.5 cm (8PCS / carton)

CE RoHS COMPLIANT IP65 IK04
1 Year Warranty

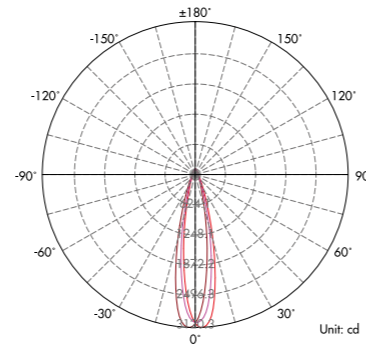
Parameter	
General Data	
Item No.	FL-1201-1200-CH / FL-1201-2400-CH
Power	12 Watts as standard [24 watt as optional]
LED type	12 PCS 1W OSRAM LED
Luminous flux	1000~1100 lm
CCT	2700K, 3000K, 4000K, 6000K
CRI	80+
Beam angle	10°, 25°, 30°, 45°, 60°, 85°
Dimension	140 x 215 (mm) Diameter x Height
Cut out	/
Net weight	1.45 kgs
Warranty	1 year
Certifications	CE, RoHS
Electrical Data	
Input voltage	AC 90V-265V
Insulation class	Class I
Cable	1PC PVC cable 1M H05RN-F 3x1mm square
Driver	Built-in high voltage constant current driver with transformer
Construction Data	
IP rating	IP65 Waterproof
IK rating	IK04
Housing	Die-casting Aluminium
Protection finishing	Powder coated painting in black color
Trim	Die-casting Aluminium
Glass	Tempered Glass, T=4mm
Loading capacity	220 kgs
Cable Gland	PG7 IP67
Gasket	PMQ silicone gasket seal
Accessories	
Round Base	With round base that's for mounting on the ground
Packaging	
Inner box size	150*150*230 mm
Carton size	48*32*25.5 cm (8PCS / carton)



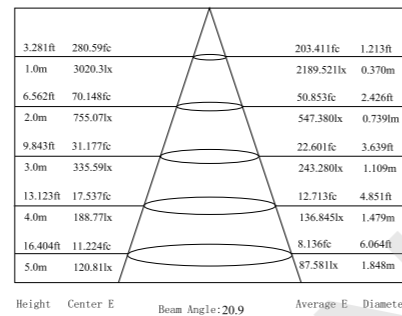
Dimension



Light Distribution Curve (3000K, 23°)



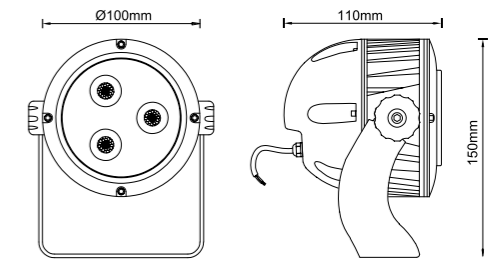
Lux distance Curve (3000K, 23°)



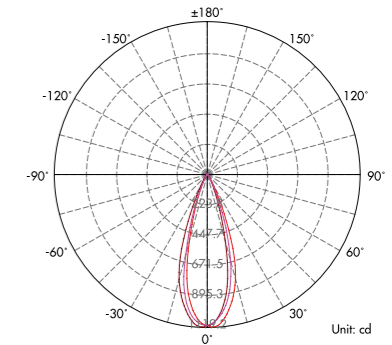
Illumination Picture (23°)



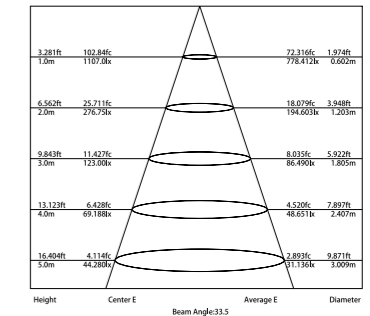
Dimension



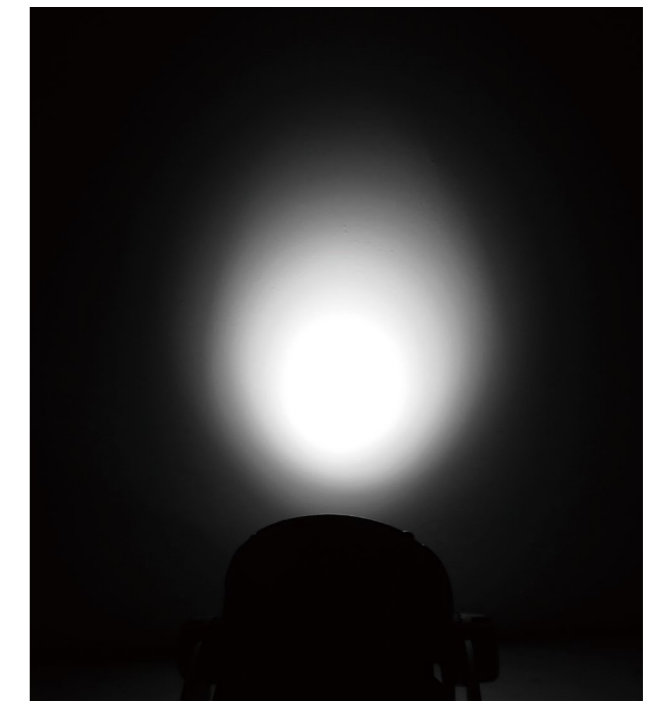
Light Distribution Curve (3000K, 28°)



Lux distance Curve (3000K, 28°)



Illumination Picture (28°)



CE RoHS COMPLIANT IP65 IK04
1 Year Warranty

Parameter

General Data	
Item No.	FL-3001-0900-A
Power	9 watts (3W,6W as options)
LED type	3 PCS 3W OSRAM LED
Luminous flux	650~700 lm
CCT	2700K, 3000K, 4000K, 6000K
CRI	80+
Beam angle	6°, 8°, 10°, 17°, 23°, 28°, 43°
Dimension	Ø68*93 (mm) Diameter x Height
Cut out	/
Net weight	0.41 kgs
Warranty	1 year
Certifications	CE, RoHS
Electrical Data	
Input voltage	DC 12V or DC 24V
Insulation class	Class III
Cable	1PC rubber cable 0.3M H05RN-F 2x1 mm square
Driver	Low voltage constant current driver without transformer
Construction Data	
IP rating	IP65 Waterproof
IK rating	IK04
Housing	Die-casting Aluminium
Protection finishing	Powder coated painted in grey
Trim	Die-casting Aluminium
Glass	Step tempered Glass, T=3mm.
Loading capacity	220 kgs
Cable Gland	PG7 IP67
Gasket	O-ring PMQ silicone seal
Accessories	
Spike	The spike is optional
Packaging	
Inner box size	
Carton size	53*27*28 cm (30 PCS / carton)

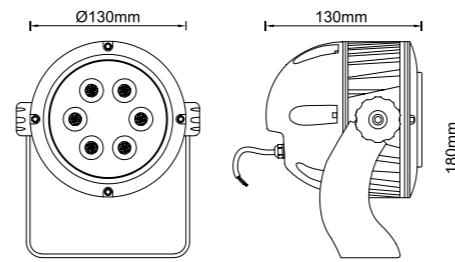
CE RoHS COMPLIANT IP65 IK04
1 Year Warranty

Parameter

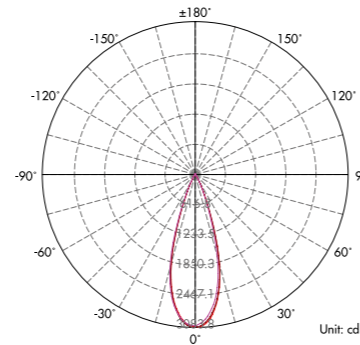
General Data	
Item No.	TGD-100150-9D
Power	9 watts
LED type	10 PCS OSRAM 3030 LED
Luminous flux	90~100lm/W
CCT	2700K, 3000K, 4000K, 6000K
CRI	80+
Beam angle	15°, 25°, 30°, 45°, 60°
Dimension	Ø100*110 (mm) Diameter x Height
Cut out	/
Net weight	1 kgs
Warranty	1 year
Certifications	CE, RoHS
Electrical Data	
Input voltage	AC100~265V
Insulation class	Class I
Cable	1PC rubber cable 0.3M H05RN-F 3*1.5mm² mm square
Driver	Built-in high voltage constant current driver with transformer
Construction Data	
IP rating	IP65 Waterproof
IK rating	IK04
Housing	Die-casting Aluminium
Protection finishing	Powder coated painted in grey
Trim	Die-casting Aluminium
Glass	Step tempered Glass, T=4mm.
Loading capacity	220 kgs
Cable Gland	PG7 IP67
Gasket	O-ring PMQ silicone seal
Accessories	
Spike	The spike is optional
Packaging	
Inner box size	160 x130 x130 mm
Carton size	34*28*28 cm (8 PCS / carton)



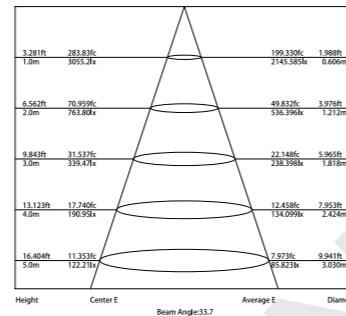
Dimension



Light Distribution Curve (3000K, 28°)



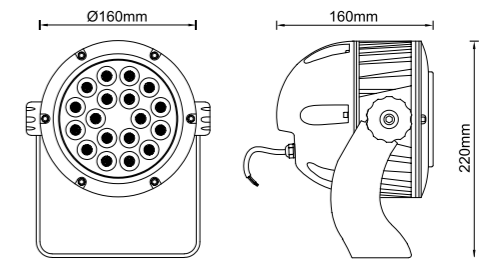
Lux distance Curve (3000K, 28°)



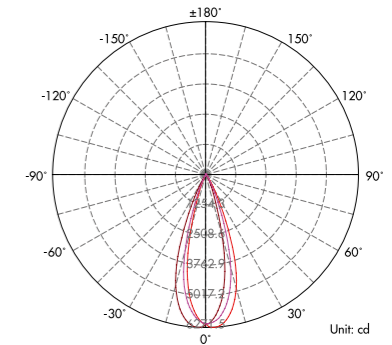
Illumination Picture (28°)



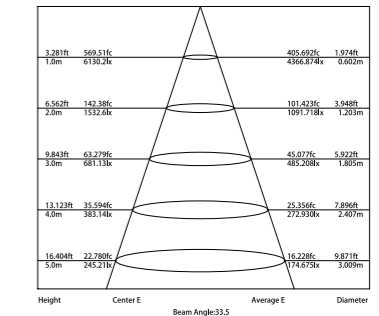
Dimension



Light Distribution Curve (3000K, 28°)



Lux distance Curve (3000K, 28°)



Illumination Picture (28°)



CE RoHS COMPLIANT IP65 IK04

1 Year Warranty

Parameter

General Data	
Item No.	TGD-130130-24D
Power	24 watts
LED type	24 PCS OSRAM 3030 LED
Luminous flux	90-100lm/W
CCT	2700K, 3000K, 4000K, 6000K
CRI	80+
Beam angle	15°, 25°, 30°, 45°, 60°
Dimension	Ø130*130 (mm) Diameter x Height
Cut out	/
Net weight	1.7 kgs
Warranty	1 year
Certifications	CE, RoHS
Electrical Data	
Input voltage	AC100~265V
Insulation class	Class I
Cable	1PC rubber cable 0.3M H05RN-F 3*1.5mm ² mm square
Driver	Built-in high voltage constant current driver with transformer
Construction Data	
IP rating	IP65 Waterproof
IK rating	IK04
Housing	Die-casting Aluminium
Protection finishing	Powder coated painted in grey
Trim	Die-casting Aluminium
Glass	Step tempered Glass, T=4mm.
Loading capacity	220 kgs
Cable Gland	PG7 IP67
Gasket	O-ring PMQ silicone seal
Accessories	
Spike	The spike is optional
Packaging	
Inner box size	240x170x150 mm
Carton size	40*36*17 cm (4 PCS / carton)

CE RoHS COMPLIANT IP65 IK04

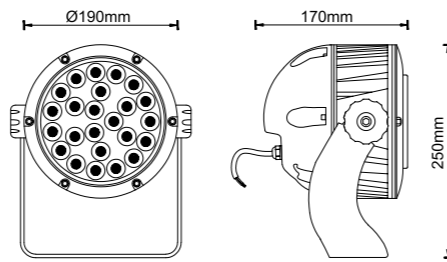
1 Year Warranty

Parameter

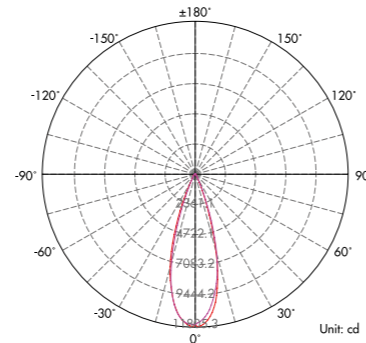
General Data	
Item No.	TGD-160160-36D
Power	36 watts
LED type	36 PCS OSRAM 3030 LED
Luminous flux	90-100lm/W
CCT	2700K, 3000K, 4000K, 6000K
CRI	80+
Beam angle	15°, 25°, 30°, 45°, 60°
Dimension	Ø160*160 (mm) Diameter x Height
Cut out	/
Net weight	2.8 kgs
Warranty	1 year
Certifications	CE, RoHS
Electrical Data	
Input voltage	AC100~265V
Insulation class	Class I
Cable	1PC rubber cable 0.3M H05RN-F 3*1.5mm ² mm square
Driver	Built-in high voltage constant current driver with transformer
Construction Data	
IP rating	IP65 Waterproof
IK rating	IK04
Housing	Die-casting Aluminium
Protection finishing	Powder coated painted in grey
Trim	Die-casting Aluminium
Glass	Step tempered Glass, T=4mm.
Loading capacity	220 kgs
Cable Gland	PG7 IP67
Gasket	O-ring PMQ silicone seal
Accessories	
Spike	The spike is optional
Packaging	
Inner box size	240x210x180 mm
Carton size	50*44.5*20.5 cm (4 PCS / carton)



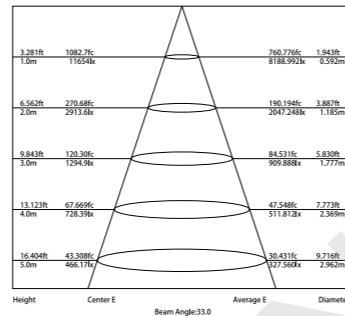
Dimension



Light Distribution Curve (3000K, 28°)



Lux distance Curve (3000K, 28°)



Illumination Picture (28°)

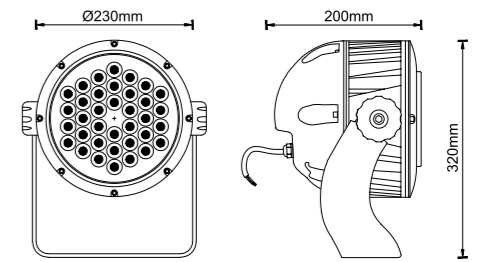


CE RoHS COMPLIANT IP65 IK04
1 Year Warranty

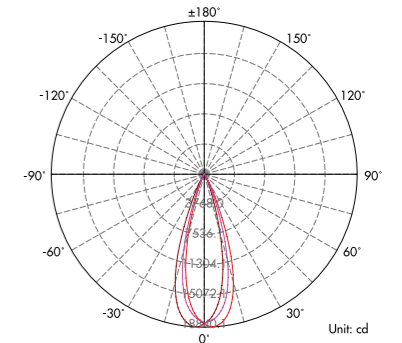
Parameter	
General Data	
Item No.	TGD-190170-48D
Power	48 watts
LED type	48 PCS OSRAM 3030 LED
Luminous flux	90-100lm/W
CCT	2700K, 3000K, 4000K, 6000K
CRI	80+
Beam angle	15°, 25°, 30°, 45°, 60°
Dimension	Ø190*170 (mm) Diameter x Height
Cut out	/
Net weight	3.2 kgs
Warranty	1 year
Certifications	CE, RoHS
Electrical Data	
Input voltage	AC100~265V
Insulation class	Class I
Cable	1PC rubber cable 0.3M H05RN-F 3*1.5mm ² mm square
Driver	Built-in high voltage constant current driver with transformer
Construction Data	
IP rating	IP65 Waterproof
IK rating	IK04
Housing	Die-casting Aluminium
Protection finishing	Powder coated painted in grey
Trim	Die-casting Aluminium
Glass	Step tempered Glass, T=4mm.
Loading capacity	220 kgs
Cable Gland	PG7 IP67
Gasket	O-ring PMQ silicone seal
Accessories	
Spike	The spike is optional
Packaging	
Inner box size	240x270x200 mm
Carton size	51*29*22 cm (2 PCS / carton)



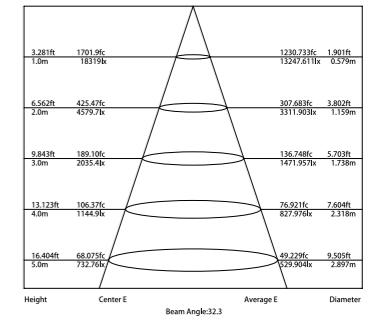
Dimension



Light Distribution Curve (3000K, 28°)



Lux distance Curve (3000K, 28°)



Illumination Picture (28°)

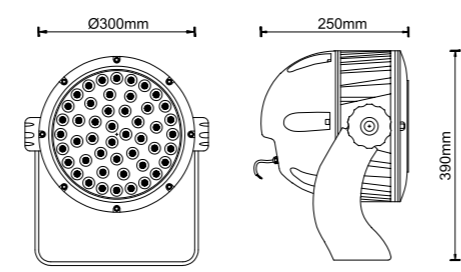


CE RoHS COMPLIANT IP65 IK04
1 Year Warranty

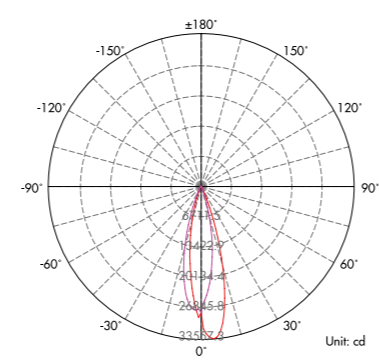
Parameter	
General Data	
Item No.	TGD-230200-72D
Power	72 watts
LED type	72 PCS OSRAM 3030 LED
Luminous flux	90-100lm/W
CCT	2700K, 3000K, 4000K, 6000K
CRI	80+
Beam angle	15°, 25°, 30°, 45°, 60°
Dimension	Ø230*200 (mm) Diameter x Height
Cut out	/
Net weight	6 kgs
Warranty	1 year
Certifications	CE, RoHS
Electrical Data	
Input voltage	AC100~265V
Insulation class	Class I
Cable	1PC rubber cable 0.3M H05RN-F 3*1.5mm ² mm square
Driver	Built-in high voltage constant current driver with transformer
Construction Data	
IP rating	IP65 Waterproof
IK rating	IK04
Housing	Die-casting Aluminium
Protection finishing	Powder coated painted in grey
Trim	Die-casting Aluminium
Glass	Step tempered Glass, T=4mm.
Loading capacity	220 kgs
Cable Gland	PG7 IP67
Gasket	O-ring PMQ silicone seal
Accessories	
Spike	The spike is optional
Packaging	
Inner box size	330x280x220 mm
Carton size	33*28*22 cm (1 PCS / carton)



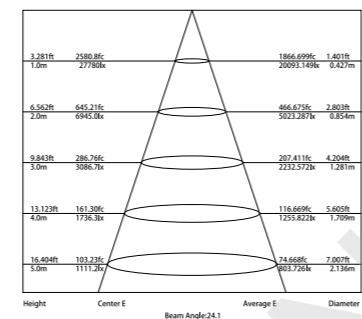
Dimension



Light Distribution Curve (3000K, 23°)



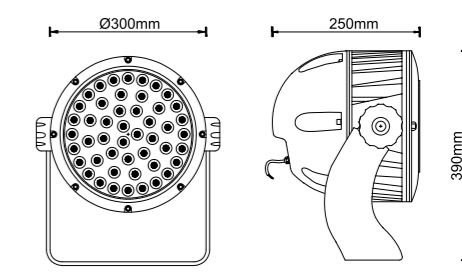
Lux distance Curve (3000K, 23°)



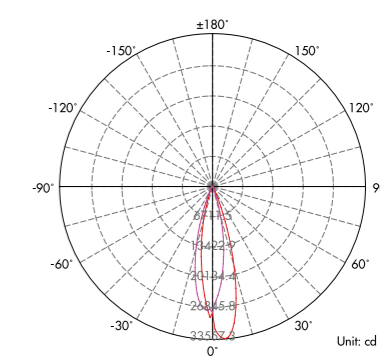
Illumination Picture (23°)



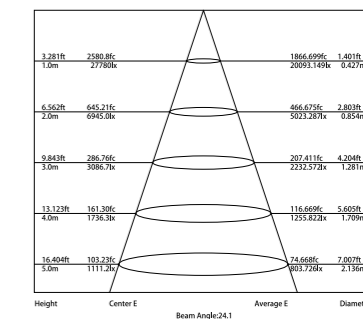
Dimension



Light Distribution Curve (3000K, 23°)



Lux distance Curve (3000K, 23°)



Illumination Picture (23°)



LED PROJECTOR LIGHTING SERIES

LED PROJECTOR LIGHTING SERIES

CE RoHS COMPLIANT IP65 IK04
1 Year Warranty

Parameter	
General Data	
Item No.	TGD-300250-100D
Power	100 watts
LED type	100 PCS OSRAM 3030 LED
Luminous flux	90-100lm/W
CCT	2700K, 3000K, 4000K, 6000K
CRI	80+
Beam angle	15°, 25°, 30°, 45°, 60°
Dimension	Ø300*250 (mm) Diameter x Height
Cut out	/
Net weight	9.8 kgs
Warranty	1 year
Certifications	CE, RoHS
Electrical Data	
Input voltage	AC100~265V
Insulation class	Class I
Cable	1PC rubber cable 0.3M H05RN-F 3*1.5mm ² mm square
Driver	Built-in high voltage constant current driver with transformer
Construction Data	
IP rating	IP65 Waterproof
IK rating	IK04
Housing	Die-casting Aluminium
Protection finishing	Powder coated painted in grey
Trim	Die-casting Aluminium
Glass	Step tempered Glass, T=4mm.
Loading capacity	220 kgs
Cable Gland	PG7 IP67
Gasket	O-ring PMQ silicone seal
Accessories	
Spike	The spike is optional
Packaging	
Inner box size	380x350x280 mm
Carton size	38*35*28 cm (1 PCS / carton)

CE RoHS COMPLIANT IP65 IK04
1 Year Warranty

Parameter	
General Data	
Item No.	TGD-300250-130D
Power	130 watts
LED type	130 PCS OSRAM 3030 LED
Luminous flux	90-100lm/W
CCT	2700K, 3000K, 4000K, 6000K
CRI	80+
Beam angle	15°, 25°, 30°, 45°, 60°
Dimension	Ø300*250 (mm) Diameter x Height
Cut out	/
Net weight	9.8 kgs
Warranty	1 year
Certifications	CE, RoHS
Electrical Data	
Input voltage	AC100~265V
Insulation class	Class I
Cable	1PC rubber cable 0.3M H05RN-F 3*1.5mm ² mm square
Driver	Built-in high voltage constant current driver with transformer
Construction Data	
IP rating	IP65 Waterproof
IK rating	IK04
Housing	Die-casting Aluminium
Protection finishing	Powder coated painted in grey
Trim	Die-casting Aluminium
Glass	Step tempered Glass, T=4mm.
Loading capacity	220 kgs
Cable Gland	PG7 IP67
Gasket	O-ring PMQ silicone seal
Accessories	
Spike	The spike is optional
Packaging	
Inner box size	380x350x280 mm
Carton size	38*35*28 cm (1 PCS / carton)









Specialized in Exterior LED Lighting

LED WALL WASHER SERIES

Products Features

These products are designed with stretched aluminium / solid aluminium, with Passivated (Anodizing) anti-corrosion finishing for housing in black color or grey color, optics PMMA lens with wonderful light output, tempered glass for high loading capacity, silicone gasket and cable gland for waterproof IP65 and high quality OSRAM LED.

These products are with CE, RoHS certifications, and the SAA, PSE, UL or ETL certifications will be available in the coming future.

Application

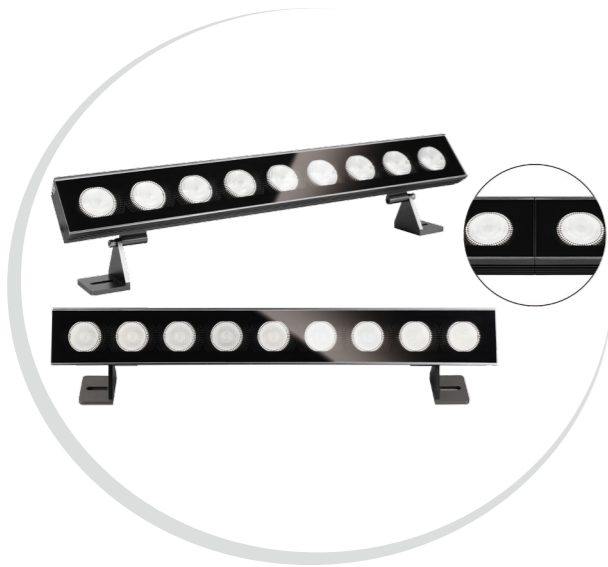
These lights are widely used in the exterior application, such as lighting walls, architectural features, landscape features for the hotel, the garden, the park, the building etc.

1 Year Warranty

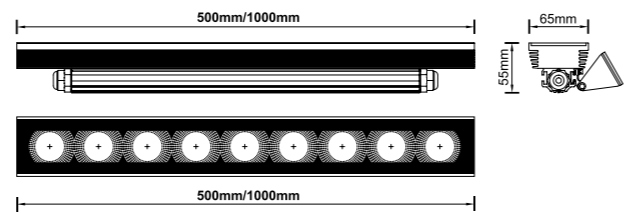


IP65 IP68 IK04

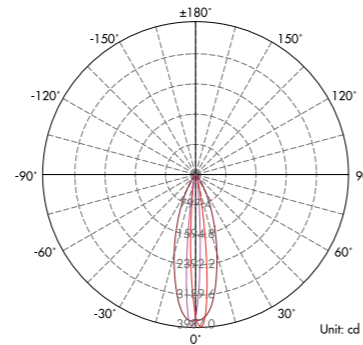




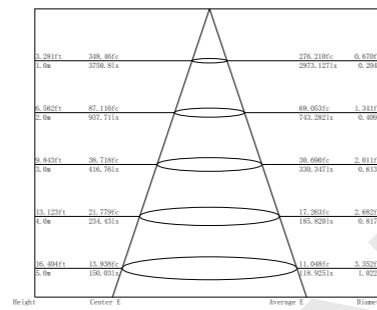
Dimension



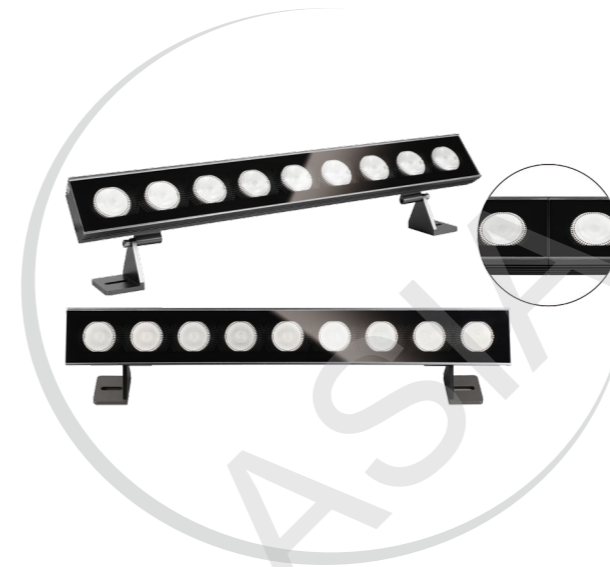
Light Distribution Curve (3000K, 10x30°)



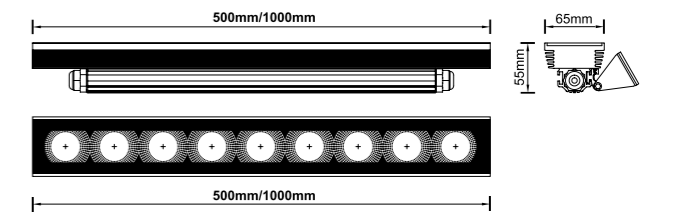
Lux distance Curve (3000K, 10x30°)



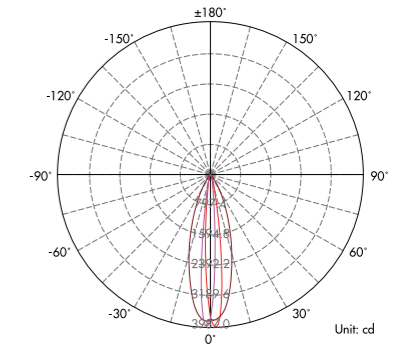
Illumination Picture (10x30°)



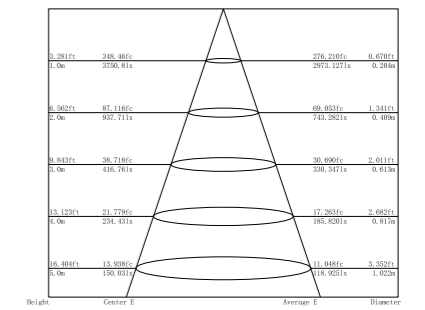
Dimension



Light Distribution Curve (RGBW, 10x30°)



Lux distance Curve (RGBW, 10x30°)



Illumination Picture (10x30°)



CE RoHS COMPLIANT IP68 IK04

1 Year Warranty

Parameter

General Data	
Item No.	LWWW-9001-4800A / LWWW-1801-9600A
Power	48 Watts / 96 Watts
LED type	9PCS / 18PCS CREE XPG LED
Luminous flux	1920lm+10% / 3840lm+10%
CCT	3000K, 4000K, 6000K
CRI	80+
Beam angle	5°, 8°, 12°, 24°, 36°, 60°, 10°*30°
Dimension	500*65*55 mm / 1000*65*55 (L x W x H)
Cut out	/
Net weight	1.92 kgs
Warranty	1 year
Certifications	CE, RoHS
Electrical Data	
Input voltage	DC12V / DC24V (AC100~240V version optional)
Insulation class	Class III
Cable	2 PCS rubber cable around 50CM 1.5mm square cables
Driver	Low voltage constant current output, excluding the transformer
Control	Stand alone
Construction Data	
IP rating	IP68 Waterproof
IK rating	IK04 for wall washer
Housing	Solid Passivated (Anodizing) Aluminum CNC machined
Protection finishing	20~25µm thickness anodized film for housing. Dark grey
Trim	Glass
Glass	Tempered Glass. T=3mm
Loading capacity	220kgs / 2000kgs
Cable Gland	PG9 IP68
Gasket	PMQ silicone gasket seal
Accessories	
Bracket	Aluminium bracket for wall washer
Packaging	
Inner box size	550*80*80 mm
Carton size	57*18*10 cm (2PCS / carton)

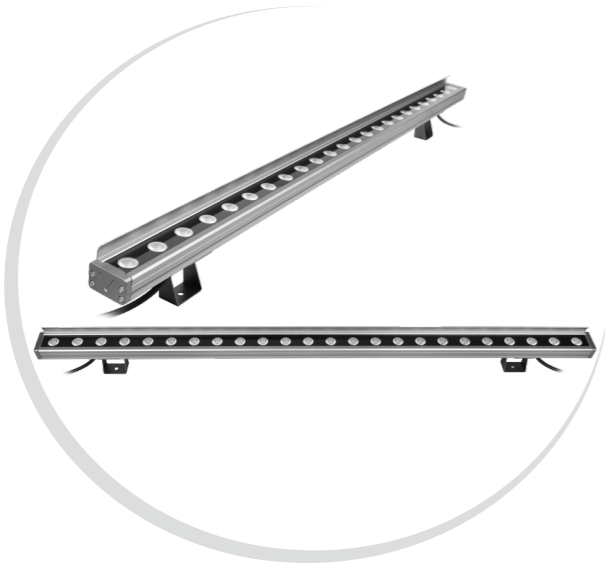
CE RoHS COMPLIANT IP68 IK04

1 Year Warranty

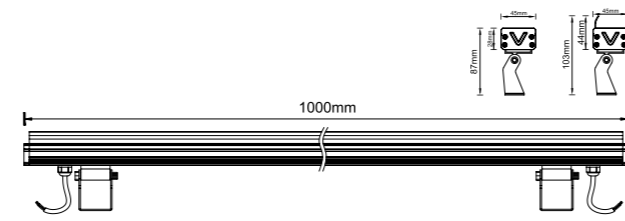
Parameter

General Data	
Item No.	LWWW-9001-RGBWA / LWWW-1801-RGBWA-A
Power	18 Watts / 36 Watts
LED type	9 PCS / 18 PCS x 4in1 RGBW 3030SMD LED
Luminous flux	720 lm / 1440lm
CCT	RGBW5500K
CRI	80+
Beam angle	5°, 8°, 12°, 24°, 36°, 60°, 10°*30°
Dimension	500*65*55 mm / 1000*65*55L x W x H
Cut out	/
Net weight	1.92 kgs
Warranty	1 year
Certifications	CE, RoHS
Electrical Data	
Input voltage	DC12V
Insulation class	Class III
Cable	2 PCS rubber cable around 50CM
Driver	Low voltage constant current output, excluding the transformer
Control	Stand alone
Construction Data	
IP rating	IP68 Waterproof
IK rating	IK04 for wall washer
Housing	Solid Passivated (Anodizing) Aluminum CNC machined
Protection finishing	20~25µm thickness anodized film for housing. Dark grey
Trim	Glass
Glass	Tempered Glass. T=3mm
Loading capacity	220kgs
Cable Gland	PG9 IP68
Gasket	PMQ silicone gasket seal
Accessories	
Bracket	Aluminium bracket for wall washer
Packaging	
Inner box size	550*80*80 mm
Carton size	57*18*10 cm (2PCS / carton)

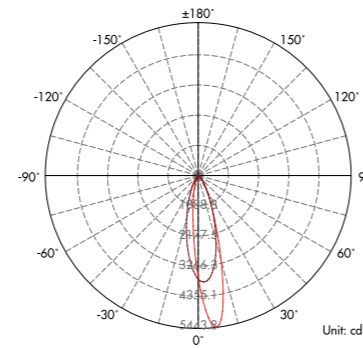




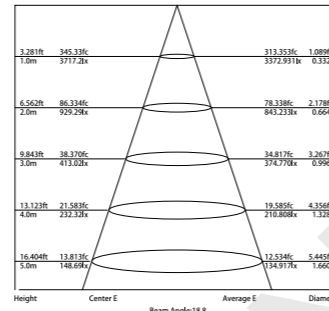
Dimension



Light Distribution Curve (3000K, 15°40°)



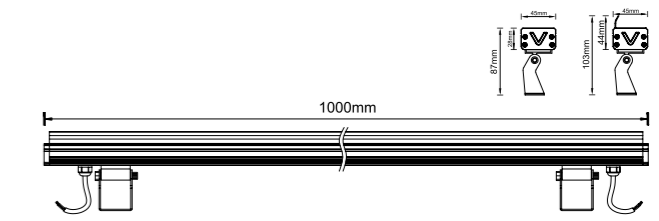
Lux distance Curve (3000K, 15°40°)



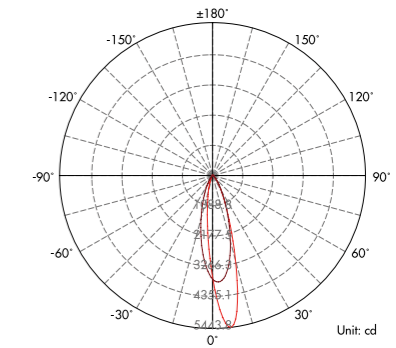
Illumination Picture (15x40°)



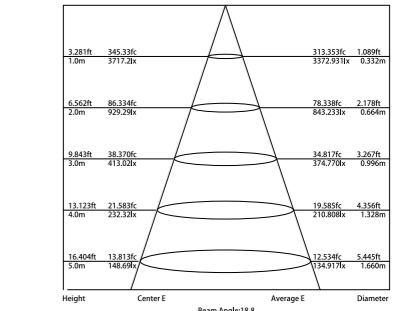
Dimension



Light Distribution Curve (3000K, 15°40°)



Lux distance Curve (3000K, 15°40°)



Illumination Picture (15x40°)



CE RoHS COMPLIANT IP65 IK04

1 Year Warranty

Parameter

General Data	
Item No.	LWWW-2401-1800-B
Power	18W
LED type	24 PCS 0.75W OSRAM LED
Luminous flux	1440lm
CCT	2700K, 3000K, 4500K, 6000K
CRI	80+
Beam angle	12°/24°/30°/40°/60° or Oval lens 15°40°
Dimension	1000*45*28 mm (Length x Width x Height)
Cut out	/
Net weight	1.7 kgs
Warranty	1 year
Certifications	CE, RoHS
Electrical Data	
Input voltage	DC24V (AC100~265V version optional)
Insulation class	Class III
Cable	2 PCS rubber cables with waterproof connectors, one side male, another side female
Driver	Low voltage constant current output, excluding the transformer
Control	Stand alone
Construction Data	
IP rating	IP65 Waterproof
IK rating	IK04
Housing	Passivated (Anodizing) Aluminium
Protection finishing	20~25µm thickness anodized film for housing. Dark grey
Trim	Aluminium+glass
Glass	Tempered Glass T=4mm
Loading capacity	220kgs
Cable Gland	PG IP65
Gasket	PMQ silicone gasket seal
Accessories	
Bracket	Aluminium bracket
Barn door	Without barn door as standard, and with barn door as options
Packaging	
Inner box size	1068*85*75mm
Carton size	108.5*28*24 cm (6PCS / carton)

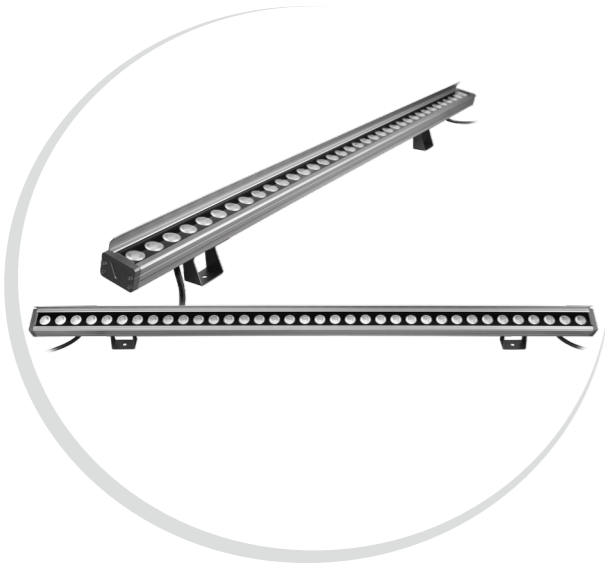
CE RoHS COMPLIANT IP65 IK04

1 Year Warranty

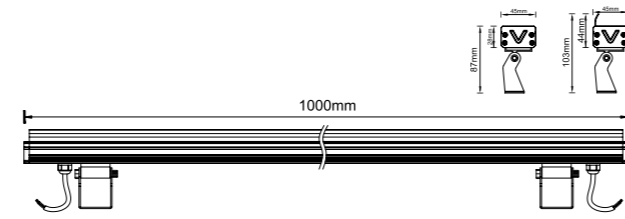
Parameter

General Data	
Item No.	LWWW-2401-2400-B
Power	24W
LED type	24 PCS 1W OSRAM LED
Luminous flux	1800lm
CCT	2700K, 3000K, 4500K, 6000K
CRI	80+
Beam angle	12°/24°/30°/40°/60° or Oval lens 15°40°
Dimension	1000*45*28 mm (Length x Width x Height)
Cut out	/
Net weight	1.7 kgs
Warranty	1 year
Certifications	CE, RoHS
Electrical Data	
Input voltage	DC24V (AC100~265V version optional)
Insulation class	Class III
Cable	2 PCS rubber cables with waterproof connectors, one side male, another side female
Driver	Low voltage constant current output, excluding the transformer
Control	Stand alone
Construction Data	
IP rating	IP65 Waterproof
IK rating	IK04
Housing	Passivated (Anodizing) Aluminium
Protection finishing	20~25µm thickness anodized film for housing. Dark grey
Trim	Aluminium+glass
Glass	Tempered Glass T=4mm
Loading capacity	220kgs
Cable Gland	PG IP65
Gasket	PMQ silicone gasket seal
Accessories	
Bracket	Aluminium bracket
Barn door	Without barn door as standard, and with barn door as options
Packaging	
Inner box size	1068*85*75mm
Carton size	108.5*28*24 cm (6PCS / carton)

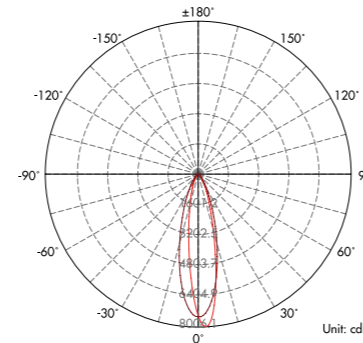




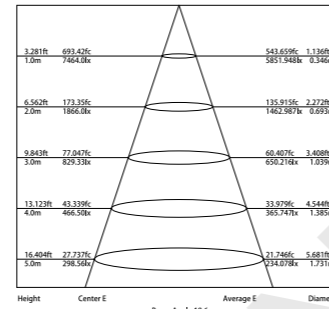
Dimension



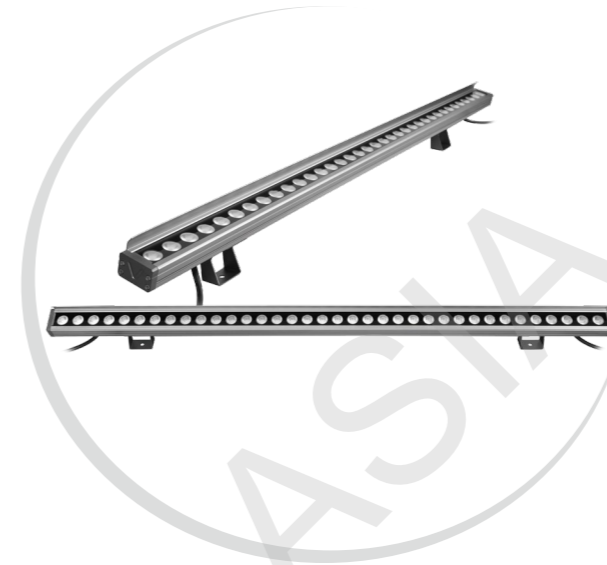
Light Distribution Curve (3000K, 15°40°)



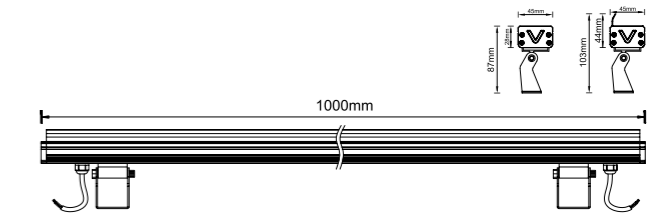
Lux distance Curve (3000K, 15°40°)



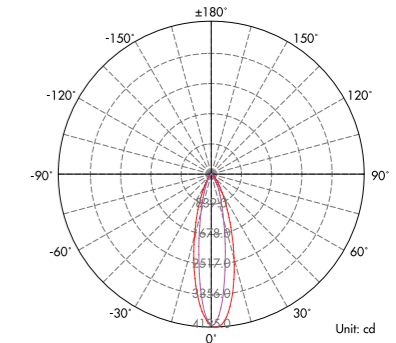
Illumination Picture (15x40°)



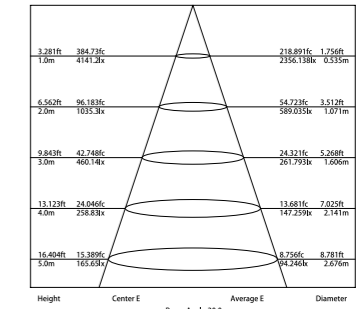
Dimension



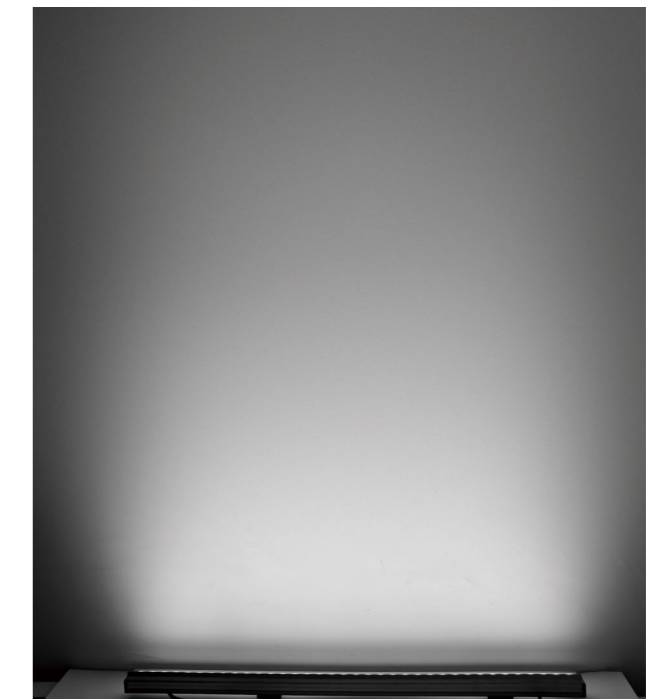
Light Distribution Curve (3000K, 15°40°)



Lux distance Curve (3000K, 15°40°)



Illumination Picture (15x40°)



CE RoHS COMPLIANT IP65 IK04

1 Year Warranty

Parameter

General Data	
Item No.	LWWW-3601-3600B
Power	36W
LED type	36 PCS 1W OSRAM LED
Luminous flux	2700lm
CCT	2700K, 3000K, 4500K, 6000K
CRI	80+
Beam angle	12°/24°/30°/40°/60° or Oval lens 15°40°
Dimension	1000*45*28 mm (Length x Width x Height)
Cut out	/
Net weight	1.75 kgs
Warranty	1 year
Certifications	CE, RoHS
Electrical Data	
Input voltage	DC24V (AC100~265V version optional)
Insulation class	Class III
Cable	2 PCS rubber cables with waterproof connectors, one side male, another side female
Driver	Low voltage constant current output, excluding the transformer
Control	Stand alone
Construction Data	
IP rating	IP65 Waterproof
IK rating	IK04
Housing	Passivated (Anodizing) Aluminium
Protection finishing	20~25µm thickness anodized film for housing. Dark grey
Trim	Aluminium+glass
Glass	Tempered Glass T=4mm
Loading capacity	220kgs
Cable Gland	PG IP65
Gasket	PMQ silicone gasket seal
Accessories	
Bracket	Aluminium bracket
Barn door	Without barn door as standard, and with barn door as options
Packaging	
Inner box size	1068*85*75mm
Carton size	108.5*28*24 cm (6PCS / carton)

CE RoHS COMPLIANT IP65 IK04

1 Year Warranty

Parameter

General Data	
Item No.	LWWW-3601-4800-B
Power	48W
LED type	36 PCS 1.3W OSRAM LED
Luminous flux	3200lm
CCT	2700K, 3000K, 4500K, 6000K
CRI	80+
Beam angle	12°/24°/30°/40°/60° or Oval lens 15°40°
Dimension	1000*45*28 mm (Length x Width x Height)
Cut out	/
Net weight	1.75 kgs
Warranty	1 year
Certifications	CE, RoHS
Electrical Data	
Input voltage	DC24V (AC100~265V version optional)
Insulation class	Class III
Cable	2 PCS rubber cables with waterproof connectors, one side male, another side female
Driver	Low voltage constant current output, excluding the transformer
Control	Stand alone
Construction Data	
IP rating	IP65 Waterproof
IK rating	IK04
Housing	Passivated (Anodizing) Aluminium
Protection finishing	20~25µm thickness anodized film for housing. Dark grey
Trim	Aluminium+glass
Glass	Tempered Glass T=4mm
Loading capacity	220kgs
Cable Gland	PG IP65
Gasket	PMQ silicone gasket seal
Accessories	
Bracket	Aluminium bracket
Barn door	Without barn door as standard, and with barn door as options
Packaging	
Inner box size	1068*85*75mm
Carton size	108.5*28*24 cm (6PCS / carton)





XLINER LIGHTS SERIES

Products Features

These products are designed with structure silicone seal+ glue seal for IP68, anti-corrosion, anti-UV PC cover with Aluminium housing inside +outside Anti-corrosion copper end with excellent heat-conducting make them be able to be used underwater or without water.

They're with CREE LED with LM80 report for long lifetime.

With two brackets as optional for different places.

These products are with CE,RoHS certifications,and the SAA,PSE,UL or ETL certifications will be available in the coming future.

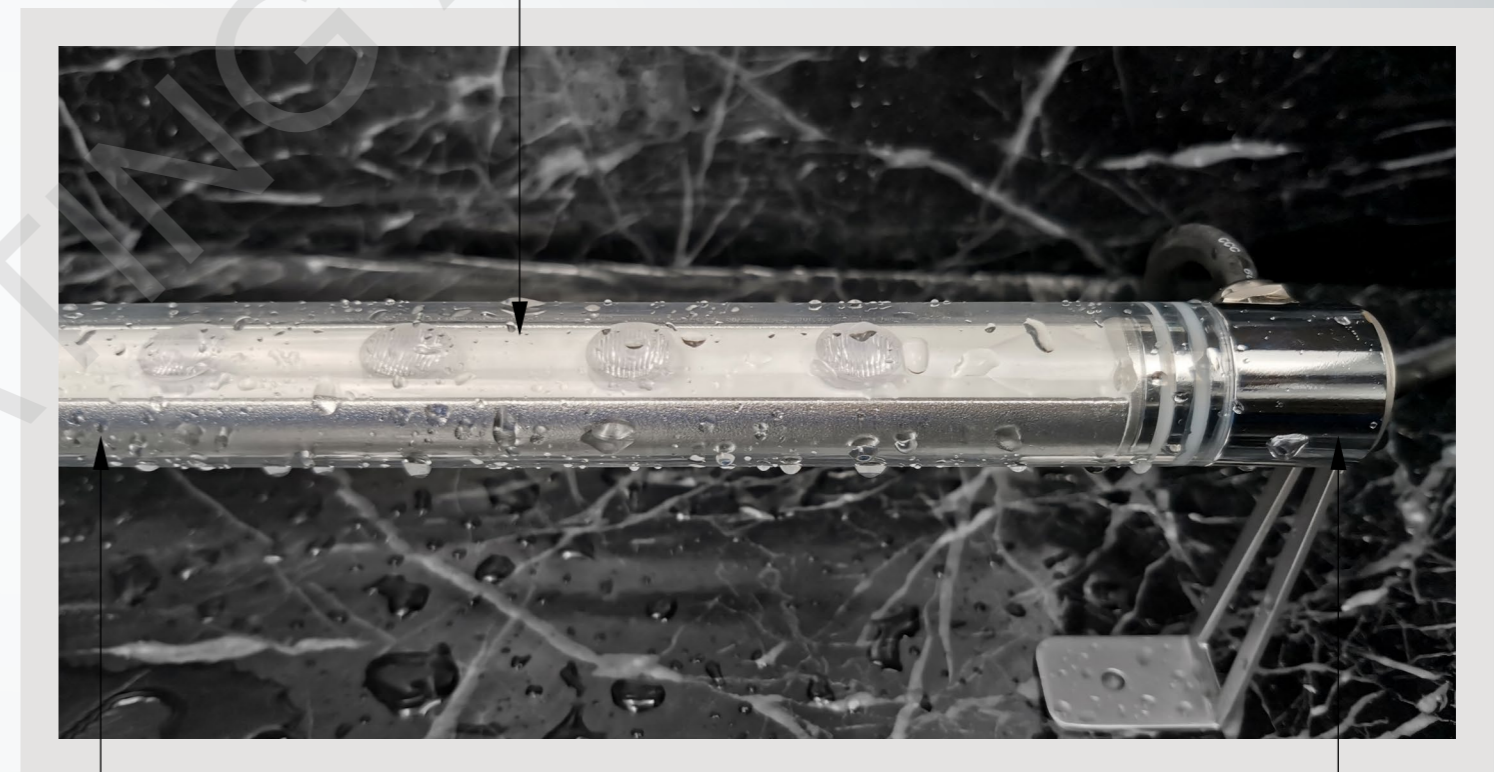
Application

They are ideal for the application of places where should be waterproof or tri-proof, such as pool,bridge, tunnel,bathroom,wall or places of gas station, metro station,workshop etc..

Copper

Passivated

1 Year Warranty

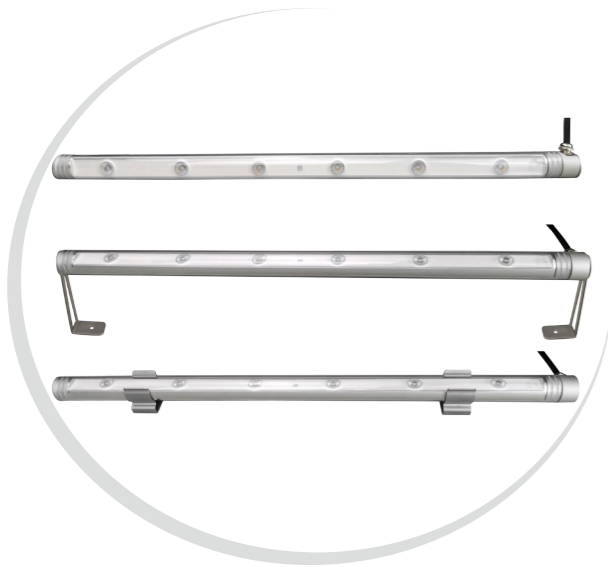


anti-corrosion and anti-UV PC tube cover

Inside PC tube with Aluminium housing
Glue+structrue waterproof IP68

Copper end with good heat dissipation and anti-corrosion
(Aluminium end as options)

Xlinear 6A



CE RoHS COMPLIANT IP68 IK09

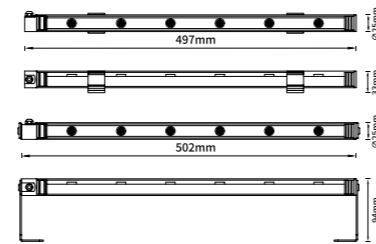
1 Year Warranty

IP68 waterproof for both of underwater or without water
It can be used as underwater linear light or wall washer or tri-proof linear light
Two brackets as options

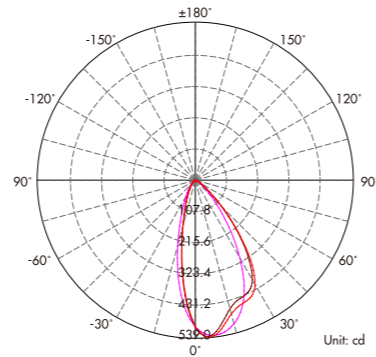
Parameter

General Data	
Item No.	SL-T8-0600-A
Power	6 Watts +10%
LED type	6 PCS CREE XPE LED
Luminous flux	430 lm +10%
CCT	2700K, 3000K, 4000K, 6000K
CRI	80+
Beam angle	15°, 20°, 25°, 30°, 38°, 45°, 60°
Dimension	Ø25x500 (mm) Diameter x length
Cut out	/ mm
Net weight	0.5 kgs
Warranty	1 year
Certifications	CE, RoHS
Electrical Data	
Input voltage	DC24V
Insulation class	Class III
Cable	1PC rubber cable 2M H05RN-F 2x0.5mm square
Driver	Low voltage constant voltage input , constant current output for LED
Construction Data	
IP rating	IP68 Waterproof
IK rating	IK09
Housing	Copper ends (Aluminium ends as options)+PC tube with Aluminium housing inside
Protection finishing	Anodized for Aluminium +Plated for copper
Trim	PC
Glass	/
Loading capacity	/
Cable Gland	PG gland
Gasket	silicone ring + silicone glue seal
Accessories	
Bracket	SS316 bracket 1 or bracket 2 as options
Packaging	
Inner box size	50*30*650 mm
Carton size	67*27.5*14.5 cm (20 PCS/carton)

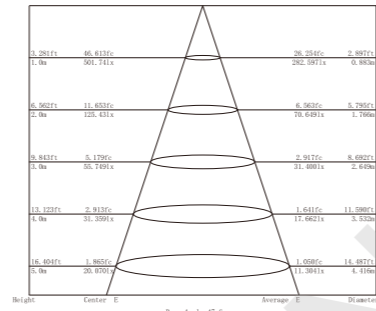
Dimension



Light Distribution Curve (3000K,45°)



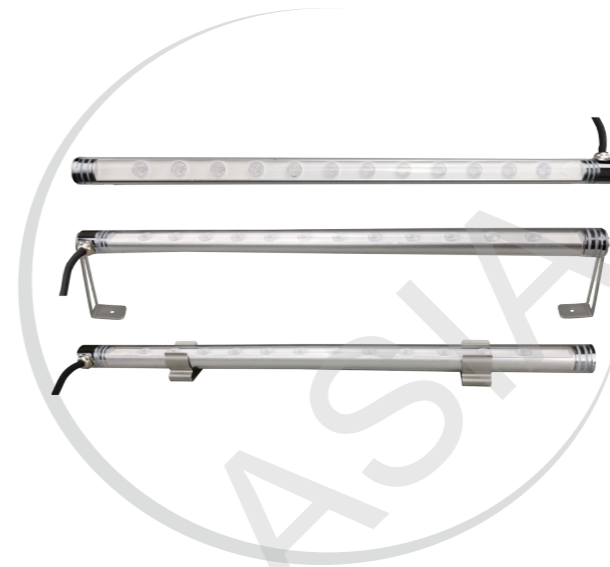
Lux distance Curve (3000K,45°)



Illumination Picture (45°)



Xlinear 12B



CE RoHS COMPLIANT IP68 IK09

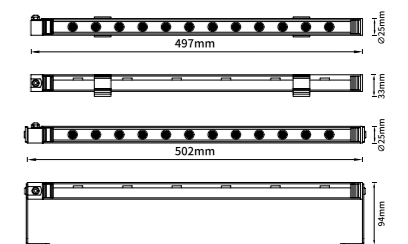
1 Year Warranty

IP68 waterproof for both of underwater or without water
It can be used as underwater linear light or wall washer or tri-proof linear light
Two brackets as options

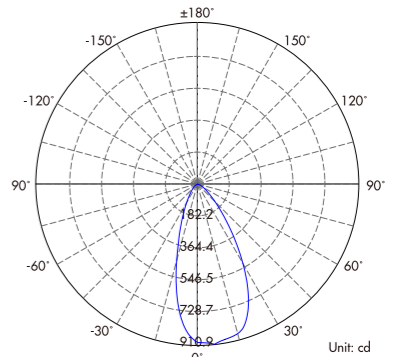
Parameter

General Data	
Item No.	SL-T8-1200B
Power	12 Watts +10%
LED type	12 PCS CREE XPE LED
Luminous flux	800 lm +10%
CCT	2700K, 3000K, 4000K, 6000K
CRI	80+
Beam angle	15°, 20°, 25°, 30°, 38°, 45°, 60°
Dimension	Ø25x500 (mm) Diameter x length
Cut out	/ mm
Net weight	0.5 kgs
Warranty	1 year
Certifications	CE, RoHS
Electrical Data	
Input voltage	DC24V
Insulation class	Class III
Cable	1PC rubber cable 2M H05RN-F 2x0.5mm square
Driver	Low voltage constant voltage input , constant current output for LED
Construction Data	
IP rating	IP68 Waterproof
IK rating	IK09
Housing	Copper ends (Aluminium ends as options)+PC tube with Aluminium housing inside
Protection finishing	Anodized for Aluminium +Plated for copper
Trim	PC
Glass	/
Loading capacity	/
Cable Gland	PG gland
Gasket	silicone ring + silicone glue seal
Accessories	
Bracket	SS316 bracket 1 or bracket 2 as options
Packaging	
Inner box size	50*30*650 mm
Carton size	67*27.5*14.5 cm (20 PCS/carton)

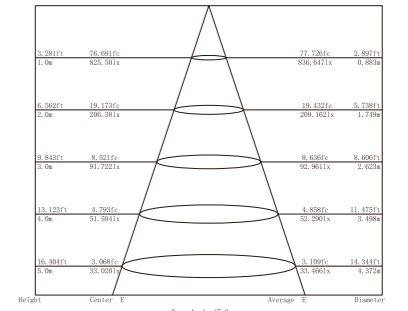
Dimension



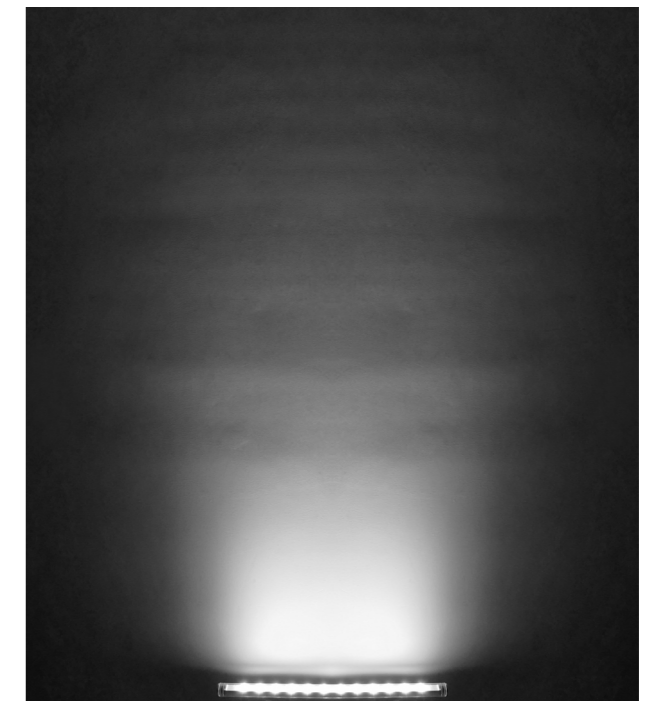
Light Distribution Curve (3000K, 45°)



Lux distance Curve (3000K, 45°)



Illumination Picture (45°)





Xlinear 12C



CE RoHS COMPLIANT IP68 IK09

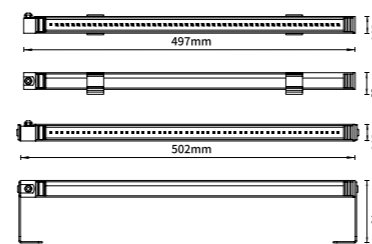
1 Year Warranty

IP68 waterproof for both of underwater or without water
It can be used as underwater linear light or wall washer or tri-proof linear light
Two brackets as options

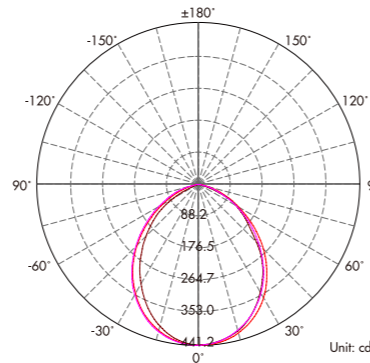
Parameter

General Data	
Item No.	SLT8-1200-C
Power	12 Watts +10%
LED type	54 PCS OSRAM 2835 LED
Luminous flux	900 lm +10%
CCT	2700K, 3000K, 4000K, 6000K
CRI	80+
Beam angle	100°
Dimension	∅25x500 (mm) Diameter x length
Cut out	/ mm
Net weight	0.5 kgs
Warranty	1 year
Certifications	CE, RoHS
Electrical Data	
Input voltage	DC24V
Insulation class	Class III
Cable	1 PC rubber cable 2M H05RN-F 2x0.5mm square
Driver	Low voltage constant voltage input , constant current output for LED
Construction Data	
IP rating	IP68 Waterproof
IK rating	IK09
Housing	Copper ends [Aluminium ends as options]+PC tube with Aluminium housing inside
Protection finishing	Anodized for Aluminium +Plated for copper
Trim	PC
Glass	/
Loading capacity	/
Cable Gland	PG gland
Gasket	silicone ring + silicone glue seal
Accessories	
Bracket	SS316 bracket 1 or bracket 2 as options
Packaging	
Inner box size	50*30*650 mm
Carton size	67*27.5*14.5 cm [20 PCS/carton]

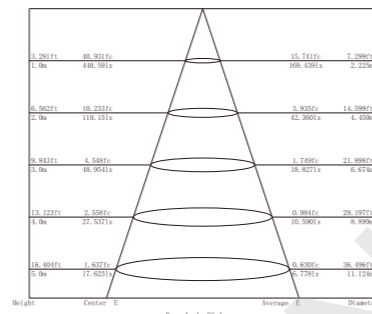
Dimension



Light Distribution Curve (3000K, 100°)



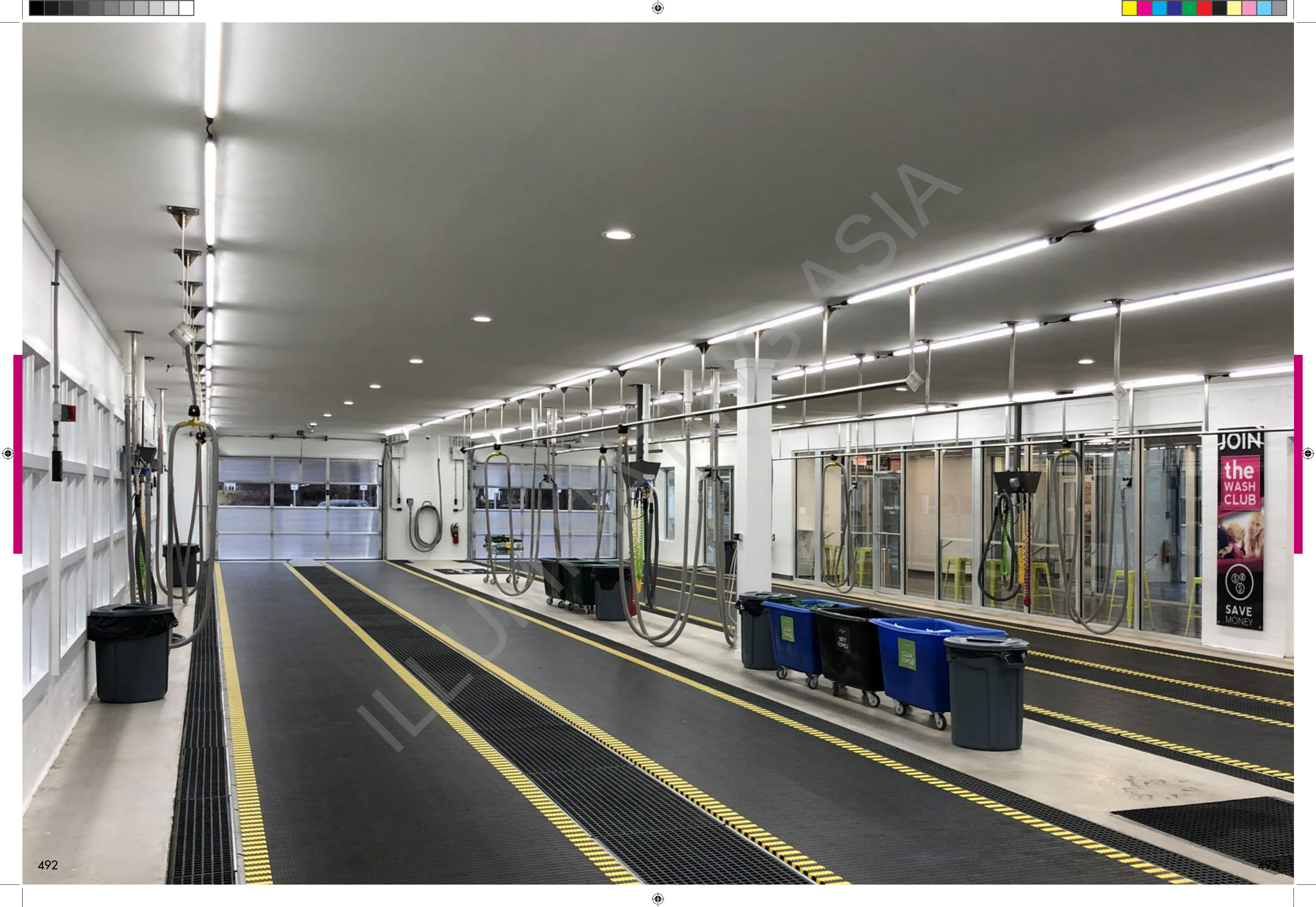
Lux distance Curve (3000K, 100°)



Illumination Picture (100°)











Specialized in Exterior LED Lighting

LED HANDRAIL LIGHTS SERIES

Products Features

These products are designed with stainless steel 316 housing, optics PMMA reflector with wonderful light output, silicone gasket and silicone glue for waterproof IP67 and high quality CREE LED.

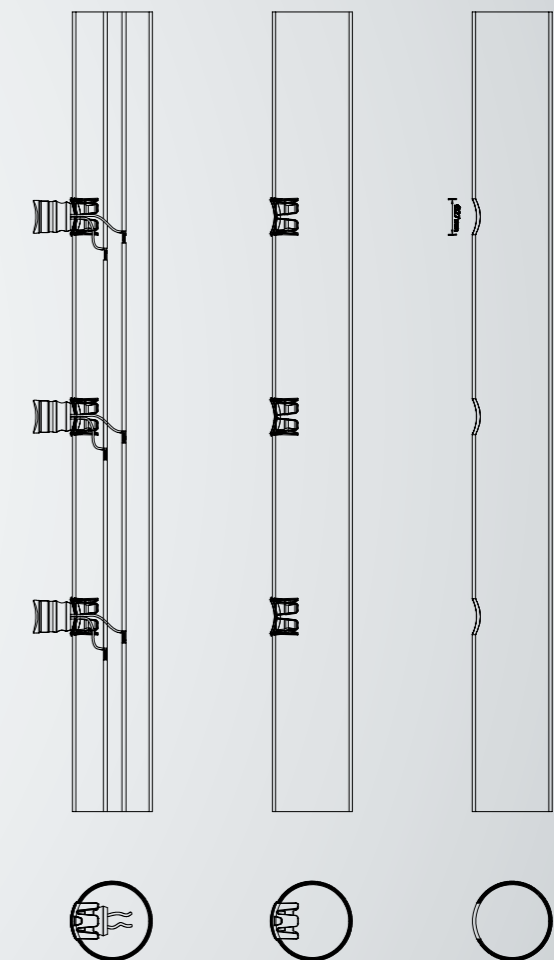
The handrail light DL-1014-0100-A is suitable for standard handrail with $\varnothing 48\sim 60\text{mm}$, and wall thickness of 1~2mm for a $\varnothing 27\text{mm}$ hole, and With PC spring for fast recessed installation.

These handrail lights can be easily and fast retrofitted into existing handrail

These products are with CE, RoHS certifications, and the SAA, PSE, UL or ETL certifications will be available in the coming future.

Application

These lights are widely used in the exterior or interior handrail in multiple places, such as handrail at the house, handrail in the metro, handrail in the gallery, handrail for the stair etc.



SSS 316

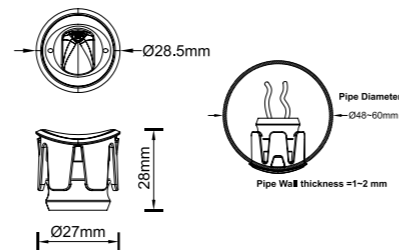
1 Year Warranty

CE  IP67 IK06

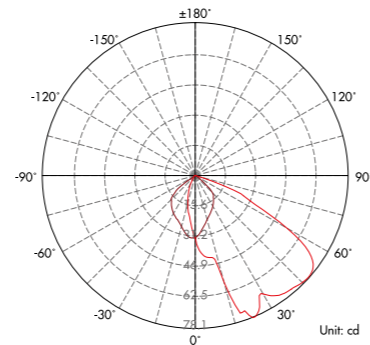
ILLUMINATING ASIA



Dimension



Light Distribution Curve (3000K, 30°x60°)

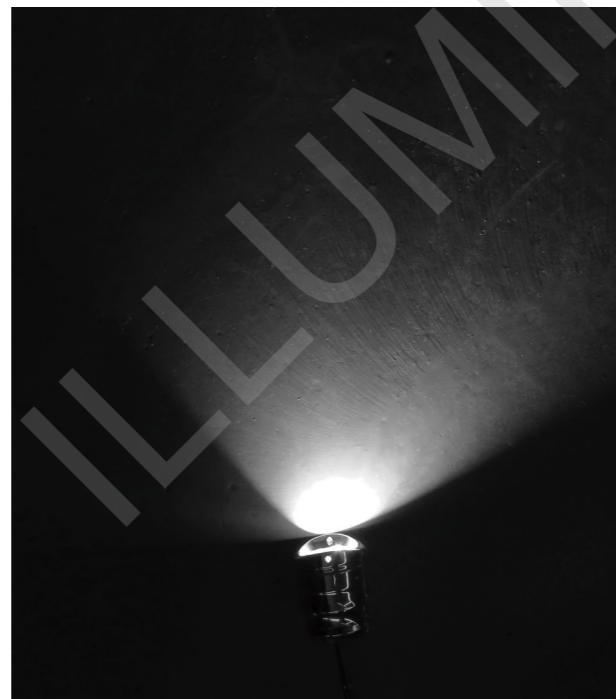


Lux distance Curve (3000K, 30°x60°)

3.281ft	3.003ft	2.117ft	3.726ft
1.0m	32.32lx	22.790lx	1.136m
6.562ft	0.751ft	0.529ft	7.453ft
2.0m	8.080lx	5.698lx	2.272m
9.843ft	0.334ft	0.235ft	11.179ft
3.0m	3.591lx	2.532lx	3.407m
13.123ft	0.188ft	0.132ft	14.906ft
4.0m	2.020lx	1.424lx	4.543m
16.404ft	0.120ft	0.085ft	18.632ft
5.0m	1.293lx	0.912lx	5.679m

Height Center E Beam Angle: 59.2 Average E Diameter

Illumination Picture (30°x60°)



CE RoHS COMPLIANT IP67 IK06

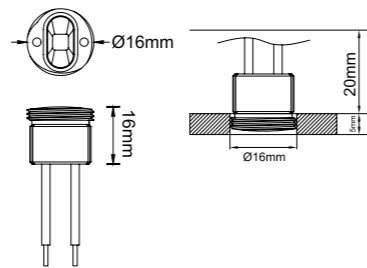
SSS 304 1 Year Warranty

Parameter

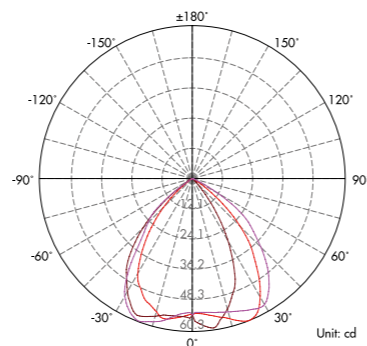
General Data	
Item No.	SSS304: DL-10140100-A-304 / Alu: DL-10140100-A-6063
Power	1.5 watts +10%
LED type	1 PC 1W CREE XPE LED
Luminous flux	76-95 lm
CCT	2700K, 3000K, 4000K, 5000K, 6000K
CRI	80+
Beam angle	30°x60° (Tilt x Pan)
Dimension	28.5 x 28 (mm) Diameter x Height
Cut out	27
Net weight	0.048kgs
Warranty	1 year
Certifications	CE, RoHS
Electrical Data	
Input voltage	DC 12V / DC 24V
Insulation class	Class III
Cable	1PC teflon cable 0.25M 2*0.3mm square
Driver	low voltage constant current output, excluding the transformer
Construction Data	
IP rating	IP67 Waterproof
IK rating	IK06
Housing	Stainless steel 304 for 304 version / Aluminium for 6063 version
Protection finishing	Stainless steel 304 for 304 version / Silver color Anodizing Aluminium for 6063 version
Trim	Stainless steel 304 for 304 version / Silver color Anodizing Aluminium for 6063 version
Glass	/
Loading capacity	110 kgs
Cable Gland	/
Gasket	O-ring PMQ silicone seal
Accessories	
Spring	PC spring for recessed installation
Clip	SS304 clip for taking off the fixture from the handrail
Packaging	
Inner box size	60*60*40 mm
Carton size	32.5*26*22 cm (100PCS / carton)



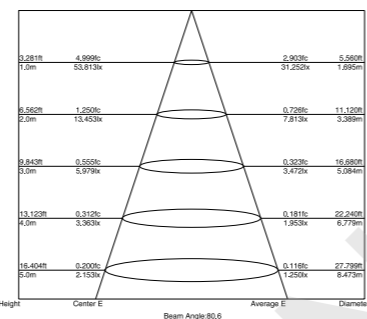
Dimension



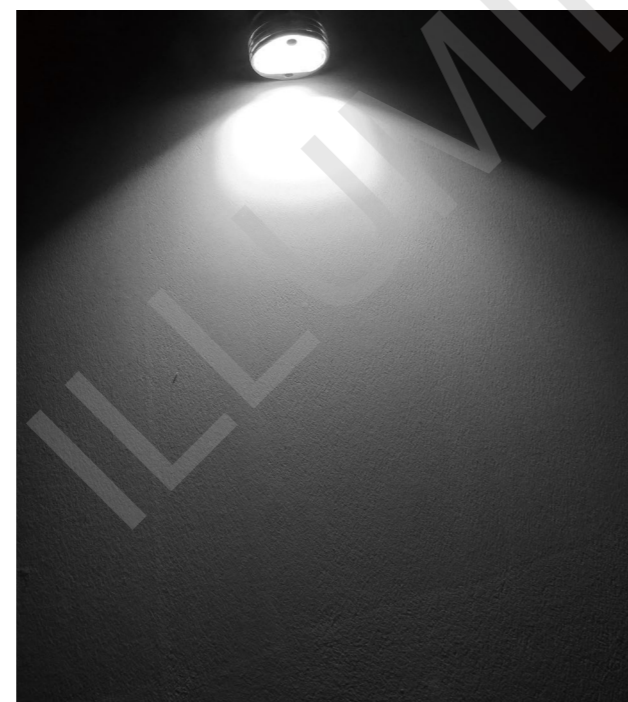
Light Distribution Curve (3000K, 80°)



Lux distance Curve (3000K, 80°)



Illumination Picture (80°)



CE RoHS COMPLIANT IP67 IK06

1 Year Warranty

Parameter

General Data	
Item No.	80°: DL-1016-0100A / 10x60°: DL-1016-0100B
Power	1W+10%
LED type	1 PC CREE XPG LED
Luminous flux	70 lm +10%
CCT	2700K, 3000K, 4000K, 6000K
CRI	80+
Beam angle	80° for DL-1016-0100A / Asymmetrical 10x60° for DL-1016-0100B
Dimension	16 x 16 (mm) (Diameter x Height)
Cut out	16mm
Net weight	0.02 kgs
Warranty	1 year
Certifications	CE, RoHS
Electrical Data	
Input voltage	DC3V 350mA constant current
Insulation class	Class III
Cable	1PC teflon cable 0.25M 2*0.3mm square
Driver	without driver, need external constant current driver
Construction Data	
IP rating	IP67 Waterproof
IK rating	IK06
Housing	Chrome Plated Copper CNC machined
Protection finishing	Chrome Plated
Trim	Chrome Plated Copper CNC machined
Glass	/
Loading capacity	110 kgs
Cable Gland	/
Gasket	/
Accessories	
Clip	SS304 clip for installation or taking off the fixture from the handrail
Packaging	
Inner box size	60*60*40mm
Carton size	32.5*26*22 cm (100 PCS / carton)







ACCESSORIES SERIES

Products Features

These connectors are designed with anti-corrosion and strong enough nylon materials, and they are IP68 waterproof.

Especially the IP67 inground lights that must be used with the IP67 or IP68 waterproof connectors or junction boxes. Due to the moisture or water will come into the lighting fixtures through the wires if they aren't connected by IP67 or IP68 waterproof connectors or junction boxes.

Application

They are recommended to be used for our IP67 inground lights, IP68 underwater lights, IP65/IP67 garden spot lights.



1 Year Warranty

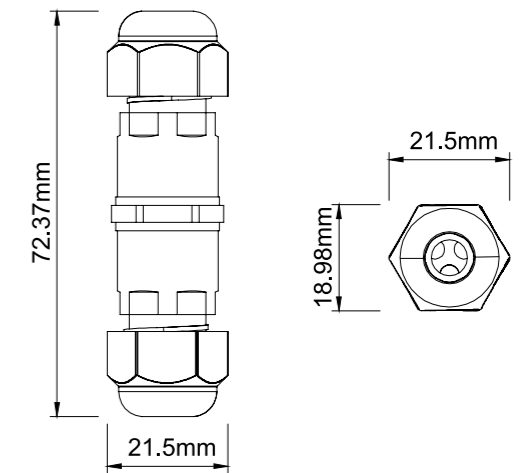
IP68 IK09 IK10



IP68 IK10

1 Year Warranty

Dimension

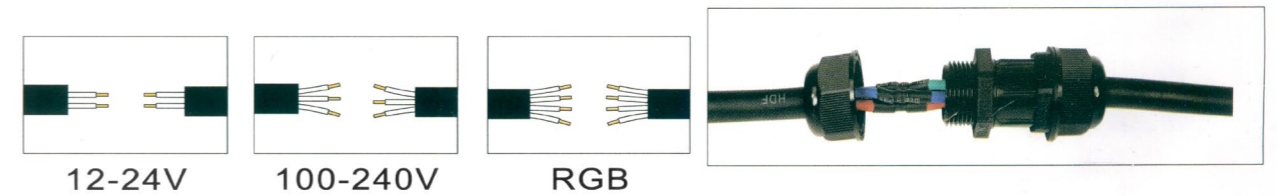


Parameter

General Data	
Item No.	VRCA-I
For cable	Min. 2 or 3x0.5mm ² , Max. 2 or 3x1 mm ² (For 2pins or 3 pins)
For cable diameter	Diameter 5mm~7.5mm
Terminal block	2 or 3 poles. Screws fixing
Dimension	21.5x72.37mm (Length x Diameter)
Net weight	0.02 kgs
Warranty	3 years
Electrical Data	
Voltage range	9A 450v @ max. It's usually for both of DC12V~DC24V or AC100~240V. single color
Construction Data	
IP rating	IP68
IK rating	IK10
Housing	Nylon materials PA66, V2
Pole	2 or 3 poles, Copper, nickel plated.
Gasket	PMQ silicone gasket seal

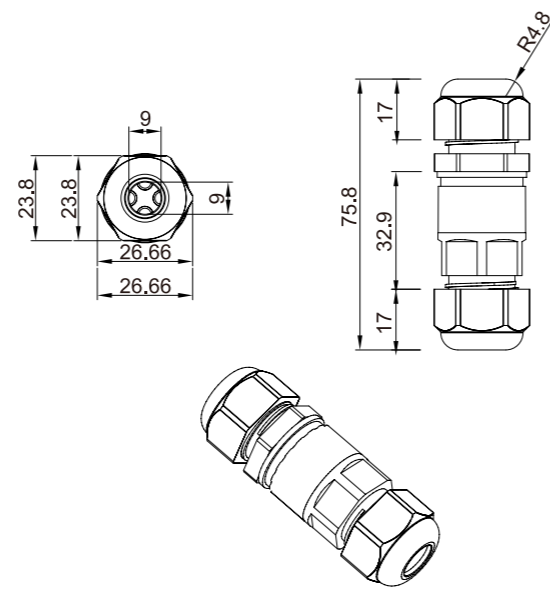
Parallel Circuit Connecting Drawing

Wiring Diagram





Dimension



IP68 IK10

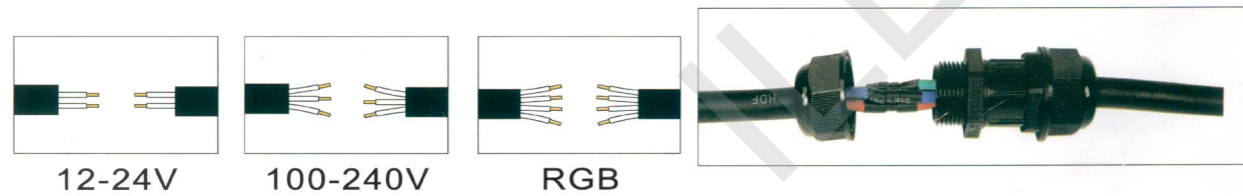
1 Year Warranty

Parameter

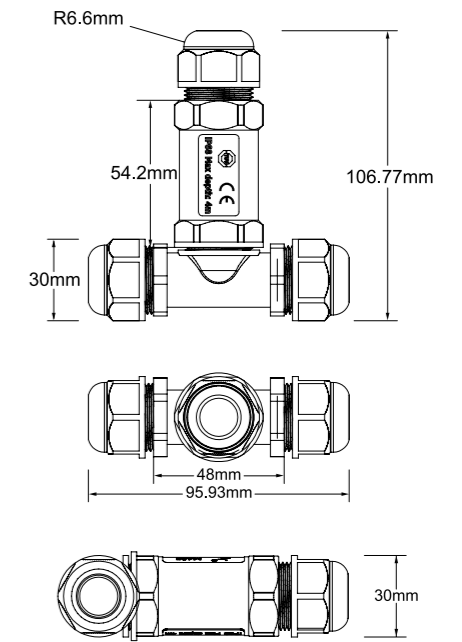
General Data	
Item No.	WRCA-I (I)
For cable	Min. 2 or 3 or 4 x0.5mm ² /Max. 2 or 3 or 4 x1.5mm ² (For 2 pins or 3 pins or 4 pins)
For cable diameter	9mm~12mm as standard. (5~9mm as optional according to the order)
Terminal block	2 or 3 or 4 poles. Screws fixing
Dimension	23.8x75.8mm (Diameter x Length)
Net weight	0.03 kgs
Warranty	1 year
Electrical Data	
Voltage range	24A,450v @ max. It's usually for both of DC12V~DC24V or AC100~240V. single color or RGB or RGBW lighting fixture
Construction Data	
IP rating	IP68
IK rating	IK10
Housing	Nylon materials PA66, V2
Pole	2 or 3 or 4 poles,Copper, nickel plated.
Gasket	PMQ silicone gasket seal

Parallel Circuit Connecting Drawing

Wiring Diagram



Dimension



IP68 IK10

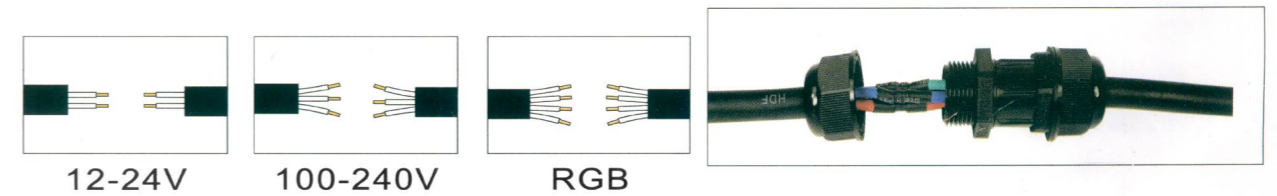
1 Year Warranty

Parameter

General Data	
Item No.	WRCA-T
For cable	Min. 0.5mm ² max. 4mm ²
For cable diameter	Diameter 4mm~8mm as standard (8~12mm or 10~14mm as optional according to the order)
Terminal block	2 or 3 or 4 or 5 poles as options. Screws fixing
Dimension	95.93x106.77mm (Width x Length)
Net weight	0.06 kgs
Warranty	5 years
Electrical Data	
Voltage range	24A,450v @ max. It's usually for both of DC12V~DC24V or AC100~240V. single color or RGB or RGBW lighting fixture
Construction Data	
IP rating	IP68
IK rating	IK10
Housing	Nylon materials PA66, V2
Pole	2 or 3 or 4 or 5 poles,Copper, nickel plated.
Gasket	PMQ silicone gasket seal

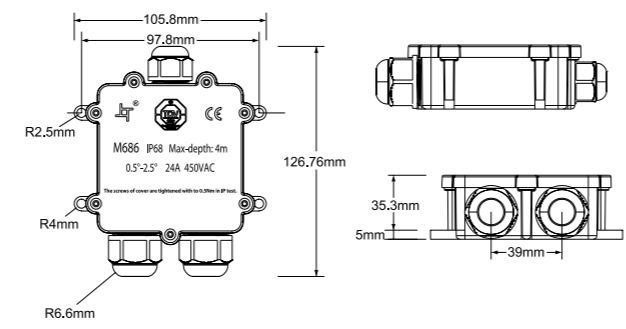
Parallel Circuit Connecting Drawing

Wiring Diagram





Dimension



Parameter

General Data	
Item No.	WRCC-Box
For cable	Min. 0.5mm ² max. 4mm ²
For cable diameter	Diameter 4mm~8mm as standard (8~12mm or 10~14mm as optional according to the order)
Terminal block	2 or 3 or 4 or 5 poles as options . Screws fixing
Dimension	95.93x106.77mm (Width x Length)
Net weight	0.08 kgs
Warranty	1 year
Electrical Data	
Voltage range	24A,450v @ max. It's usually for both of DC12V~DC24V or AC100~240V. single color or RGB or RGBW lighting fixture
Construction Data	
IP rating	IP68
IK rating	IK10
Housing	Nylon materials PA66, V2
Pole	2 or 3 or 4 or 5 poles, Copper, nickel plated.
Gasket	PMQ silicone gasket seal
Accessories	
Mounting Sleeve	Passivated (Anodizing) Aluminium
Packaging	
Inner box size	95*95*132 mm
Carton size	40.5*40.5*28 cm (32PCS / carton)

IP68 IK10

1 Year Warranty

ACCESSORIES

Parallel Circuit Connecting Drawing

Connection Demo

